

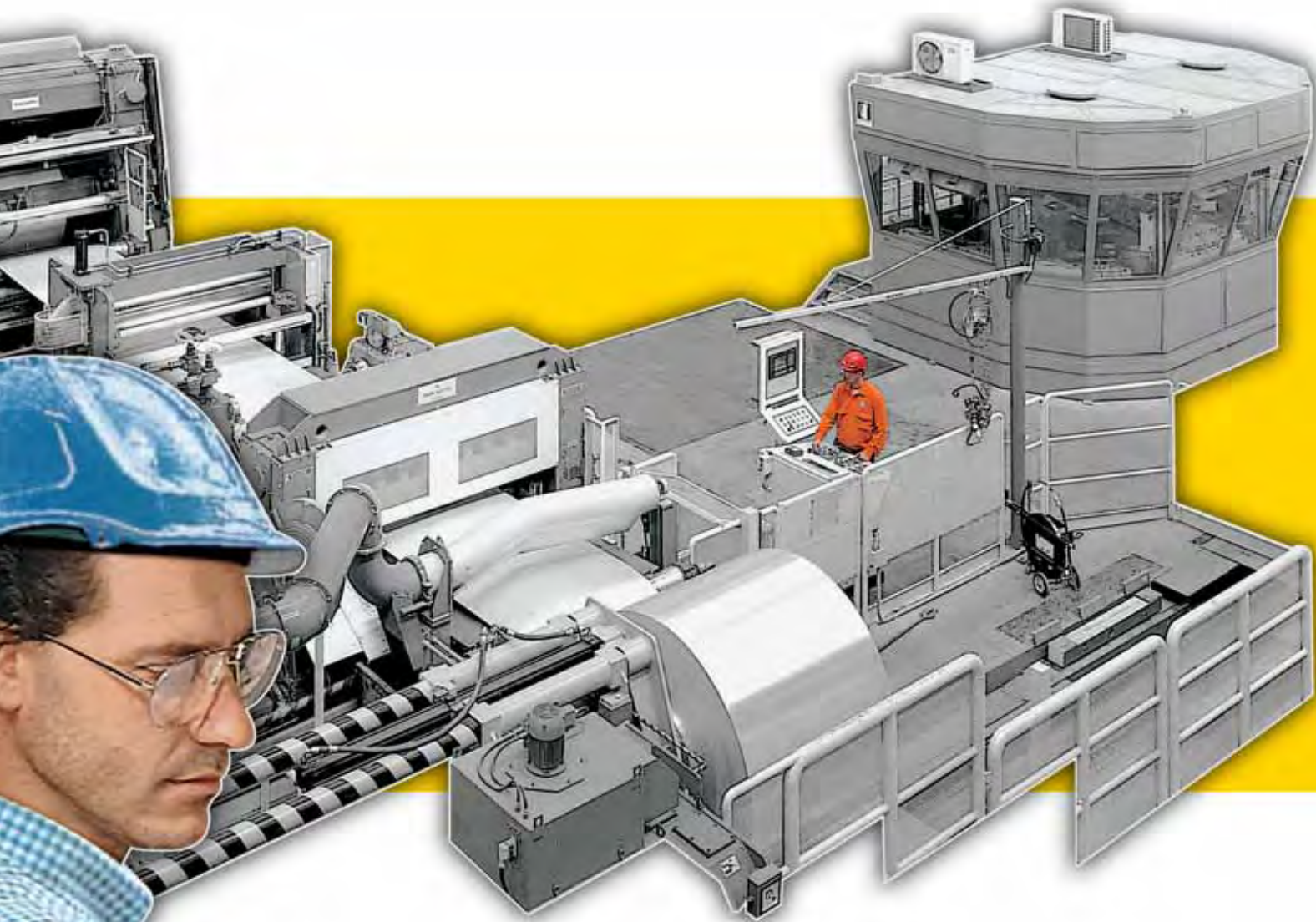

STOCKAL[®]

Prepainted
aluminium
rolled
products
for building
and industrial
applications





Novelis is the world leader in aluminum rolling, producing an estimated 19 percent of the world's flat-rolled aluminum products. They are the N°. 1 rolled products producer in Europe, South America and Asia, and the N°. 2 producer in North America. Novelis is globally positioned, operating in 11 countries with approximately 12,900 employees. Formed as a Canadian corporation in January 2005, Novelis is a wholly owned subsidiary of Hindalco Industries Limited - Asia's largest integrated producer of aluminium and a leading producer of copper. Based in Mumbai, India, Hindalco is one of the most cost-efficient aluminium producers globally.

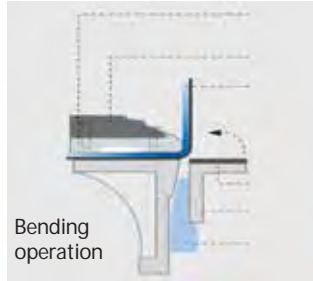
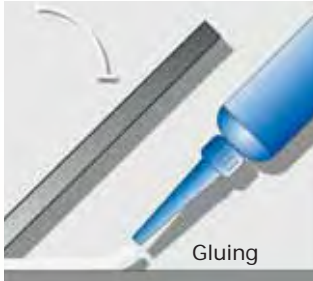
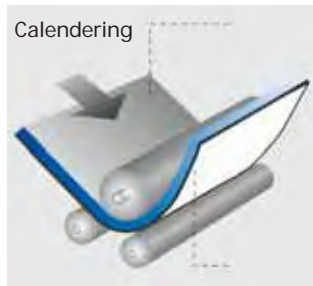

STOCKAL® is characterised by an extraordinary degree of workability. Thanks to its chemical and mechanical characteristics, due to the combination of a EN AW 5010 alloy and polyester based liquid paints, STOCKAL® can be easily worked using the main mechanical working processes: bending, drilling, milling and cutting; these are only part of the standard working processes for STOCKAL®. The use of a special protective liquid coating on the reverse side makes STOCKAL® also suitable for gluing and bonding.

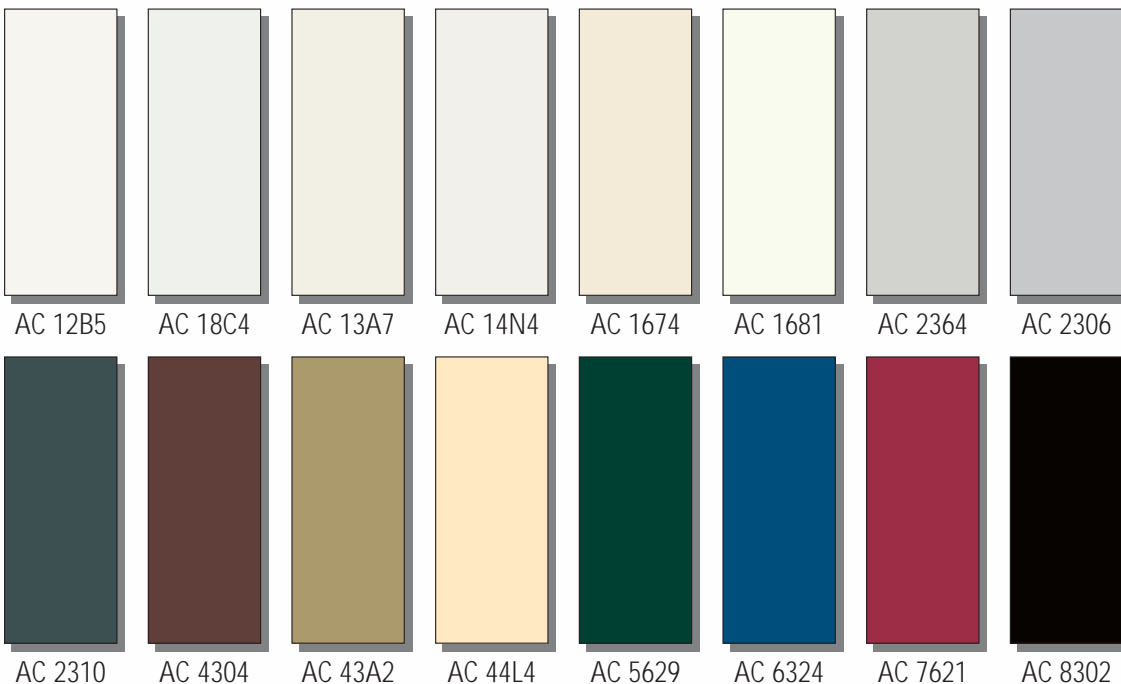

This colour chart includes proposals of pre-painted aluminium colours available in matt, demi and high gloss versions. It is possible to realise pre-painted aluminium coils on sample bases. The colours are as close as printing technique allows. We suggest to ask for an original painted aluminium sample.

Technical Sheet - STOCKAL®			
Product description			Norms
Aluminium alloy:	-	UNI-EN AW-5010	UNI-EN 573/3
Metal gauge:	[mm]	1.00 - 2.00	
Temper:	-	H42	int. standards
Coating top side:	-	Polyester paint	int. standards
Backing coat:	-	Protective lacquer	int. standards
Metal specification			Norms
Mechanical properties after coating - transverse to rolling direction			int. standards
Rm:	[MPa]	110 - 150	
Rp0.2:	[MPa]	90 min	
A50:	[%]	5 min from 1.00 mm up to 1.50 mm	
		6 min over 1.50 mm up to 2.00 mm	
Tolerance on dimensions:		Gauge	UNI-EN 485/4
		Width and Length	UNI-EN 485/4

CERTIFICATES

Health and Safety

Management System:

BSI OHSAS 18001; 1999

Environment Management System Certificate:

EN ISO 14001; 2004

Quality Management System Certificate:

EN ISO 9001; 2000

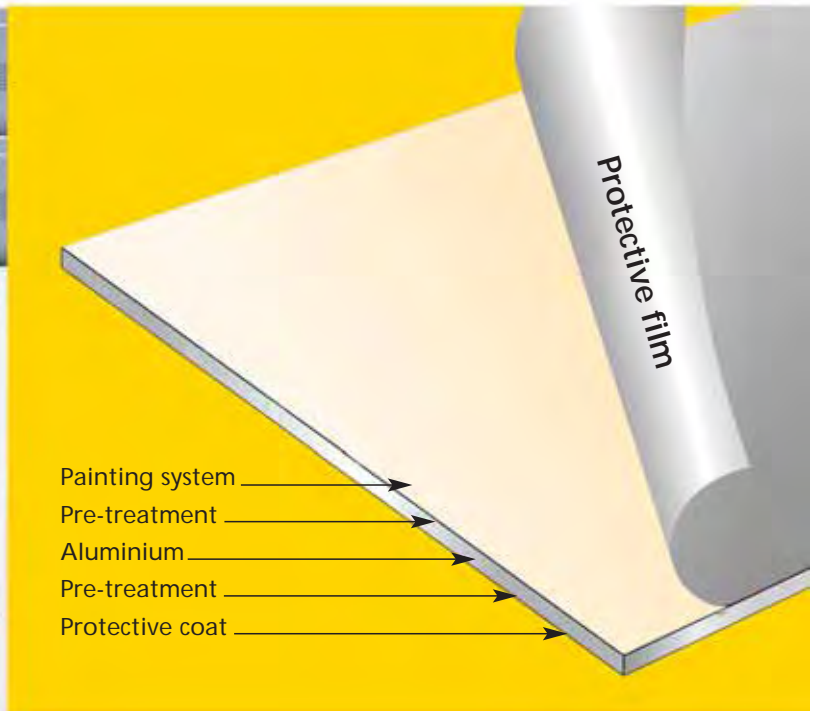

Technical Sheet - STOCKAL®			
Pre-treatment			
Degreasing and chromium free treatment on top and reverse side			
Organic coating specification (ECCA and UNI-EN 1396)		Top side	Backing coat
Coating system:		Polyester	Polyester
Typical coating thickness:	ECCA T1	22	4 approx.
Pencil hardness:	ECCA T4	H	not relevant
Specular gloss to 60°:	ECCA T2	10 - full gloss	30 - full gloss
Adhesion 90°/180°:		100	not relevant
Adhesion on cross hatch + impact:		100	100
M.E.K. / Solvent rubbing test:	ECCA T11	150	> 50
Resistance to craking on bending:	ECCA T7	1.0 T from 1.00 mm up to 1.20 mm	
		1.5 T over 1.20 mm up to 1.50 mm	
		2.0 T over 1.50 mm up to 2.00 mm	

Novelis Group is an important entity in Italy, too. There are two plants near Milan - Bresso and Pieve Emanuele. Novelis' Bresso plant produces prepainted rolled products using a range of paints and surface finishes. Pieve plant produces aluminium coil and sheet. It is equipped with casters and cold rolling facilities.

Novelis is present throughout the whole Italian market thanks to its four sales centres in Verona, Bologna, Florence and Rome.

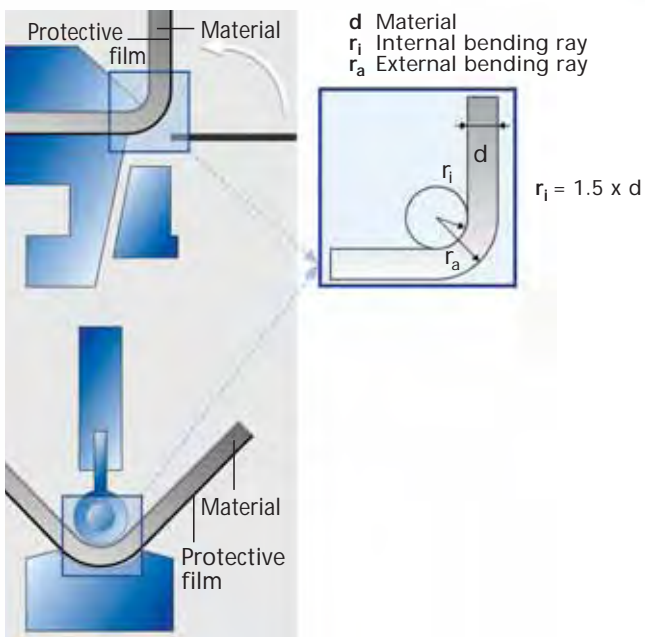

STOCKAL® is the Novelis brand name for its aluminium sheet prepainted with polyester based liquid paints. STOCKAL® is eminently suitable for use in the building industry, especially for façade cladding and window flashings. The wide range of colours and the extraordinary workability of the aluminium substrate make STOCKAL® the most versatile material produced by Novelis.

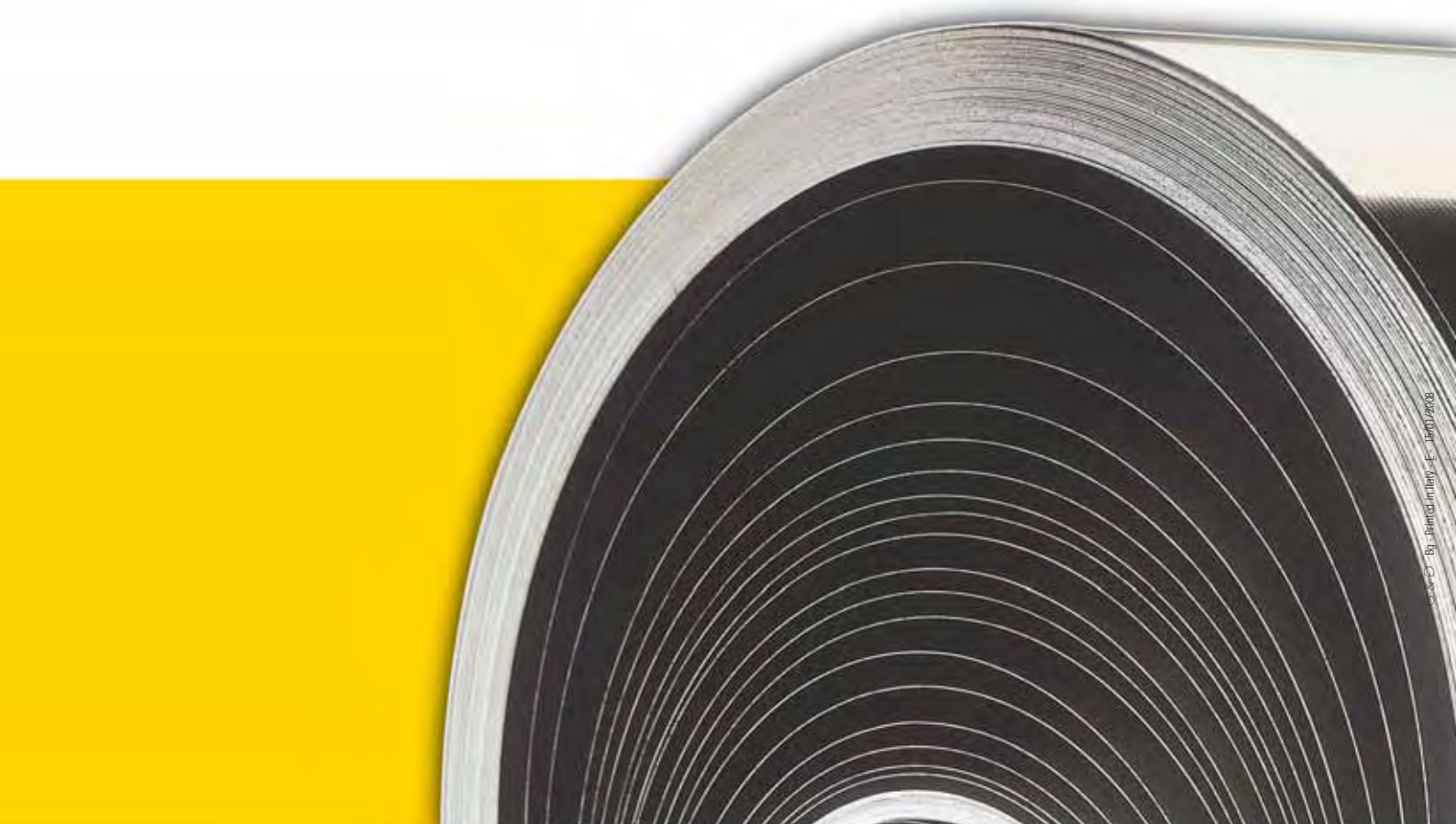

Copyright © 2003 - Printed in Italy - E-1601/2003

Novelis Italia

Via V. Veneto, 106
20091 Bresso (MI)

Tel.: ++39 02 61454.1
Fax: ++39 02 61454.208
e-mail: info.bresso@novelis.com
web: www.novelispaainted.com

The picture utilized in the brochure are from Novelis archive. Novelis maintains the right to update and modify the contents of this product description at any time.