

Emergency Lighting

daisalux

Index

A day in Daisalux	3
New technological developments	15
Central TMA	16
Centralized DaisaTest System	18
Daisa program Versión 4.0	22
General Catalogue	25
Emergency Luminaires	
Nova Series	26
Single Argos Series	34
Double Argos Series	42
Built-in Argos Series	50
Hydra Series	58
Myra Series	66
Norma Series	74
Iris Series	82
Sol Series	90
Luna Series	98
Explosion Proof Series	106
Sealed fluorescent screens	166
Emergency Spotlights	
Zenit Series	114
Zenit PL Series	122
Signalling luminaires	
Vir Series	130
Beacon lighting	
Lyra Series	136
Aqua Series	144
PBL units for supplying beacon models: (Lyra-Aqua)	152
Sherpa Series	154
PBS units for supplying beacon models: (Sherpa/C)	162
Rechargeable torches	164
Emergency kits	168
Electronic ballasts	170
T13-S/T13 Units	172
Centralized DNH Units	174
Centralized DINN Units	176
Centralized DEN Units	178
Luminaires and Specials	180
Control Systems	
Remote Controls	182

A day in Daisalux















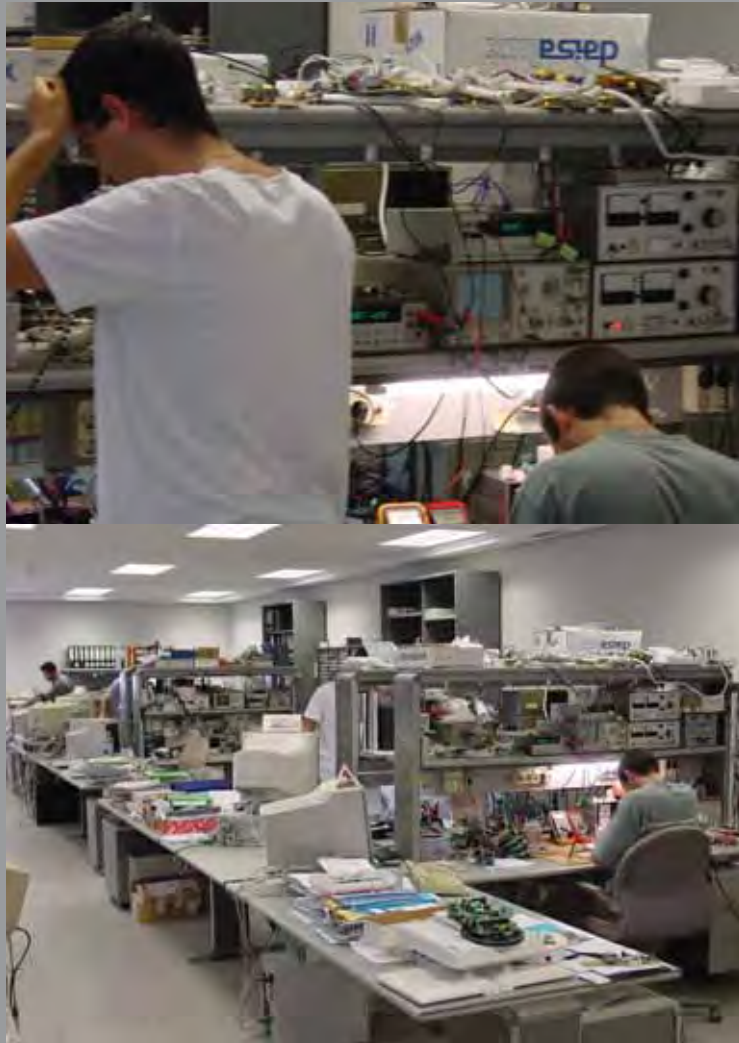

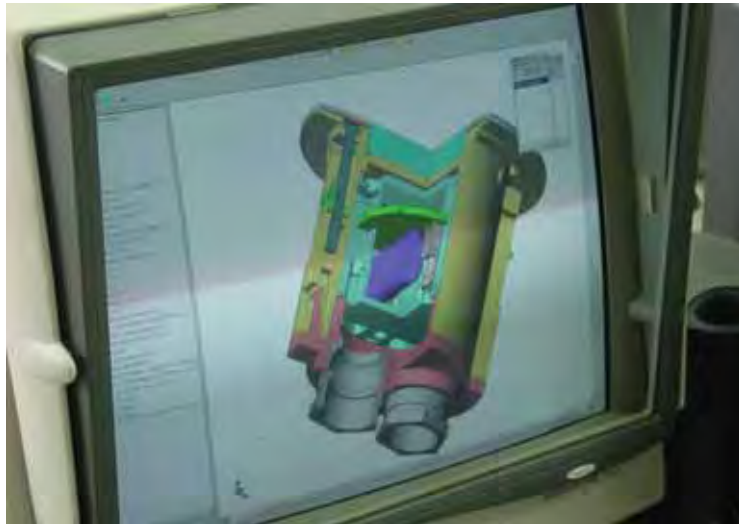



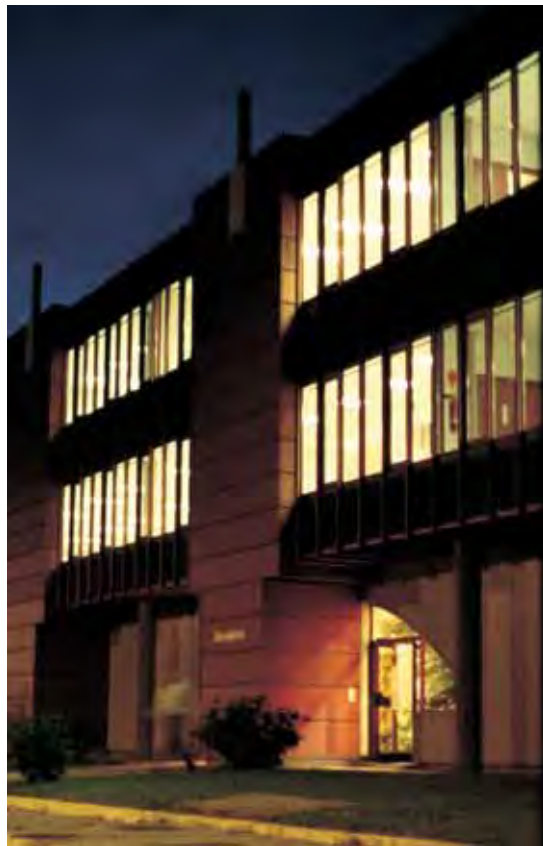

New technological developments

Central TMA

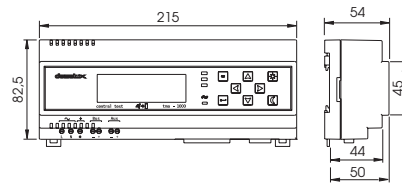

Central TMA

Model	Operation	Number of units
Central TMA-300	Test equipment and remote control which communicates via a two-wire BUS with the Daisalux TCA series self-contained luminaires. Not connected to a computer. Has a parallel port to printer.	300
Central TMA-500	Test equipment and remote control which communicates via a two-wire BUS with the Daisalux TCA series self-contained luminaires The installation is controlled from a local or remote computer.	500
Central TMA-1000	Test equipment and remote control which communicates via a two-wire BUS with the Daisalux TCA series self-contained luminaires. The installation is controlled from a local or remote computer.	1.000

Accessories

Reference:	Description
BUS-TAM 100 m.	Hose made up of two white - red conductors with a cross-section of 1,5 mm ² . For the communication line between TMA CONTROL CENTRAL and TCA appliances. Line of halogens for the communication line between TMA. Length 100 metres. (* Approximate price: may vary according to the price of the raw material.
BUS-TAM 500 m.	Hose made up of two white-red conductors with a cross-section of 1,5 mm ² . For the communication line between TMA CONTROL CENTRAL and TCA appliances. Line of halogens for the communication line between TMA. Length 500 metres. (* Approximate price: may vary according to the price of the raw material.
SBT-200	Isolating switch of the BUS for connecting a maximum of 200 luminaires. Enables checking of the secondary BUS lines used for communication between the TMA control central and the TCA series luminaires. The isolating switch optocouples the bus signal between the main line and the secondary line, thus protecting the installation from potential errors and making it easier to detect errors.
AL-IM	Extension for transferring the Sub D25 connector (printer output) of the TMA-300 control central to the panel (exclusive for TMA-300 control central).

Communication: TMA-500 and TMA-1000 control centrals with PC

Reference:	Description
RS232 connection KIT-RS232	TMA - Computer communication via RS-232 (distance under 25 m). One is needed for each control central. The KIT includes an optocoupler (OPTO-RS232) that electrically insulates the computer from the control central and a 10-m-long connection cable (C10-RS232). NOTE: If a longer cable is needed, more cables can be requested to join them without exceeding the distance of 25 m. (10-m cable - Ref: C10-RS232, and 3-m cable - Ref: C3-RS232).
Ethernet connection KIT-ETH	TMA - Computer communication via local network. One is needed for each control central. The KIT includes an Ethernet adapter (Ref.: ADAP-ETH), power source (Ref.: FA-ETH), connection cable (Ref.: CA2-RS232), anchor for DIN rail (Ref.: A-DIN) and socket for DIN rail (Ref.: E-DIN). NOTE: The network administrator must reserve a fixed IP address for each control central.
GSM/GPRS connection KIT-GSM/GPRS-TMA	TMA - Computer communication via telephone connection (GSM or GPRS). One is needed for each control central. The KIT includes an RS232/GSM-GPRS adapter (Ref.: ADAP-GSM/GPRS), power source (Ref.: FA-GSM/GPRS), antenna (Ref.: ANT-GSM/GPRS), anchor for DIN rail (Ref.: A-DIN), socket for DIN rail (Ref.: E-DIN) and crossed connection cable (Ref.: CCA2-RS232). NOTE: It is the responsibility of the user to purchase the telephone card for the module. This card will only receive calls.
KIT-GSM/GPRS-PC	TMA - Computer communication via telephone connection (GSM or GPRS). One is needed for each computer. The KIT includes an RS232/GSM-GPRS adapter (Ref.: ADAP-GSM/GPRS), power source (Ref.: FA-GSM/GPRS), antenna (Ref.: ANT-GSM/GPRS) and RS-232 communication cable (Ref.: C3-RS232). NOTE: It is the responsibility of the user to purchase the telephone card for the module. This card will only make calls.
PC-DT	Control computer with DaisaTest software installed. The minimum system requirements are: 1 GHz, 256 Mb RAM, CD-ROM, network card, serial port and Windows operating system. NOTE: For GSM/GPRS communication, the computer must have the GSM/GPRS-PC KIT installed.
PM-500	Setting up the control computer for each TMA-500 control central. Includes: Installing the accessories for communication between the control centrals and the computer and the DaisaTest program. Entering the serial numbers of the installed luminaires in DaisaTest. Functional test of the installation with deviation report. Training maintenance staff.
PM-1000	Setting up the control computer for each TMA-1000 control central. Includes: Same as Set up-500.

Constructional data: Synthetic materials, 850°C to EN 60598-1 (IEC 60598-1) and EN 60695-2-1 (IEC 60695-2-1), according to models / Coordinates the messages between the control computer and every unit connected to its communication line (BUS) (TMA-1000) / BUS: communication line consisting of two polarized conductors, one red and the other black, with 1.5 mm² section / Maximum length of BUS cable between central and unit: 1000 metres / Enables the status of the system to be known at all times / Informs of battery shorted or low voltage / Informs of low battery capacity (autonomy failure) / Informs of damaged tube / Informs of electronics or EEPROM memory failure / Informs of correct communication / Informs of correct mains connection / Performs functions of a conventional remote control, NIMH battery, 12 Vdc, 0.140 Ah / **IP 42 IK 02** (must be installed in a switchboard) / Supply voltage 230V 50Hz (maximum consumption: < 6W) / Connection to Fire Protection Systems / Connection to computer via DaisaTest electronic system by means of RS232 series cable (TMA-1000).

New DaisaTest System

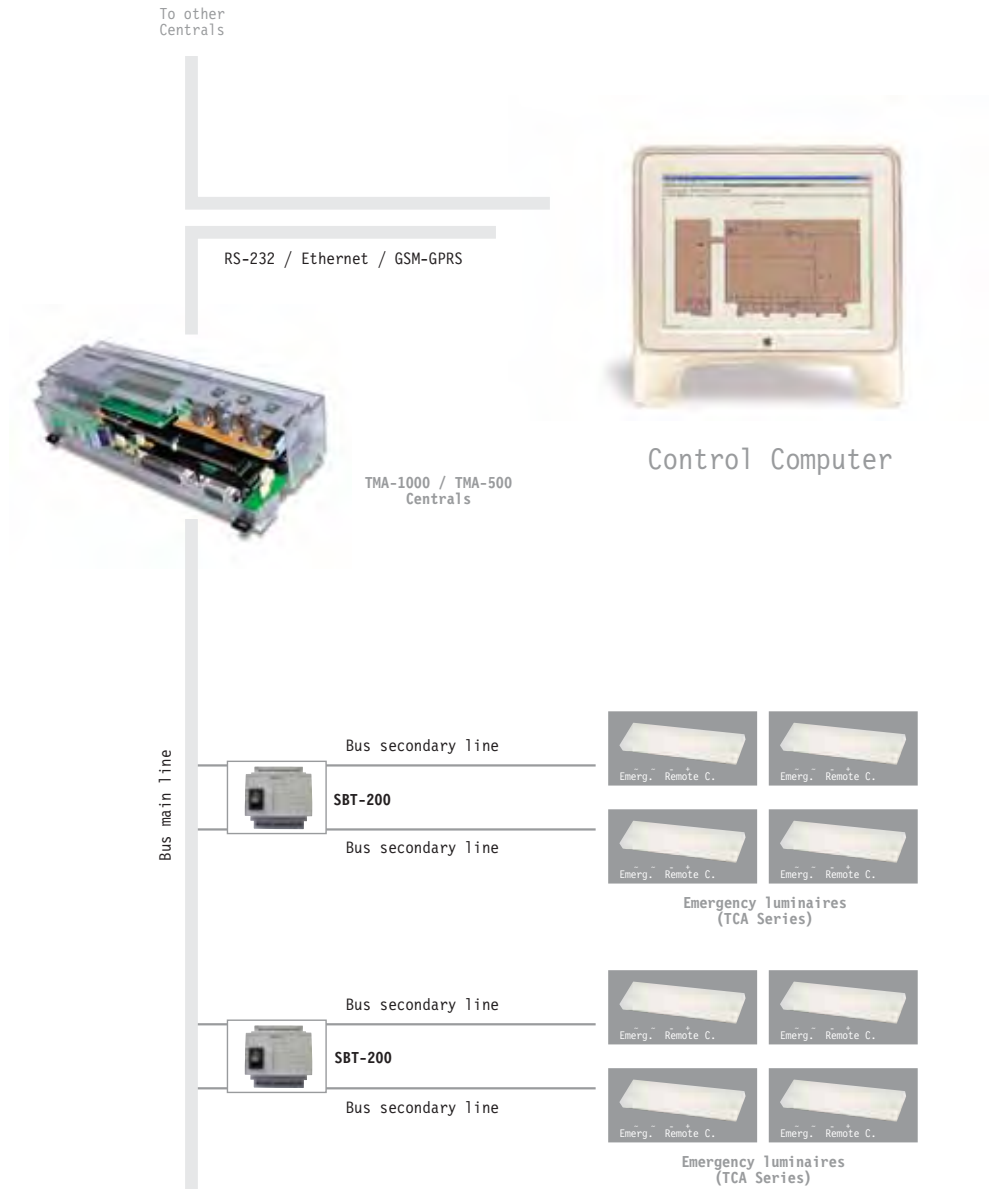

Why has Daisalux developed the DaisaTest System?: All systems in which the number of emergency luminaires reaches a certain volume require very laborious, expensive and awkward maintenance. Proper maintenance EN 50172, EN 62034 (IEC 62034) involves performing both functional and autonomy tests of all the units involved in the system on a routine basis. These tests have to be performed with a minimum frequency and without jeopardizing the proper working of the emergency lighting. In addition, these tests should be suitably recorded. The greater the extent to which the status of an emergency lighting system can be monitored, the more reliable it will be.

The three basic elements of the DaisaTest System

- The TCA series emergency luminaires are capable of running functional and autonomy tests and of communicating with a Central TMA. This TCA Series extends to all Daisalux equipment models and emergency luminaires.
- The Central TMA-1000, TMA-500 are the technological centre of the DaisaTest System. It communicates over two wires (Bus-Tam) with emergency luminaires and equipment to instruct them to run the tests and collect the results. Via a standard RS232 connection it informs the control computer of these results and receives the user's instructions.
- DaisaTest Software is responsible for enabling graphic viewing of the status of the emergency system by means of a computer monitor. For this purpose it may communicate with one or more Central TMA-1000, TMA-500.

Central TMA-1000, TMA-500 the technological centre of the DaisaTest System



Centrals TMA-1000, TMA-500

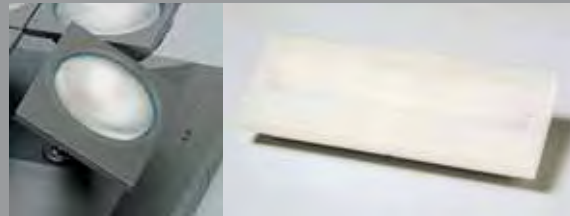

In addition, on each TCA emergency luminaire, 2 LEDs indicate its status, which visually displays the one that has a fault, thus enabling its repair.

DaisaTest System Software

The system is controlled from a compatible computer (PC) on which the DaisaTest program is executed. This program makes it possible to display the status of an emergency lighting system. The installation may include centrals that are capable of testing up to 1000 emergency blocks. We can therefore monitor an indefinite number of luminaires.

The DaisaTest System enables you to use the plans of an emergency installation designed with the Daisa emergency lighting calculation program. In this way, the information is much more graphic and by just glancing at the computer screen we can see which luminaire has a failure, in which part of the installation it is located and what the failure it is.

Daisa program screens (a program developed by Daisalux for producing emergency lighting projects and their photometric calculation).

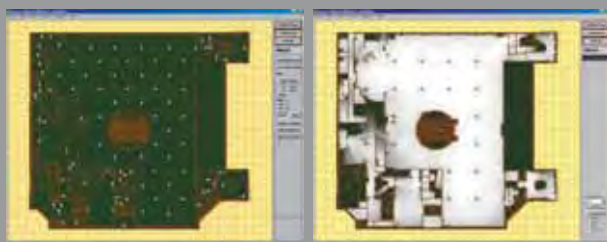

DaisaTest programs screens, after linking with the Daisa program. An established colour code determines the status of each unit at a glance.



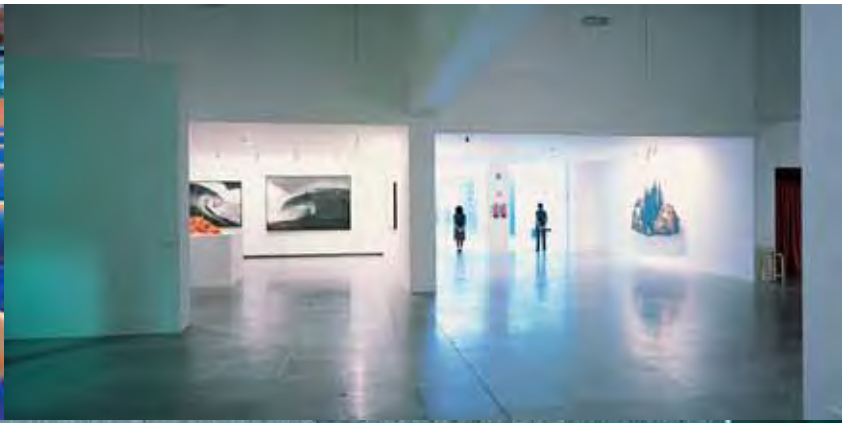

Functions of the DaisaTest System

The main function of the DaisaTest System is to provide an emergency lighting system with reliability and economic maintenance. For this purpose the DaisaTest System will have to check that all the luminaires work properly and inform on the status of the installation. This information is obtained through the computer screen, printed reports and the unit LEDs.

It performs the following checks:

- Keeps a permanent check that the luminaires are connected to the mains, that communication is correct (between luminaires, central and computer), that the battery receives charge and that the charging circuit is not open.
- Performs a functional test every 14 days, a period configurable from 3 to 30 days, which checks emergency lamp switch-on.
- Performs an autonomy test every 6 months, a period configurable from 3 to 12 months, or after re-establishment of an autonomy failure.

Besides the automatic control and test functions, it enables:

- A functional test to be run on a luminaire or entire installation when so wished.
- A printed report to be obtained on the status of the installation or a failure report.
- New units to be decommissioned or installed in an installation.
- The functions of a conventional remote control for switching emergency lights off or back on in case of a power failure, thereby preventing the batteries from being run down.
- Areas to be assigned in the installation (zoning). From the control post (from the computer), you may define as many areas as you like in order to facilitate the location of each luminaire and so that the autonomy tests may be performed progressively in each area. In this way, only one unit will run the autonomy test in the same area, so that the other luminaires remain available in case of a power failure.
- The reliability level to be calculated on each floor and in the installation as a whole. It transmits a warning when it exceeds certain pre-set levels. In this way, it enables maintenance tasks to be regulated.

The DaisaTest System is especially indicated for major retail outlets, shopping centres, museums, etc... and all buildings requiring a particularly safe and reliable emergency lighting system on account of their high occupancy or large number of luminaires.

Daisa program Version 4.0

1. Importing plans / layer management

- Enables projects with multiple plans to be carried out*.
- Allows import of DXF files so the user does not have to draw the plans.
- The Daisa program Versión 4.0 supports importing DXF files so that the user does not need to draw the plans.
- It recognises the layers and their features in the DXF file.
- It allows the relevant layers for calculation to be changed to obstacles.
- Allows the DXF layers to be viewed as a screen, assisting the user to position the evacuation routes, the luminaires, etc. or any of the DXF information*.



2. Evacuation routes / Creating safety points

- The evacuation routes can be defined.
- After performing the calculation, the lighting obtained in each route can be viewed by selecting it.
- All the defined routes are included in the printed report.
- It allows the user to declare safety points and test points, assigning them their operating height and viewing their results.

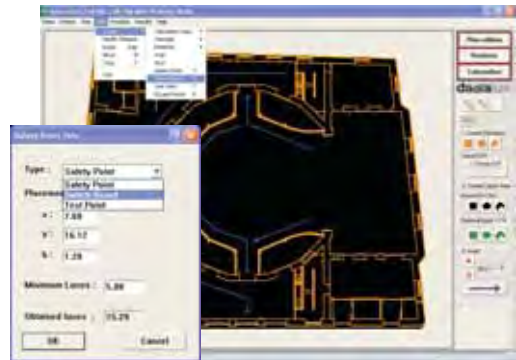

3. Setting targets

- It is possible to set targets to be met by an installation, allocating minimum values for: lux in the plan, evacuation route lux, uniformity of the plan, uniformity of the route, etc.
- It allows a maintenance factor to be defined for the project or plan.
- It is possible to define a 2nd calculation height to obtain the results as a volume.
- It is possible to set default targets or to replace these targets or increase them with others.
- The targets set for the plans and projects can be stored, assigning them a name. In this way, it is possible to store the particular or regulatory demands for their subsequent use.



4. Selecting luminaires and opening the catalogue

- Daisa interacts with the Daisalux catalogue to enable the selection of references, accessories (sealed boxes, recessed housing boxes, flush mounting boxes, signs, etc.).*
- As well as the emergency lights, it is possible to include beacons, signalling luminaires, etc. in the central projects*
- It reports the full budget or budget breakdown for the project.
- Daisa program Versión 4.0 interacts with the Daisalux catalogue to enable the selection of references, accessories, signs, etc.
- It is easy, using a visual interface, to place a reference in its basic position (ceiling or wall).
- If the user wants any other position, the program allows all the coordinates that describe the location of the luminaire in the plan to be changed.



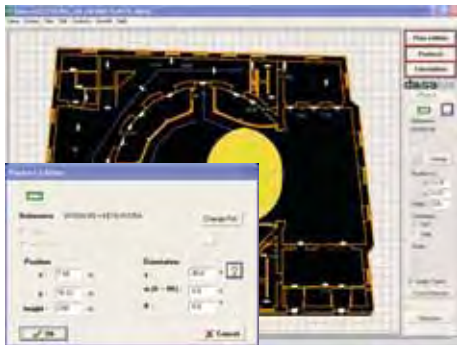

5. Installing luminaires

- It is possible to select one or several luminaires.
- It is possible to replace the references of the selected luminaires, as well as their height and location in the plan*.
- It is possible to replace the references of the selected luminaires.
- Once the luminaire is selected, both its reference and its location are shown on the right-hand side of the screen.
- When a luminaire is to be positioned or a positioned luminaire is selected, its coverage can be viewed*.
- Graphically, the luminaires with a sign are distinguished from those without a sign.
- Other actions that can be performed with the luminaires include moving, deleting, copying, changing position, adding sign, etc.

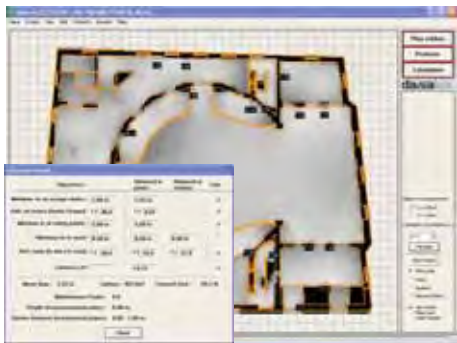

6. Calculation

- The calculation can be configured by setting the resolution and the Isolux curves to be calculated.
- Daisa program Version 4.0 makes it possible to configure the calculation by setting the resolution and the Isolux curves to be calculated.
- While the calculation is being made, a progress bar appears at the bottom of the window.
- The calculation can be cancelled at any time.
- The Daisa program Version 4.0 provides and displays various results for each height of the calculation in different sections, rasters, isolux curves, evacuation routes, safety points for manual and test use.
- Daisa program Version 4.0 shows the results obtained, comparing them with the objectives required by the user and reports on any that have not been fulfilled.
- Show the results for each height calculation in the sections: rasters, Isolux curves, evacuation routes, safety points and electrical boxes.
- It shows the obtained results, comparing them with the objectives required by the user and reports on any that are not fulfilled.

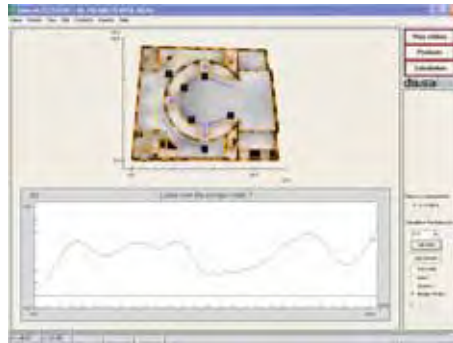
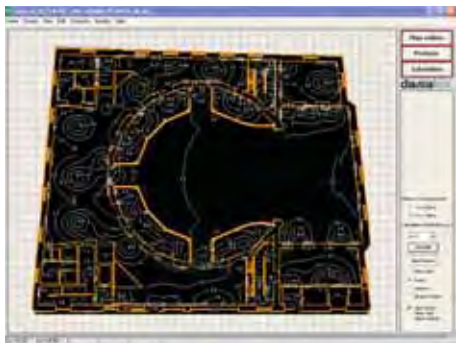

7. Project Report

It generates a complete regulation-oriented report with the following sections:

- List of Project Plans.
- Plan with the location of the luminaires.
- List of luminaires used in the plan.
- Anti-panic results:
 - Graphic of rasters in the plan.
 - Isolux curves of the plan.
 - Volumetric result.
- Evacuation results:
 - Evacuation routes.
 - Manual use safety points.
 - Testing points.
- Technical specifications.
- Project estimate.
- The report may also be generated in an editable document (RTF format)*.

8. Exporting results

- It allows the results to be exported (Isolux curves, safety points, electrical boxes, evacuation routes and position of products) to files with DXF format, thus allowing this information to be imported to the original plan files.
- The project's budget may also be exported to FIEBDC and text formats, as well as to an editable document (RTF format).

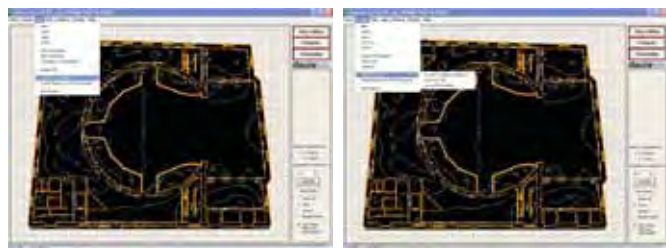

In order to guarantee the successful implementation of your projects, Daisalux places at your disposal a department where we offer the following, free of charge: a) consulting regarding the operation of the program, b) implementation of your complete project if required. **Projects Department:** Phone: 0034 945 290 181 / e-mail: export@daisalux.com / The Daisa program Version 4.0 is available free of charge at www.daisalux.com

Daisalux and the environment

Daisalux has developed its environmental policy under the Eco-design perspective. The objective is to minimize the environmental impact in the life cycles of the product searching developments which integrate ecologic designs.

This implies the implementation of a methodology that involves all departments and areas of the company, in order to be able to offer more quality products. For that matter Daisalux introduce the following improvements:

- Environmental improvements: we have searched a non-contaminant alternative to the Ni-Cd (nickel cadmium) batteries, through the adoption of a NI-MH (nickel metal hydride) and the necessary changes in the circuit for its application, which besides provide us with other results such as: the reduction in the power consumption of the units by 50%, the use of recycled plastic in interior components and the use of an ecologic printed circuit.
- Cost reduction for the end user due to the lower unit consumption.
- More and more complete information for the end user about the final life cycle of the product. Additional information on the Eco-design and the results of the project is available in our Website.
- The products of Daisalux are in compliance with the WEE (Waste Electric and Electronic Equipment) 2002/96/EC European Directive that regulates the end life and design of electrical and electronic products, and they are also in compliance with the 2002/95/EC **RoHS** directive on the restriction of the use of certain hazardous substances in electrical and electronic equipment.

With the implementation of this Eco-design methodology, Daisalux commits to the prevention of pollution and to help preserving the environment.

When referring to environment, less means more, less residues and more benefit for all.

General Catalogue

Nova Series

Construction details: Built to EN 60598-2-22 (IEC 60598-2-22) standard / Conforming to Community Electromagnetic Compatibility, Low Voltage and **RoHS** Directives 2004/108/EC, 2006/95/EC and 2002/95/EC / Built to synthetic materials, 850°C to EN 60598-1 (IEC 60598-1) and EN 60695-2-1 (IEC 60695-2-1), according to models / Battery protected against excessive discharges and polarity reversal / Stand-by setting by remote control / Remote control circuit protected against connection errors / Testing by remote control when mains voltage is present / Electric shock protection: Class II / Luminaire suitable for mounting on normally inflammable surfaces: Class "F" / **IP 44 IK 04** / 100% functional testing of production with computer-electronic systems.







Surface Nova

Base, reflector and diffuser made of polycarbonate.
Colours: white as standard, black optional.



NOVA

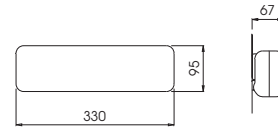

Recessed Nova

With ABS recessing accessory. Colours: white or black.



NOVA + KEB NOVA

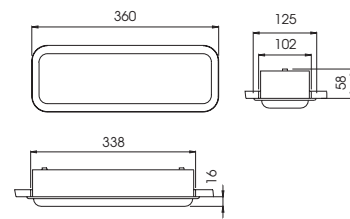

Hole required: 338 mm. x 102 mm.

Biplane Nova

Blended or opal diffuser, made of polycarbonate.



NOVA + KBO NOVA

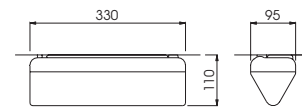

Recessed Biplane Nova

With ABS recessing box.



NOVA + KBO NOVA + KEB NOVA

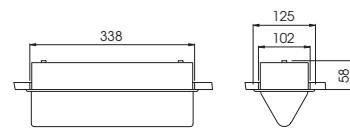

Hole required: 338 mm. x 102 mm.

Sealed Nova

Box made of polycarbonate with three M20 inputs, stainless steel nuts and bolts, protection class IP 66 IK 08.



NOVA + KES NOVA

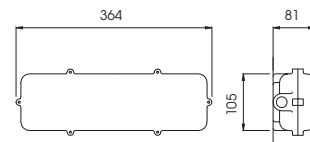

Nova Series

It represented a revolution in emergency lighting; a single luminaire provided with a variety of accessories capable of achieving different applications (Recessed Nova, Surface Nova, Recessed Biplane Nova, Surface Biplane Nova, Sealed Nova), as if it were a case of different emergency luminaires. A Daisalux classic, which continues to blend into the latest architectural environments on account of its low cost, its functional capability and its timeless character.

Model	Autonomy	Lumens	Emerg. lamp	Charging monitor
Non maintained:				
NOVA N1	1 h	70	FL 6 W	White LED
NOVA N2	1 h	95	FL 8 W	White LED
NOVA N3	1 h	150	FL 8 W	White LED
NOVA N5	1 h	215	FL 8 W	White LED
NOVA N6	1 h	320	FL 8 W	White LED
NOVA N8	1 h	435	FL 8 W	White LED
NOVA N11	1 h	570	PL 11 W	White LED
NOVA 2N3	2 h	100	FL 8 W	White LED
NOVA 2N7	2 h	255	FL 8 W	White LED
NOVA 3N4	3 h	210	FL 8 W	White LED
Nova cold stores				
NOVA N2 FR20 (1)	1 h	74	FL 8 W	from -20° to 0°
NOVA N2 FR40 (1)	1 h	74	FL 8 W	from -40° to -20°

Model	Autonomy	Lumens	Emerg. lamp	Mains lamp	Charging monitor
Combined (2)					
NOVA C3	1 h	145	FL 8 W	FL 8 W	White LED
NOVA C6	1 h	300	FL 8 W	FL 8 W	White LED
NOVA C8	1 h	420	FL 8 W	FL 8 W	White LED
NOVA 2C5	2 h	255	FL 8 W	FL 8 W	White LED
NOVA 3C4	3 h	200	FL 8 W	FL 8 W	White LED

Nova A Series Specific for Self-test

Includes microprocessor for operation in Self-test mode.

Model	Autonomy	Lumens	Emerg. lamp	Charging monitor
Non maintained:				
NOVA N2 A	1 h	90	FL 8 W	White LED
NOVA N3 A	1 h	160	FL 8 W	White LED
NOVA N5 A	1 h	205	FL 8 W	White LED
NOVA N6 A	1 h	315	FL 8 W	White LED
NOVA N8 A	1 h	400	FL 8 W	White LED
NOVA N10 A	1 h	485	PL 11 W	White LED
NOVA 2N3 A	2 h	140	FL 8 W	White LED
NOVA 2N5 A	2 h	205	FL 8 W	White LED
NOVA 3N3 A	3 h	160	FL 8 W	White LED

Combined Self-test (2)

Combined Self-test models can be supplied on request. Check with the factory.

Nova TCA Series Specific for Self-test and DaisaTest System

Includes microprocessor for operating in Self-test mode and DaisaTest centralised management System. TCA models can be supplied on request. **Check with the factory or our web site: www.daisalux.com**
TMA Test Central for Nova TCA. See page 16.

Finishes

Finish of:	Description	Marking
Colour	White (standard)	----
	Black	(BLACK)

Accessories

Reference:	Description	Resultant flux
KBO NOVA	Opal biplane diffuser	96%
KBT NOVA	Transparent biplane diffuser	107%
KEB NOVA	White recessed housing box (3)	88%
KEN NOVA	Black recessed housing box (3)	88%
KES NOVA	Sealed box IP 66 IK 08	105%
RT..	Exit signs (stickers) (See next page)	75%

Example of order:

Order for 30 emergency luminaires NOVA N11, non maintained, recessed with opal biplane diffuser:

30 NOVA N11
30 KEB NOVA
30 KBO NOVA

Operation, Common Data and Notes

- (1) Includes sealed box with **IP 66 IK 08** protection class.
- (2) Combined models have two tubes, one of which can be switched on and off with mains voltage present, while the other comes into operation in the event of a power failure. Appliances not suitable for recessing in walls or ceilings unless it is possible to guarantee that the air inside them will be refreshed.
- (3) Recessed housing box (KE... NOVA): Suitable for installation in walls and ceilings made from plaster board, wood, plywood, plaster, etc.

Emergency signs

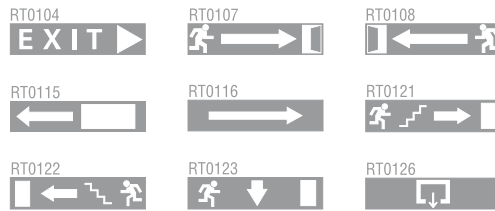

DIMENSIONS: 300 x 70 mm 

NOTE: Customized signs and pictograms may be supplied to order.

Photometric curves

Combined Nova

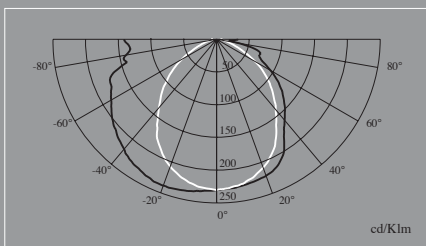

Nova FL

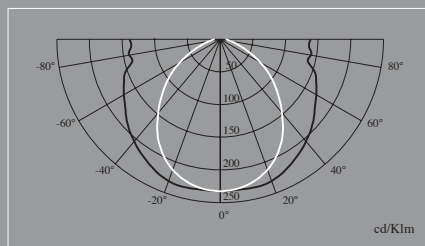

Nova PL

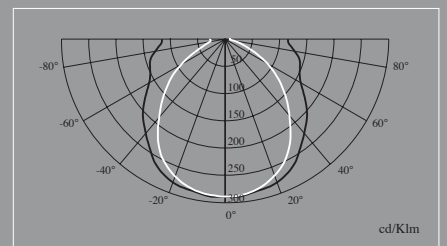

— Horizontal cut-off — Vertical cut-off



Single Argos Series

Construction details: Built to EN 60598-2-22 (IEC 60598-2-22) standard / Conforming to Community Electromagnetic Compatibility, Low Voltage and **RoHS** Directives 2004/108/EC, 2006/95/EC and 2002/95/EC / Built to synthetic materials, 850°C to EN 60598-1 (IEC 60598-1) and EN 60695-2-1 (IEC 60695-2-1), according to models / Battery protected against excessive discharges and polarity reversal / Setting on stand-by by remote control / Testing by remote control when mains voltage is present / Protection against electric shocks: Class II / Luminaire suitable for fitting on normally inflammable surfaces: Class "F" / **IP 32 IK 04** / 100% functional testing of production with computer-electronic systems / Mains input thermal protector.



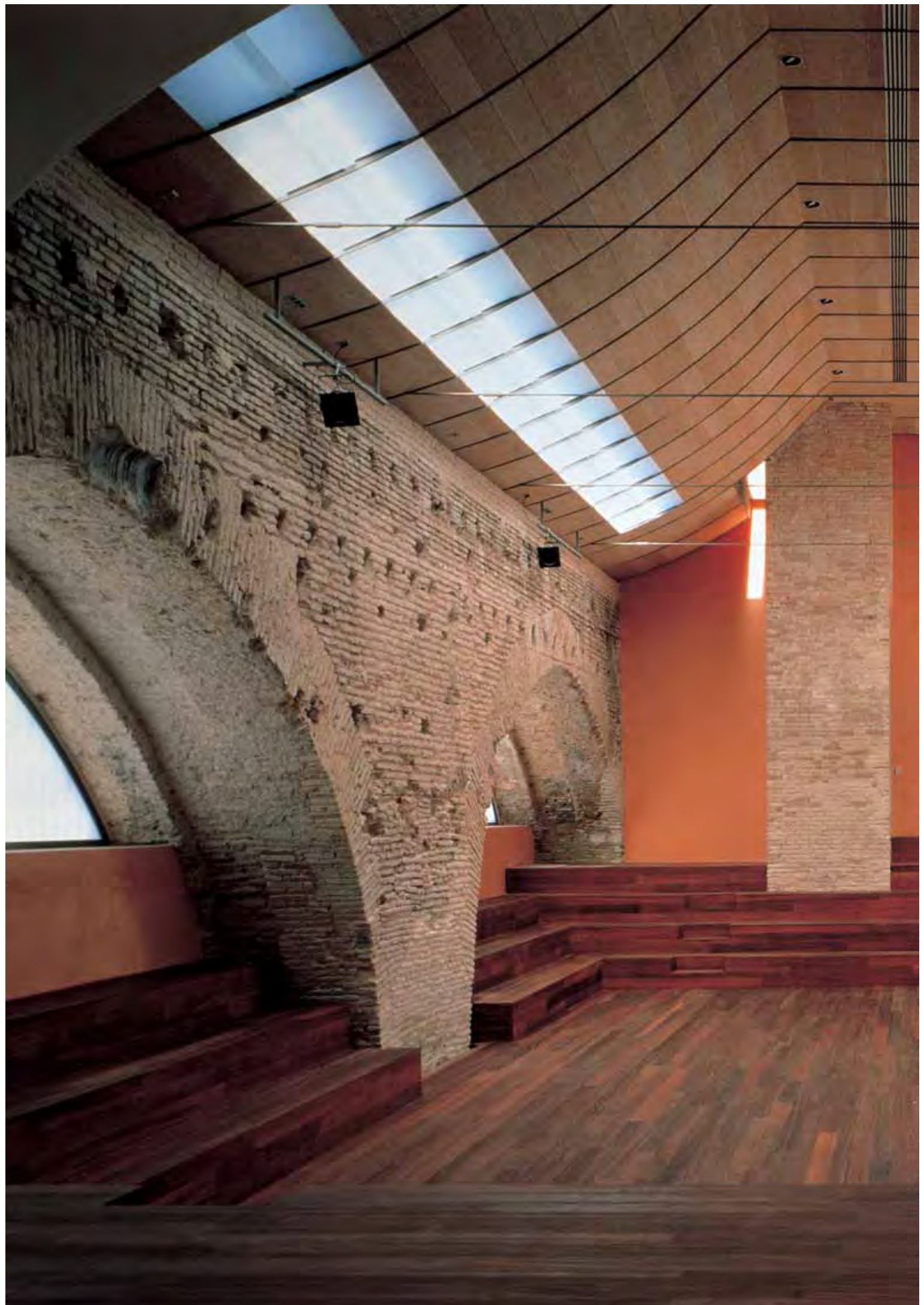

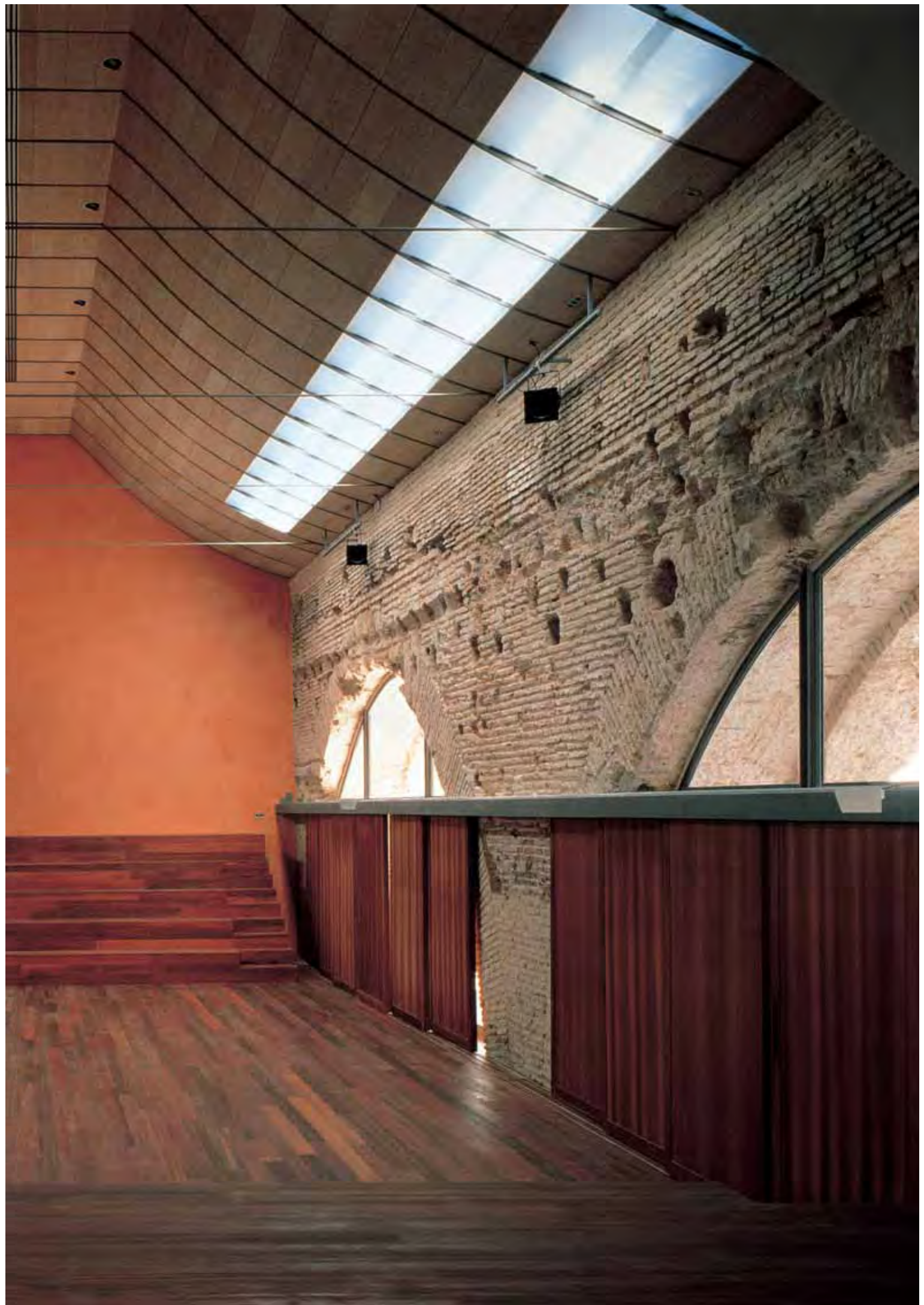

Surface Single Argos

Housing made of PC-ASA.
 Colours: white (standard),
 metallic dark grey and silver
 grey optional. Opal
 polycarbonate diffuser.



ARGOS (GREY)

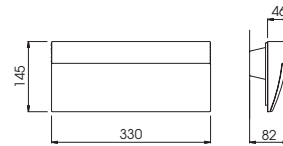

Semi-recessed Single Argos

With semi-recessing
 accessory.

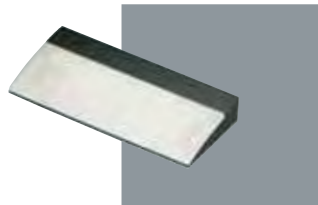

ARGOS (GREY)
 + KS ARGOS

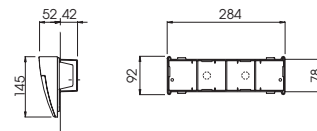

Single Argos Series

Enhances with its finishes and forms. Its apparently representative nature only serves to reinforce the basic principle of blending in with the other architectural features.

Model	Autonomy	Lumens	Emerg. lamp	Charging monitor
Non maintained:				
ARGOS N2	1 h	80	FL 8 W	White LED
ARGOS N3	1 h	130	FL 8 W	White LED
ARGOS N6	1 h	285	FL 8 W	White LED
ARGOS N8	1 h	385	FL 8 W	White LED
ARGOS 2N5	2 h	225	FL 8 W	White LED
ARGOS 3N4	3 h	185	FL 8 W	White LED

Model	Autonomy	Lumens	Emerg. lamp	Mains lamp	Charging monitor
Combined (1)					
ARGOS C3	1 h	125	FL 8 W	FL 8 W	White LED
ARGOS C6	1 h	265	FL 8 W	FL 8 W	White LED
ARGOS C8	1 h	370	FL 8 W	FL 8 W	White LED
ARGOS 2C5	2 h	225	FL 8 W	FL 8 W	White LED
ARGOS 3C4	3 h	175	FL 8 W	FL 8 W	White LED

Single Argos A Series Specific for Self-test

Includes microprocessor for operation in Self-test mode

Model	Autonomy	Lumens	Emerg. lamp	Charging monitor
Non maintained:				
ARGOS N2 A	1 h	80	FL 8 W	White LED
ARGOS N3 A	1 h	135	FL 8 W	White LED
ARGOS N6 A	1 h	260	FL 8 W	White LED
ARGOS N8 A	1 h	340	FL 8 W	White LED
ARGOS 2N5 A	2 h	180	FL 8 W	White LED
ARGOS 3N4 A	3 h	140	FL 8 W	White LED

Combined Self-test (1)

Combined Self-test models can be supplied on request. Check with the factory.

Single Argos TCA Series Specific for Self-test and DaisaTest System

Includes microprocessor for operating in Self-test mode and DaisaTest centralised management System.

TCA models can be supplied on request. **Check with the factory or our web site: www.daisalux.com**

TMA Test Central for SINGLE ARGOS TCA. See page 16.

Finishes

Finish of:	Description	Marking
Colour	White (standard)	(RAL9003)
	Metallic dark grey	(GREY)
	Silver grey	(RAL9006)

Accessories

Reference:	Description	Resultant flux
KS ARGOS	Semi-recessed housing box (2)	100%
RT...	Exit signs (stickers) (refer to next page)	70%

Example of order:

Order for 20 emergency luminaires ARGOS N3, non maintained, semi-recessed in metallic dark grey colour:

20 ARGOS N3 (GREY)
20 KS ARGOS

Operation, Common Data and Notes

- (1) Combined models have two tubes, one of which can be switched on and off with mains voltage present, while the other comes into operation in the event of power failure.
- (2) Semi-recessed housing box (KS... ARGOS): Suitable for installation in ceilings and walls made from breezeblock, brick, stone, etc.

Emergency signs

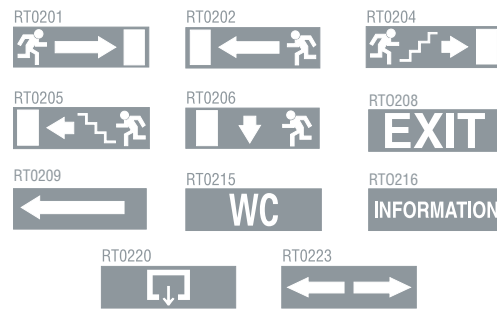

DIMENSIONS: 311 x 95 mm 

NOTE: Customized exit signs and pictograms may be supplied to order.

Photometric curves

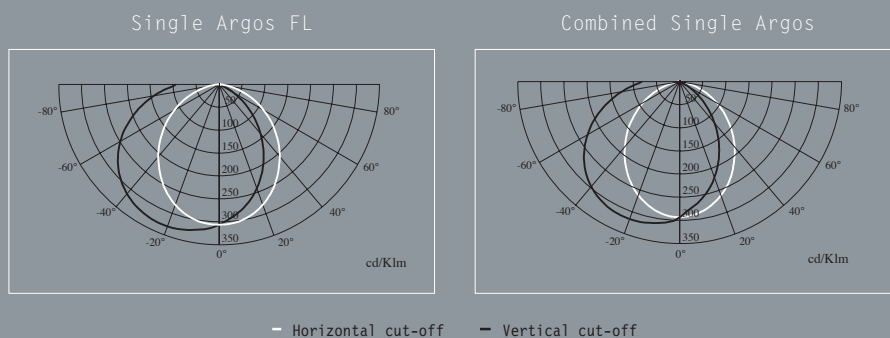

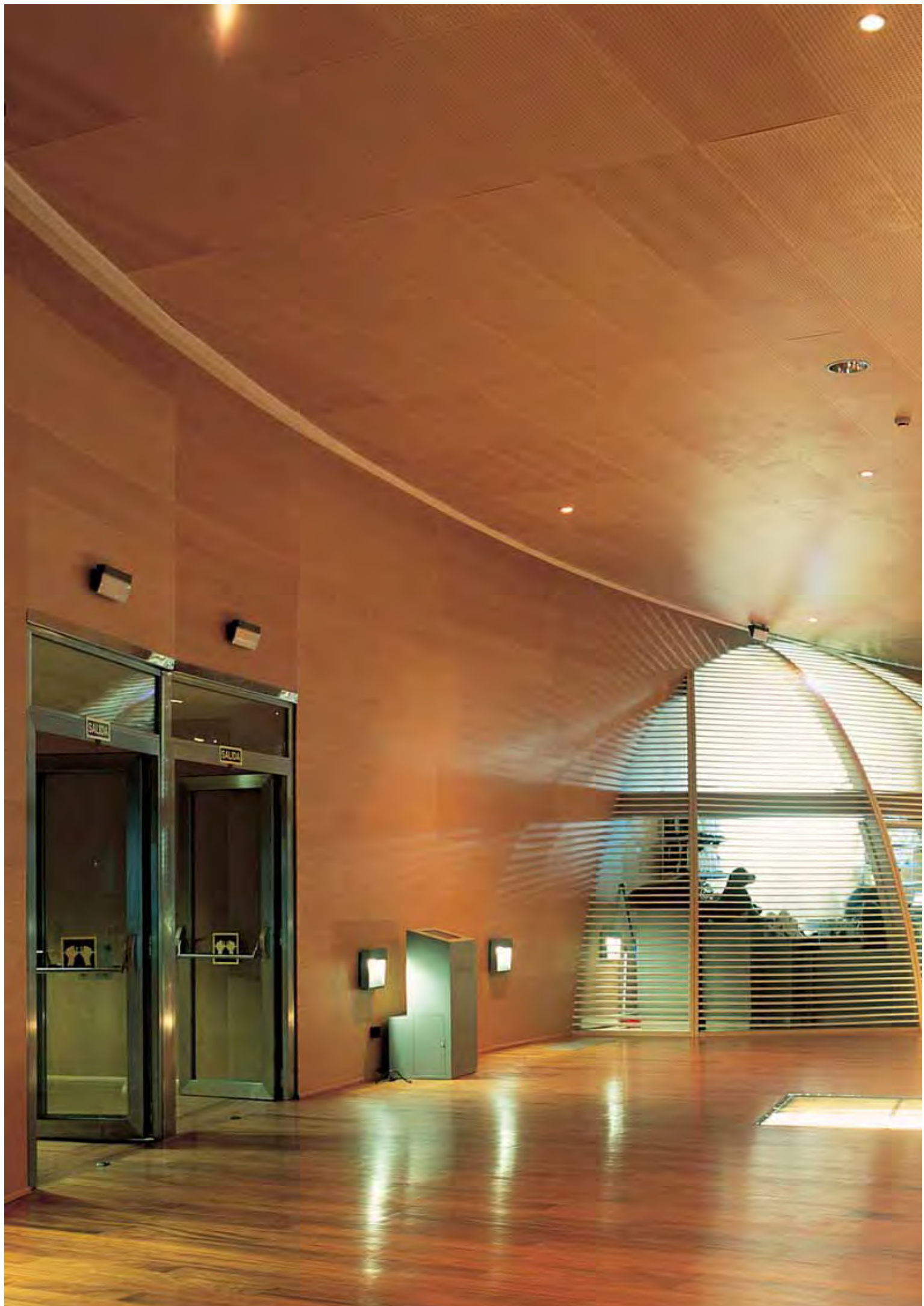

Double Argos Series

Construction details: Built to EN 60598-2-22 (IEC 60598-2-22) standard / Conforming to Community Electromagnetic Compatibility, Low Voltage and **RoHS** Directives 2004/108/EC, 2006/95/EC and 2002/95/EC / Built to synthetic materials, 850°C to EN 60598-1 (IEC 60598-1) and EN 60695-2-1 (IEC 60695-2-1), according to models / Battery protected against excessive discharges and polarity reversal / Setting on stand-by by remote control / Testing by remote control when mains voltage is present / Protection against electric shocks: Class II / Luminaire suitable for fitting on normally inflammable surfaces: Class "F" / **IP 42 IK 04** / Mains input thermal protector / 100% functional testing of production with computer-electronic systems.







Attached Double Argos
 Polycarbonate connection
 bracket, chromed ABS
 rosette.



ARGOS-D (GREY)
 + KTA ARGOS

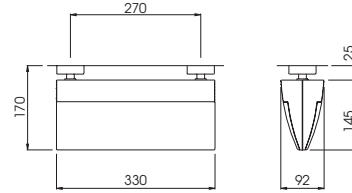

Pennant Double Argos
 Metal flag bracket,
 painted white, metallic
 dark grey or silver grey,
 electrolysed, in gold and
 chrome finishes. Chromed
 and polished metal
 connecting caps.



ARGOS-D (GREY)
 + KBG ARGOS

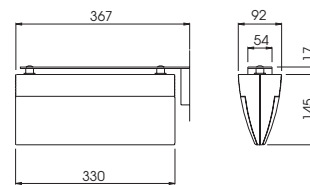

Suspended Double Argos
 Chromed and polished
 metal tube. Polycarbonate
 connection bracket,
 chromed ABS rosette.



ARGOS-D (GREY)
 + KS30 ARGOS or
 ARGOS-D (GREY)
 + KS100 ARGOS

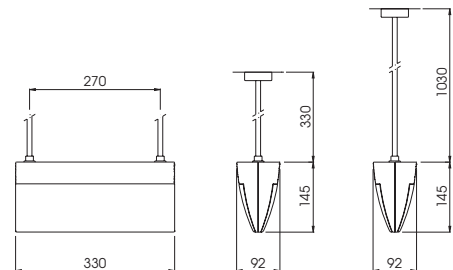

Double Argos Series

Enhances with its finishes and forms. Its apparently representative nature only serves to reinforce that basic principle of blending in with the other architectural features.

Model	Autonomy	Lumens	Emerg. lamp	Charging monitor
Non maintained:				
ARGOS-D N3	1 h	160	FL 8 W	White LED
ARGOS-D N6	1 h	320	FL 8 W	White LED
ARGOS-D N8	1 h	400	FL 8 W	White LED
ARGOS-D 2N6	2 h	280	FL 8 W	White LED
ARGOS-D 3N4	3 h	210	FL 8 W	White LED

Model	Autonomy	Lumens	Emerg. lamp	Mains lamp	Charging monitor
Combined (1)					
ARGOS-D C3	1 h	150	FL 8 W	FL 8 W	White LED
ARGOS-D C6	1 h	300	FL 8 W	FL 8 W	White LED
ARGOS-D C8	1 h	400	FL 8 W	FL 8 W	White LED
ARGOS-D 2C6	2 h	270	FL 8 W	FL 8 W	White LED
ARGOS-D 3C4	3 h	200	FL 8 W	FL 8 W	White LED

Double Argos A Series Specific for Self-test

Includes microprocessor for operation in Self-test mode.

Model	Autonomy	Lumens	Emerg. lamp	Charging monitor
Non maintained:				
ARGOS-D N3 A	1 h	180	FL 8 W	White LED
ARGOS-D N6 A	1 h	340	FL 8 W	White LED
ARGOS-D N8 A	1 h	450	FL 8 W	White LED
ARGOS-D 2N6 A	2 h	270	FL 8 W	White LED
ARGOS-D 3N4 A	3 h	170	FL 8 W	White LED

Combined Self-test (1)

Combined Self-test models can be supplied on request. Check with the factory.

Double Argos TCA Series Specific for Self-test and DaisaTest System

Includes microprocessor for operating in Self-test mode and DaisaTest centralised management System.

TCA models can be supplied on request. **Check with the factory or our web site: www.daisalux.com**

TMA Test Central for DOUBLE ARGOS TCA. See page 16.

Finishes

Finish of:	Description	Marking
Colour	White (standard)	(RAL9003)
	Metallic dark grey	(GREY)
	Silver grey	(RAL9006)

Accessories

Reference:	Description	Resultant flux
KBG ARGOS	Grey pennant mounting kit	100%
KBGP ARGOS	Silver grey pennant mounting kit	100%
KBB ARGOS	White pennant mounting kit	100%
KBO ARGOS	Gold pennant mounting kit	100%
KBC ARGOS	Chrome pennant mounting kit	100%
KS30 ARGOS	Suspended at 30 cm. mounting kit	100%
KS100 ARGOS	Suspended at 100 cm. mounting kit	100%
KTA ARGOS	Attached mounting kit	100%
RT...	Exit signs (stickers)	65%
	(refer to next page)	

Example of order:

Order for 15 emergency luminaires ARGOS-D N8, non maintained in silver grey colour and suspended at 30 cms.:

15 ARGOS-D N8 (RAL9006)
15 KS30 ARGOS

Operation, Common Data and Notes

(1) Combined models have two tubes, one of which can be switched on and off with mains voltage present, while the other comes into operation in the event of a power failure.

ALL DOUBLE ARGOS MODELS NEED A MOUNTING KIT, REF.: K... (SEE ACCESSORIES).

Emergency signs

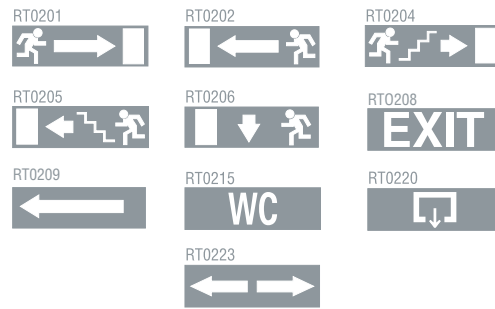

DIMENSIONS: 311 x 95 mm 

NB: Customized exit signs and pictograms may be supplied to order.

Photometric curves

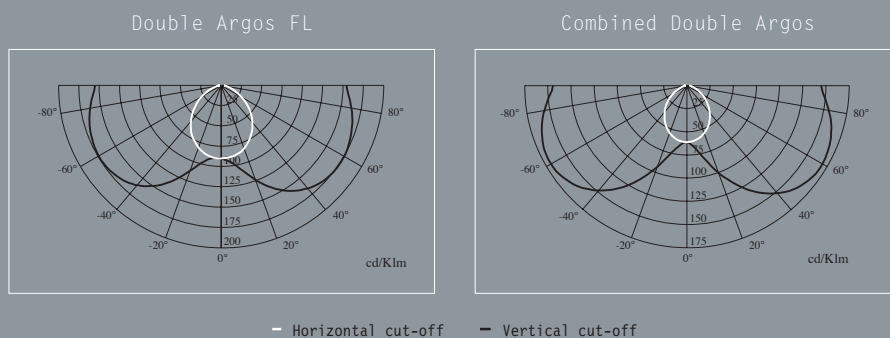



Built-in Argos Series

Construction details: Built to EN 60598-2-22 (IEC 60598-2-22) standard / Conforming to Community Electromagnetic Compatibility, Low Voltage and **RoHS** Directives 2004/108/EC, 2006/95/EC and 2002/95/EC / Built to synthetic materials, 850°C to EN 60598-1 (IEC 60598-1) and EN 60695-2-1 (IEC 60695-2-1), according to models / Battery protected against excessive discharges and polarity reversal / Setting on standby by remote control / Remote control circuit protected against connection errors / Testing by remote control when mains voltage is present / Protection against electric shocks: Class II / Luminaire suitable for fitting on normally inflammable surfaces: Class "F" / **IP 44 IK 04** / Mains input thermal protector / 100% functional testing of production with computer-electronic systems.







Built-in Argos
Colours: standard white,
metallic grey and silver
grey optional. Opal
polycarbonate diffuser.

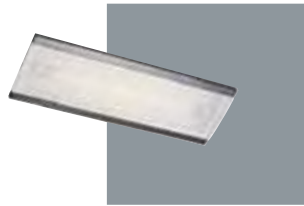

ARGOS-M (GREY)

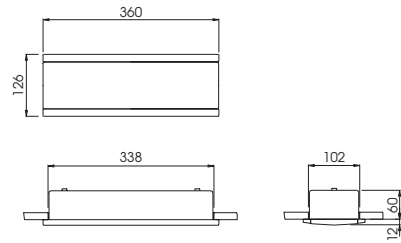

Hole required: 338 mm. x 102 mm.

Built-in Argos Series

Enhances with its finishes and forms. Its apparently representative nature only serves to reinforce that basic principle of blending in with the other architectural features.

Model	Autonomy	Lumens	Emerg. lamp	Charging monitor
Non maintained:				
ARGOS-M N1	1 h	55	FL 6 W	White LED
ARGOS-M N2	1 h	75	FL 8 W	White LED
ARGOS-M N3	1 h	120	FL 8 W	White LED
ARGOS-M N5	1 h	175	FL 8 W	White LED
ARGOS-M N6	1 h	260	FL 8 W	White LED
ARGOS-M N8	1 h	350	FL 8 W	White LED
ARGOS-M N11	1 h	460	PL 11 W	White LED
ARGOS-M 2N3	2 h	80	FL 8 W	White LED
ARGOS-M 2N7	2 h	205	FL 8 W	White LED
ARGOS-M 3N4	3 h	170	FL 8 W	White LED

Model	Autonomy	Lumens	Emerg. lamp	Mains lamp	Charging monitor
Combined (1)					
ARGOS-M C3	1 h	115	FL 8 W	FL 8 W	White LED
ARGOS-M C6	1 h	245	FL 8 W	FL 8 W	White LED
ARGOS-M C8	1 h	340	FL 8 W	FL 8 W	White LED
ARGOS-M 2C5	2 h	205	FL 8 W	FL 8 W	White LED
ARGOS-M 3C4	3 h	160	FL 8 W	FL 8 W	White LED

Built-in Argos A Series Specific for Self-test

Includes microprocessor for operation in Self-test mode.

Model	Autonomy	Lumens	Emerg. lamp	Charging monitor
Non maintained:				
ARGOS-M N2 A	1 h	70	FL 8 W	White LED
ARGOS-M N3 A	1 h	130	FL 8 W	White LED
ARGOS-M N5 A	1 h	165	FL 8 W	White LED
ARGOS-M N6 A	1 h	255	FL 8 W	White LED
ARGOS-M N8 A	1 h	325	FL 8 W	White LED
ARGOS-M N10 A	1 h	390	PL 11 W	White LED
ARGOS-M 2N3 A	2 h	110	FL 8 W	White LED
ARGOS-M 2N5 A	2 h	165	FL 8 W	White LED
ARGOS-M 3N3 A	3 h	130	FL 8 W	White LED

Combined Self-test (1)

Combined Self-test models can be supplied on request. Check with the factory.

Built-in Argos TCA Series Specific for Self-test and DaisaTest System

Includes microprocessor for operating in Self-test mode and DaisaTest centralised management System.

TCA models can be supplied on request. **Check with the factory or our web site: www.daisalux.com**

TMA Test Central for BUILT-IN ARGOS TCA. See page 16.

Finishes

Finish of:	Description	Marking
Colour	White (standard)	(RAL9003)
	Metallic dark grey	(GREY)
	Silver grey	(RAL9006)

Accessories

Reference:	Description	Resultant flux
KEB ARGOS	Built-in white box	100%
KEG ARGOS	Built-in grey box	100%
KEP ARGOS	Built-in silver grey box	100%
RT..	Exit signs (stickers) (See next page)	75%

Example of order:

Order for 50 emergency luminaires ARGOS-M N6, non maintained in white colour:

50 ARGOS-M N6

Operation, Common Data and Notes

(1) Combined models have two tubes, one of which can be switched on and off with mains voltage present, while the other comes into operation in the event of a power failure. Appliances not suitable for recessing in walls or ceilings unless it is possible to guarantee that the air inside them will be refreshed.

Built-in Argos models (ARGOS-M) are composed of an Argos recessing box + NOVA (supplied separately). The Built-In Argos series is suitable for installation in walls and ceilings made from plaster board, wood, plywood, plaster, etc.

Emergency signs

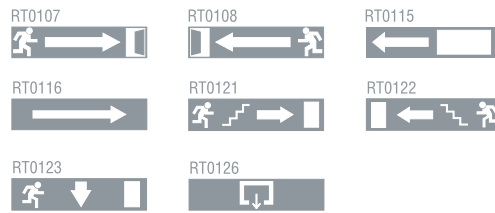

DIMENSIONS: 300 x 70 mm 

NOTE: Customized exit signs and pictograms may be supplied to order.

Photometric curves

FL Built-in Argos

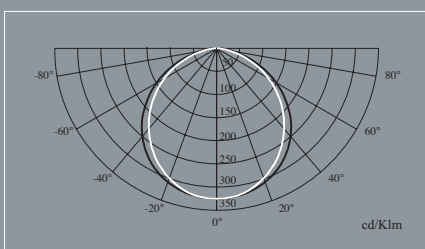

PL Built-in Argos

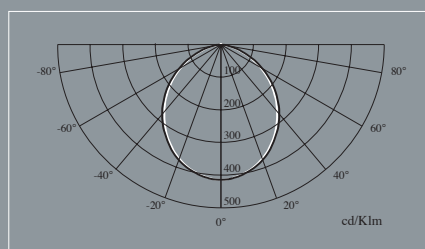

Combined Built-in Argos

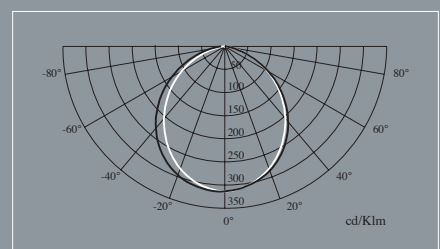

— Horizontal cut-off — Vertical cut-off



Hydra Series

Construction details: Built to EN 60598-2-22 (IEC 60598-2-22) standard / Conforming to Community Electromagnetic Compatibility, Low Voltage and **RoHS** Directives 2004/108/EC, 2006/95/EC and 2002/95/EC / Built to synthetic materials, 850°C to EN 60598-1 (IEC 60598-1) and EN 60695-2-1 (IEC 60695-2-1), according to models / Battery protected against excessive discharges and polarity reversal / Stand-by setting by remote control / Remote control circuit protected against connection errors / Electric shock protection: Class II / Luminaire suitable for mounting on normally inflammable surfaces: Class "F" / **IP 42 IK 04** / Mains input thermal protector / 100% functional testing of production with computer-electronic systems.

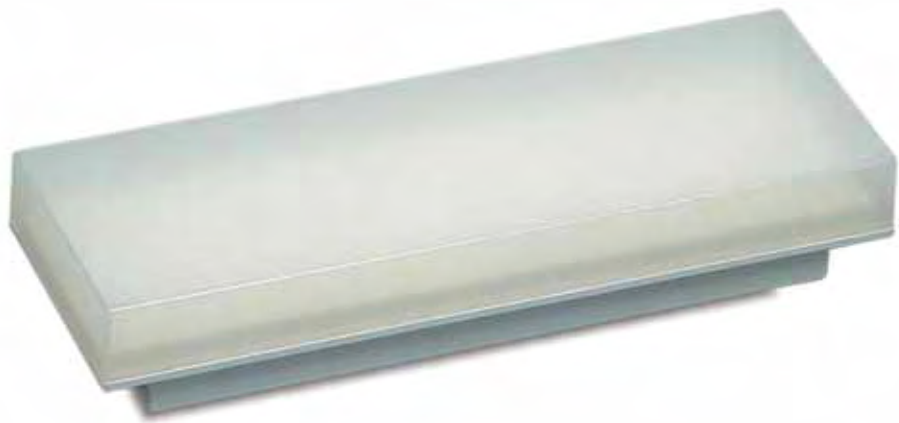

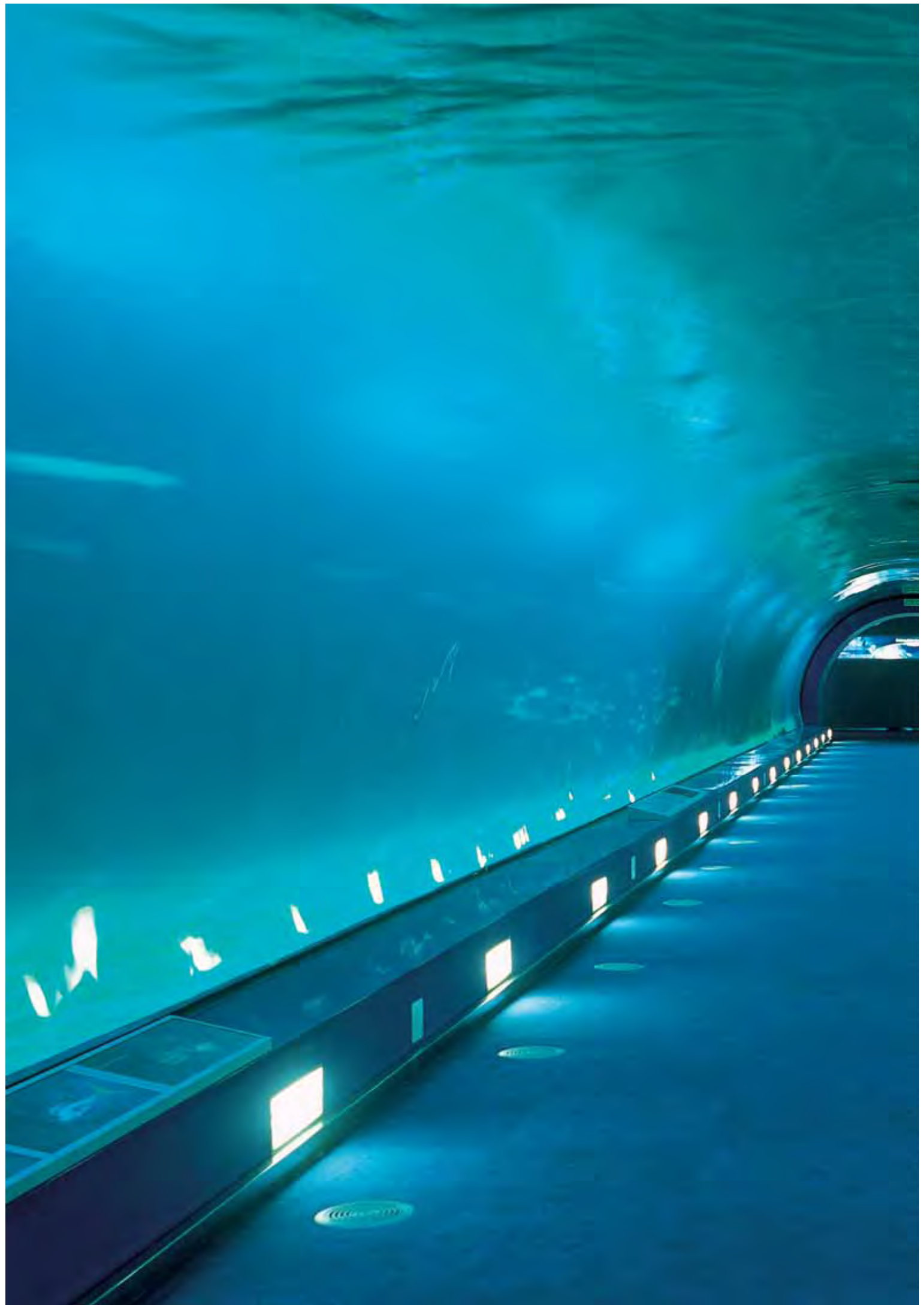

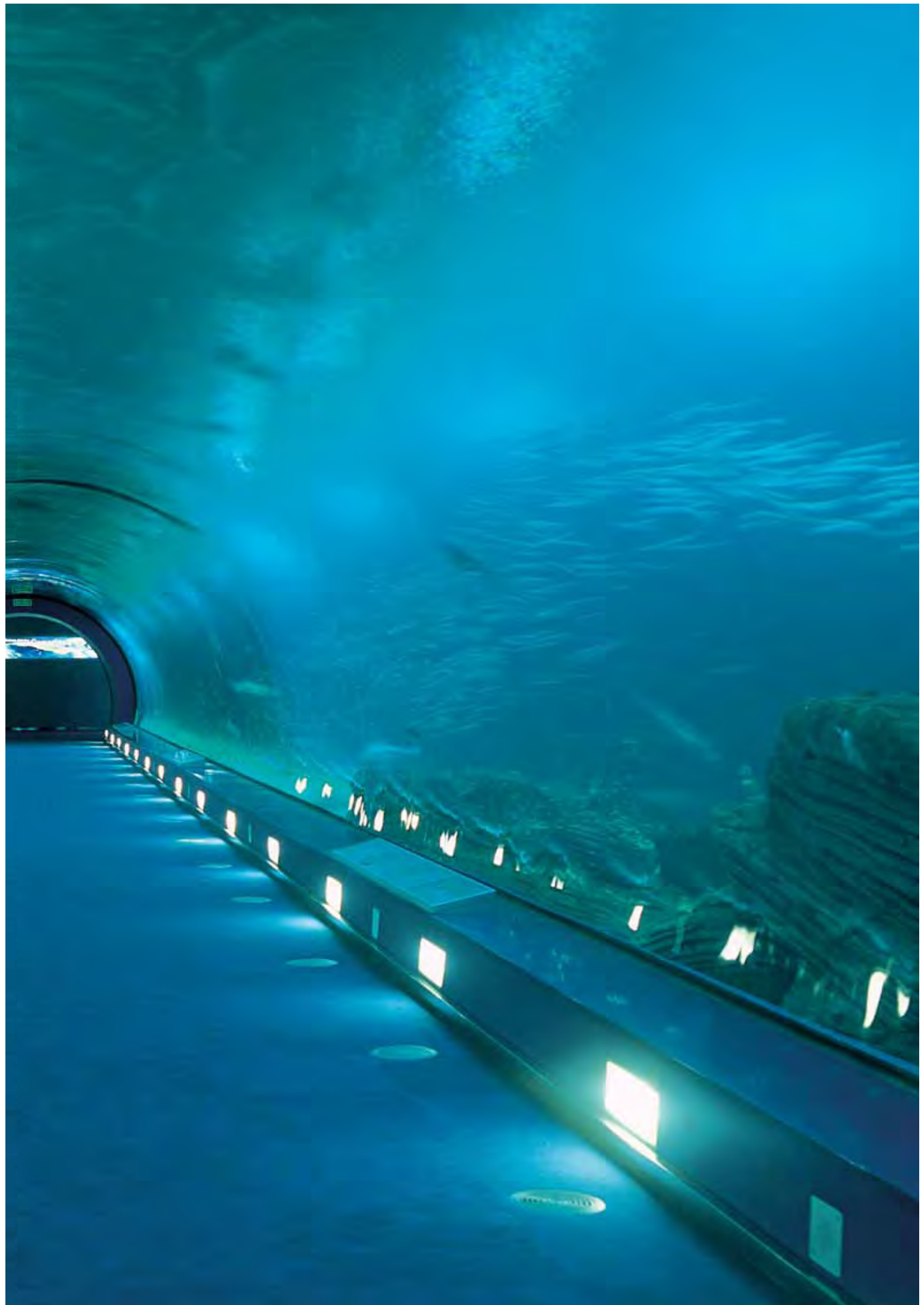

Surface Hydra
 Base and reflector made of white PC, diffuser of transparent, opal or very opal polycarbonate.

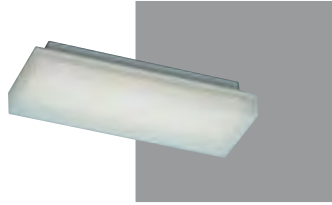

HYDRA

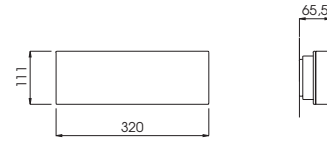

Semi-recessed wall Hydra
 With semi-recessing accessory.

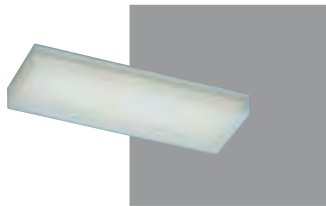

HYDRA + KSP HYDRA

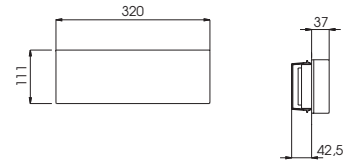

Flush Hydra
 With flush mounting accessory made of standard white and optional coloured ABS.

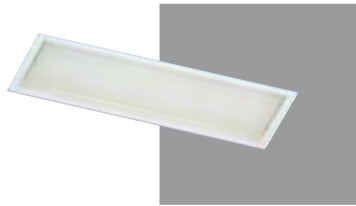

HYDRA + KETB HYDRA or KEPB HYDRA

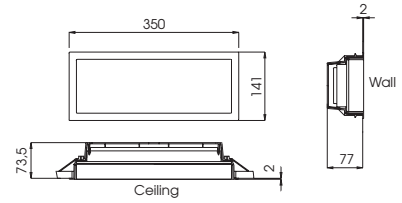

Hole required 335 mm. x 126 mm.

Hydra with protruding sign plate
 With pennant accessory made of transparent and process printed methacrylate.



HYDRA + KETB HYDRA + KSB801

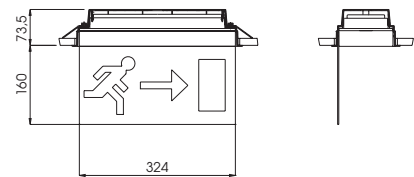

Sealed Hydra
 Box made of polycarbonate with three GAS 20 inputs, protection class IP 66 IK 08.

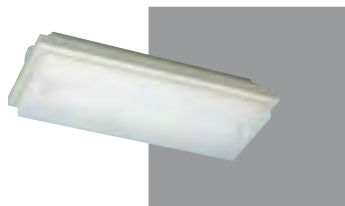

HYDRA + KES HYDRA

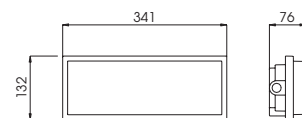

Hydra Series

This is a harmonious, discreet and unobtrusive luminaire which sets out to concede the leading role to the architecture itself.

Model	Autonomy	Lumens	Emerg. lamp	Charging monitor
Non maintained:				
HYDRA N2	1 h	95	FL 8 W	White LED
HYDRA N3	1 h	160	FL 8 W	White LED
HYDRA N5	1 h	215	FL 8 W	White LED
HYDRA N7	1 h	350	FL 8 W	White LED
HYDRA N10	1 h	450	FL 8 W	White LED
HYDRA 2N5	2 h	200	FL 8 W	White LED
HYDRA 3N4	3 h	125	FL 8 W	White LED

Model	Autonomy	Lumens	Emerg. lamp	Mains lamp	Charging monitor
Combined (1)					
HYDRA C3	1 h	145	FL 8 W	FL 8 W	White LED
HYDRA C5	1 h	200	FL 8 W	FL 8 W	White LED
HYDRA C7	1 h	325	FL 8 W	FL 8 W	White LED
HYDRA 2C5	2 h	185	FL 8 W	FL 8 W	White LED
HYDRA 3C4	3 h	115	FL 8 W	FL 8 W	White LED

Hydra A Series Specific for Self-test

Includes microprocessor for operation in Self-test mode

Model	Autonomy	Lumens	Emerg. lamp	Charging monitor
Non maintained:				
HYDRA N2 A	1 h	95	FL 8 W	White LED
HYDRA N3 A	1 h	165	FL 8 W	White LED
HYDRA N5 A	1 h	235	FL 8 W	White LED
HYDRA N7 A	1 h	370	FL 8 W	White LED
HYDRA 2N3 A	2 h	180	FL 8 W	White LED
HYDRA 3N2 A	3 h	125	FL 8 W	White LED

Combined Self-test (1)

Combined Self-test models can be supplied on request. Check with the factory.

Hydra TCA Series Specific for Self-test and DaisaTest System

Includes microprocessor for operating in Self-test mode and DaisaTest centralised management System.

TCA models can be supplied on request. **Check with the factory or our web site: www.daisalux.com**

TMA Test Central for HYDRA TCA. See page 16.

Finishes

Finish of:	Description	Marking	Resultant flux
Diffuser	Opal diffuser (standard)	----	100%
	Very opal diffuser	(MO)	63%
	Transparent diffuser	(TR)	104%

Accessories

Reference:	Description	Resultant flux
KSP HYDRA	Box for semi-recessed mounting in wall (2)	100%
KEPB HYDRA	White box for flush mounting in wall (2)	83%
KEPC HYDRA	Chrome box for flush mounting in wall (2)	83%
KEPN HYDRA	Nickel box for flush mounting in wall (2)	83%
KEPD HYDRA	Gold box for flush mounting in wall (2)	83%
KEPGP HYDRA	Silver grey box for flush mounting in wall (2)	83%
KETB HYDRA	White box for flush mounting in ceiling (2)	83%
KETGP HYDRA	Silver grey box for flush mounting in ceiling (2)	83%
KES HYDRA	Sealed box IP 66 IK 08	100%
KSH HYDRA	Kit for semi-recessing in a hollow wall	100%
RT...	Exit signs. (stickers) (See next page)	75%
KSB...	Pennant signalling kits (See next page) (3)	100%

Example of order:

Order for 35 emergency luminaires HYDRA N5, non maintained with very opal diffuser and silver grey box for flush mounting in ceiling:

35 HYDRA N5 (MO)

35 KETGP HYDRA

Operation, Common Data and Notes

- (1) Combined models have two tubes, one of which can be switched on and off with mains voltage present, while the other comes into operation in the event of a power failure. Appliances not suitable for recessing in walls or ceilings unless it is possible to guarantee that the air inside them will be refreshed.
- (2) Housing for semi-recessed and flush mounting in walls (KSP/KEP HYDRA): Suitable for installation in walls and ceilings made from breezeblock, brick, stone, etc...
Housing box for flush mounting in ceiling (KET HYDRA). Suitable for installation in walls and ceilings made from plaster board, wood, plywood, plaster, etc...
- (3) Process printed methacrylate 324x160. Accessory only suitable for KETB HYDRA and KETGP HYDRA flush ceiling mounting boxes.

Emergency signs

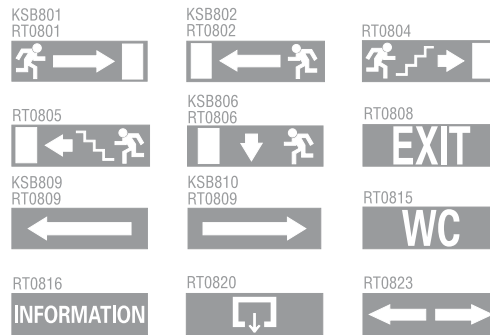

DIMENSIONS: 311 x 95 mm.

NOTE: Customized exit signs and pictograms may be supplied to order.

Photometric curves

Hydra FL

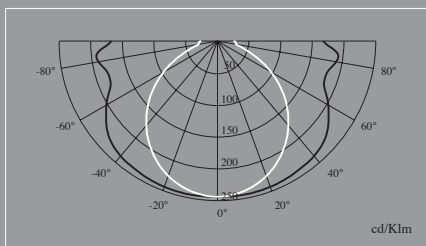

Combined Hydra

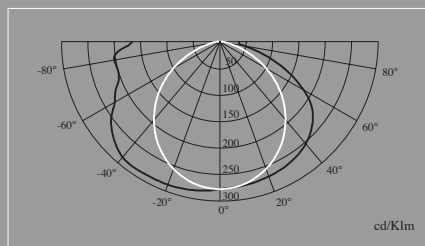

Hydra Ket

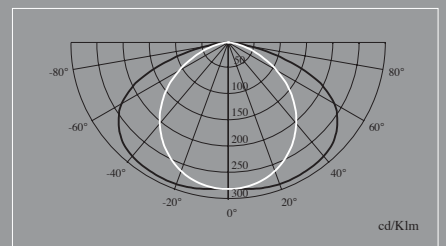

— Horizontal cut-off — Vertical cut-off



Myra Series

Constuction details: Built to EN 60598-2-22 (IEC 60598-2-22) standard / Conforming to Community Electromagnetic Compatibility, Low Voltage and **RoHS** Directives 2004/108/EC, 2006/95/EC and 2002/95/EC / Built to synthetic materials, 850°C to EN 60598-1 (IEC 60598-1) and EN 60695-2-1 (IEC 60695-2-1), according to models / Battery protected against overcurrents, excessive discharges and polarity reversal / Mains input thermal protector / Stand-by setting by remote control / Remote control circuit protected against faulty connection / Testing by remote control when mains voltage is present / Electric shock protection: Class II / Luminaire suitable for mounting on normally inflammable surfaces: Class "F" / **IP 42 IK 07** / 100% functional testing of production with computer-electronic systems.







Surface Myra

Base, reflector and diffuser support made of PC-ASA.

Colours: white standard, metallic dark grey and silver grey optional. Transparent, opal or very opal polycarbonate diffuser.

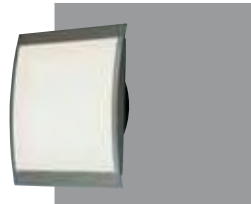

MYRA (GREY)

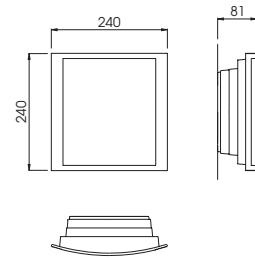

Semi-recessed Myra wall/ceiling
With semi-recessing accessory.

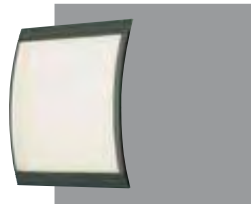

MYRA (GREY)
+ KST IMNS or KSP IMNS

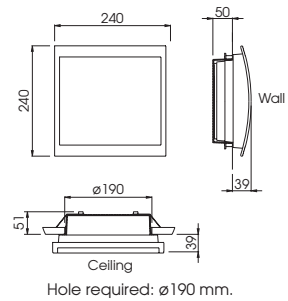

Hole required: $\varnothing 190$ mm.

Myra Series

With a greater concession to image, especially on account of its different white, silver grey and metallic dark grey finishes, but with no intention of going beyond the bounds of the limits established between the emergency luminaire and any architectural space.

Model	Autonomy	Lumens	Emerg. lamp		Charging monitor
Non maintained:					
MYRA N2	1 h	75	FL 4 W		White LED
MYRA N5	1 h	195	2D 16 W		White LED
MYRA N6	1 h	255	2D 16 W		White LED
MYRA N8	1 h	420	2D 16 W		White LED
MYRA N11	1 h	550	2D 16 W		White LED
MYRA 2N6	2 h	295	2D 16 W		White LED
MYRA 3N4	3 h	180	2D 16 W		White LED
Model	Autonomy	Lumens	Emerg. lamp	Mains lamp	Charging monitor
Maintained (1)					
MYRA P6	1 h	230	2D 16 W	2D 16 W	White LED
Model	Autonomy	Lumens	Emerg. lamp	Mains lamp	Charging monitor
Combined (2)					
MYRA C2	1 h	75	FL 4 W	FL 4 W	White LED
MYRA 2C2	2 h	75	FL 4 W	FL 4 W	White LED
MYRA 3C2	3 h	75	FL 4 W	FL 4 W	White LED

Myra A Series Specific for Self-test

Includes microprocessor for operation in Self-test mode

Model	Autonomy	Lumens	Emerg. lamp		Charging monitor
Non maintained:					
MYRA N2 A	1 h	85	FL 4 W		White LED
MYRA N5 A	1 h	230	2D 16 W		White LED
MYRA N6 A	1 h	270	2D 16 W		White LED
MYRA N8 A	1 h	400	2D 16 W		White LED
MYRA N10 A	1 h	550	2D 16 W		White LED
MYRA 2N6 A	2 h	275	2D 16 W		White LED
MYRA 3N2 A	3 h	85	FL 4 W		White LED

Myra TCA Series Specific for Self-test and DaisaTest System

Includes microprocessor for operating in Self-test mode and DaisaTest centralised management System.

TCA models can be supplied on request. **Check with the factory or our web site: www.daisalux.com**
TMA Test Central for MYRA TCA. See page 16.

Finishes

Finish of:	Description	Marking	Resultant flux
Colour	White (standard)	----	----
	Metallic dark grey	(GREY)	----
	Silver grey	(RAL9006)	----
Diffuser	Opal (standard) (3)	----	100%
	Very opal Myra (3)	(M0)	55%
	Transparent with exit sign (4)	(RT.../PI...)	35%

Accessories

Reference:	Description	Resultant flux
KST IMNS	Box for semi-recessing in ceiling (5)	100%
KSP IMNS	Bow for semi-recessing in wall (5)	100%
RT.../PI...	Exit signs (stickers) (4) (See next page)	35%

Example of order:

Order for 20 emergency luminaires MYRA N6, non maintained, surface mounting in metallic dark grey and with very opal diffuser:

20 MYRA N6 (GREY, M0)

Operation, Common Data and Notes

- (1) Appliances not suitable for recessing in walls or ceilings unless it is possible to guarantee that the air inside them will be refreshed. This model doesn't contain remote control connection.
- (2) Combined models have two tubes, one of which can be switched on and off with mains voltage present, while the other comes into operation in the event of a power failure. Appliances not suitable for recessing in walls or ceilings unless it is possible to guarantee that the air inside them will be refreshed. This model doesn't contain remote control connection.
- (3) Signs are not compatible with opal or very opal diffusers.
- (4) Emergency signs consist of a strip of polycarbonate inserted in a transparent diffuser. They come fitted.
- (5) Housing box for semi-recessed installation in walls (KSP IMNS): Suitable for installation in ceilings and walls made from breezeblock, brick, stone, etc.
Housing box for semi-recessed installation in ceilings (KST IMNS): Suitable for installation in walls and ceilings made from plaster board, wood, plywood, plaster, etc.

Signaling pictograms



Exit signs

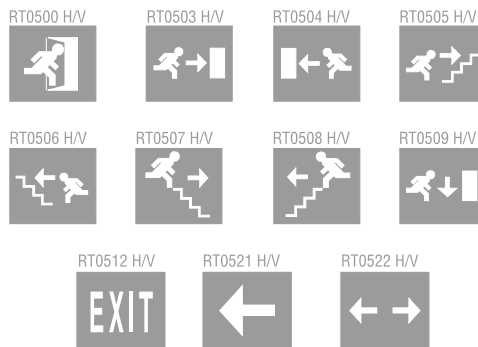

DIMENSIONS: 208,5 x 184,5 mm. 

NOTE: Customized signs and pictograms may be supplied to order.

Photometric curves

Myra 2D 16W

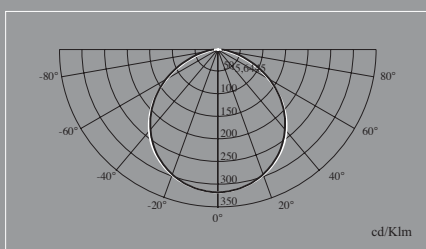

Myra FL 4W

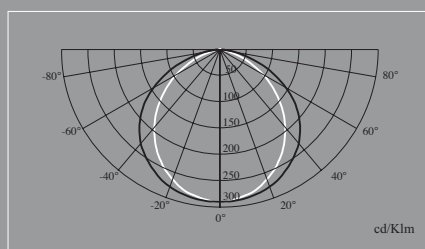

Combined Myra

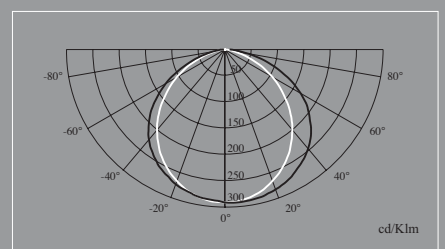

— Horizontal cut-off — Vertical cut-off



Norma Series

Construction details: Built to EN 60598-2-22 (IEC 60598-2-22) standard / Conforming to Community Electromagnetic Compatibility, Low Voltage and **RoHS** Directives 2004/108/EC, 2006/95/EC and 2002/95/EC / Built to synthetic materials, 850°C to EN 60598-1 (IEC 60598-1) and EN 60695-2-1 (IEC 60695-2-1), according to models / Battery protected against excessive discharges and polarity reversal / Stand-by setting by remote control / Remote control circuit protected against faulty connection / Testing by remote control when mains voltage is present / Electric shock protection: Class II / Luminaire suitable for mounting on normally inflammable surfaces: Class "F" / **IP 42 IK 04** / Mains input thermal protector / 100% functional testing of production with computer-electronic systems.





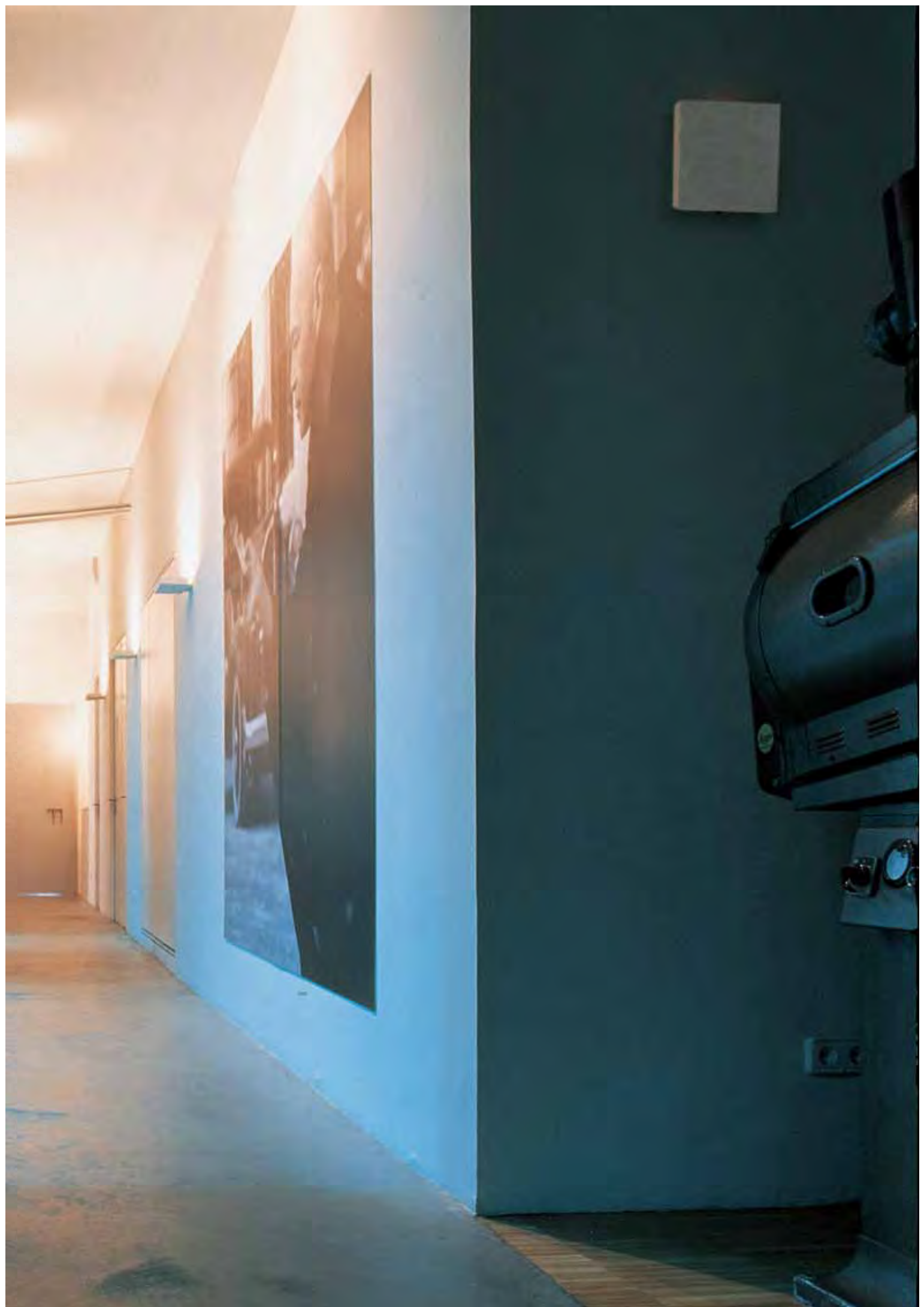

Surface Norma

Base, reflector and diffuser support made of PC-ASA, diffuser of opal or very opal polycarbonate.



NORMA

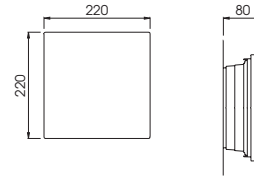

Semi-recessed Norma, wall/ceiling
With semi-recessing accessory.



NORMA + KST IMNS or
KSP IMNS

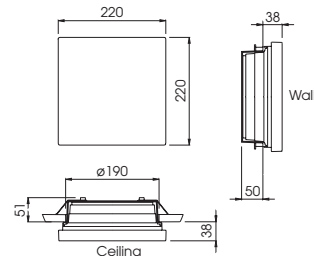

Hole required: \varnothing 190 mm.

Recessed Norma

Housing made from plastic materials that comply with the incandescent wire test at 850°C; opal or very opal polycarbonate diffuser.

With accessory for recessing in hollow partition walls or false ceilings.



NORMA + KET NORMA

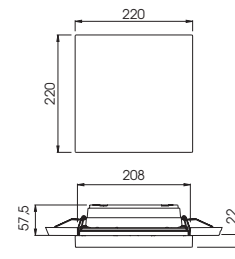

Hole required 208x208 mm.

Flush Norma

External dimensions 253x253 mm.

With accessory for flush-fit installation in hollow partition walls or false ceilings.



NORMA + KENTB NORMA

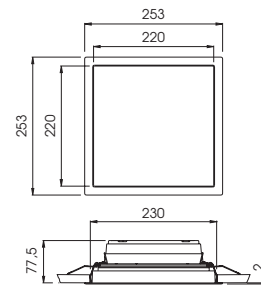

Hole required 230x230 mm.

Flush Norma (Z)

External dimensions 240x240 mm.

With accessory for flush-fit installation in hollow partition walls or false ceilings.



NORMA + KENTB-Z NORMA

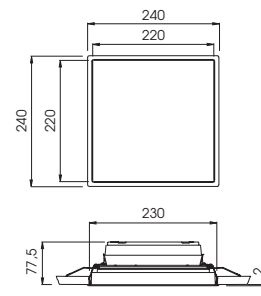

Hole required 230x230 mm.

Norma Series

Based on basic geometric forms, with essential lines which ensure that it will blend in discreetly with the most minimalist architectural setting.

Model	Autonomy	Lumens	Emerg. Lamp	Charging monitor
Non maintained:				
NORMA N2	1 h	70	FL 4 W	White LED
NORMA N5	1 h	180	2D 16 W	White LED
NORMA N6	1 h	235	2D 16 W	White LED
NORMA N8	1 h	390	2D 16 W	White LED
NORMA N11	1 h	500	2D 16 W	White LED
NORMA 2N6	2 h	270	2D 16 W	White LED
NORMA 3N4	3 h	165	2D 16 W	White LED

Model	Autonomy	Lumens	Emerg. Lamp	Mains Lamp	Charging monitor
Maintained (1)					
NORMA P6	1 h	215	2D 16 W	2D 16 W	White LED

Model	Autonomy	Lumens	Emerg. Lamp	Mains Lamp	Charging monitor
Combined (2)					
NORMA C2	1 h	70	FL 4 W	FL 4 W	White LED
NORMA 2C2	2 h	70	FL 4 W	FL 4 W	White LED
NORMA 3C2	3 h	70	FL 4 W	FL 4 W	White LED

Norma A Series Specific for Self-test

Includes microprocessor for operation in Self-test mode

Model	Autonomy	Lumens	Emerg. Lamp	Charging monitor
Non maintained:				
NORMA N2 A	1 h	80	FL 4 W	White LED
NORMA N5 A	1 h	210	2D 16 W	White LED
NORMA N6 A	1 h	245	2D 16 W	White LED
NORMA N8 A	1 h	370	2D 16 W	White LED
NORMA N10 A	1 h	500	2D 16 W	White LED
NORMA 2N6 A	2 h	250	2D 16 W	White LED
NORMA 3N2 A	3 h	80	FL 4 W	White LED

Norma TCA Series Specific for Self-test and DaisaTest System

Includes microprocessor for operating in Self-test mode and DaisaTest centralised management System.

TCA models can be supplied on request. **Check with the factory or our web site: www.daisalux.com**

TMA Test Central for NORMA TCA. See page 16.

Finishes

Finish of:	Description	Marking	Resultant flux
Diffuser	Opal (standard)	----	100%
	Very opal Norma	(M0)	70%

Accessories

Reference:	Description	Resultant flux
KST IMNS	Box for semi-recessing in ceiling (3)	100%
KSP IMNS	Box for semi-recessing in wall (3)	100%
KET NORMA	Recessed ceiling kit (5)	100%
KENTB NORMA	White flush mounting kit for ceiling (4)(5)	85%
KENTB-Z NORMA	White flush mounting kit for ceiling (4)(5)	85%
KENTNE NORMA	Black flush mounting kit for ceiling (4)(5)	85%
KENTNE-Z NORMA	Black flush mounting kit for ceiling (4)(5)	85%
RT...	Exit signs. (stickers)	55%
	(See next page)	

Example of order:

Order for 15 emergency luminaires NORMA 3C2, combined with box for semi-recessing in wall and exit sign:

15 NORMA 3C2

15 KSP IMNS

15 RT0708

Operation, Common Data and Notes

- (1) Appliances not suitable for recessing in walls or ceilings unless it is possible to guarantee that the air inside them will be refreshed. This model doesn't contain remote control connection.
- (2) Combined models have two tubes, one of which can be switched on and off with mains voltage present, while the other comes into operation in the event of a power failure. Appliances not suitable for recessing in walls or ceilings unless it is possible to guarantee that the air inside them will be refreshed. This model does not contain remote control connection.
- (3) Housing box for semi-recessed installation in walls (KSP IMNS): Suitable for installation in ceilings and walls made from breezeblock, brick, stone, etc.
Housing box for semi-recessed installation in ceilings (KST IMNS): Suitable for installation in walls and ceilings made from plaster board, wood, plywood, plaster, etc.
- (4) Check with the factory for other colours of the flush-installation kit.
- (5) Installation in false ceiling or hollow partition wall.

Emergency signs

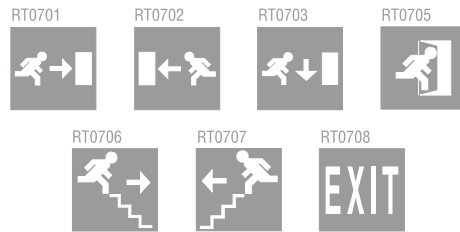

DIMENSIONS: 208 X 208 mm. □

NOTE: Customized signs and pictograms may be supplied to order.

Photometric curves

Norma FL 4W

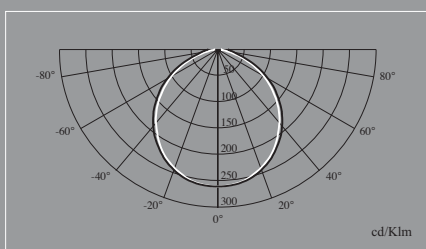

Norma 2D 16W

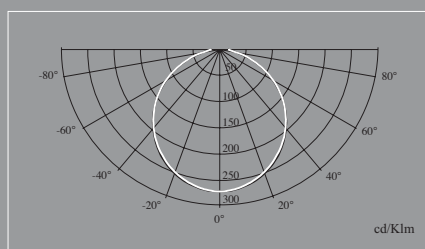

Combined Norma

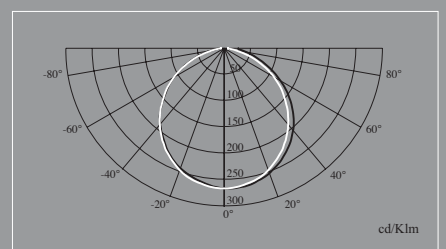

— Horizontal cut-off — Vertical cut-off

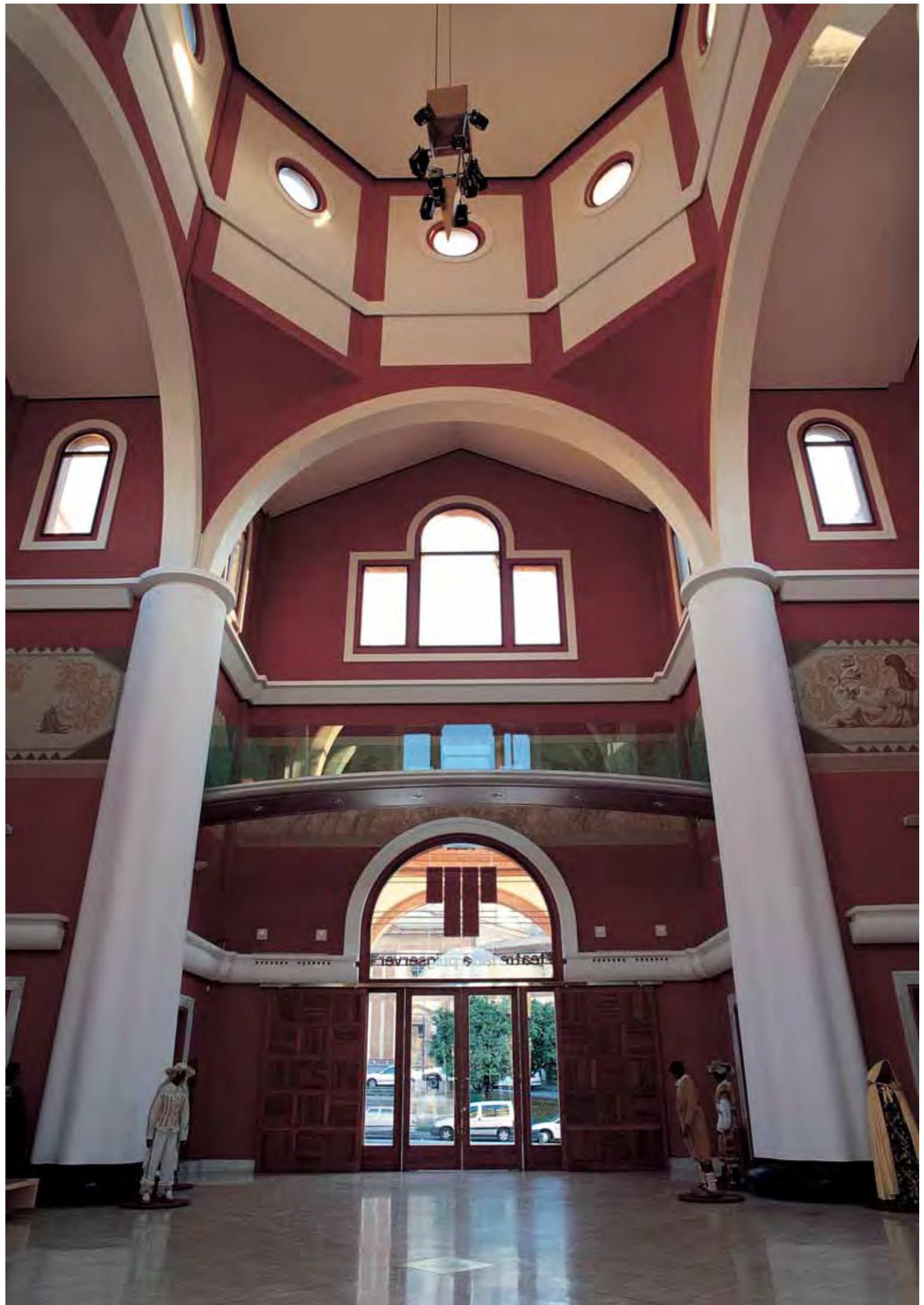

Iris Series

Construction details: Built to EN 60598-2-22 (IEC 60598-2-22) standard / Conforming to Community Electromagnetic Compatibility, Low Voltage and **RoHS** Directives 2004/108/EC, 2006/95/EC and 2002/95/EC / Built to synthetic materials, 850°C to EN 60598-1 (IEC 60598-1) and EN 60695-2-1 (IEC 60695-2-1), according to models / Battery protected against excessive discharges and polarity reversal / Mains input thermal protector / Standby setting by remote control / Remote control circuit protected against faulty connection / Test by remote control when mains voltage is present / Electric shock protection: Class II / Luminaire suitable for mounting on normally inflammable surfaces: Class "F" / **IP 42 IK 07** / 100% functional testing of production with computer-electronic systems.







Surface Iris

Base, reflector and diffuser support made of PC-ASA. Colours: white standard, metallic dark grey and silver grey optional. Diffuser made of transparent, opal or dark opal polycarbonate.



IRIS (GREY)

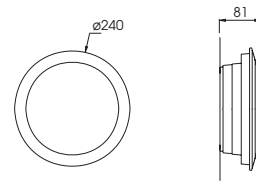

Semi-recessed Iris for wall/ceiling
With semi-recessing accessory.



IRIS (GREY)
+ KST IMNS or KSP IMNS

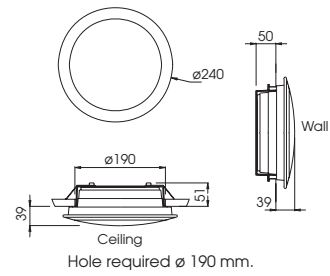

Hole required \varnothing 190 mm.

Recessed Iris for wall/ceiling
With recessing accessory.



IRIS (GREY)
+ KET IRIS or KEP IRIS/SOL

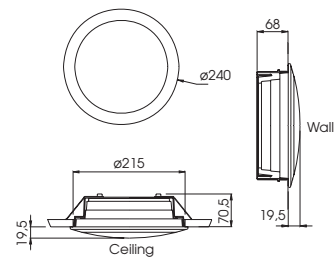

Hole required \varnothing 215 mm.

Iris Series

With a greater concession to image, specially on account of its different white, silver grey and metallic dark grey finishes, but with no intention of going beyond the bounds of the limits established between the emergency luminaire and any architectural space.

Model	Autonomy	Lumens	Emerg. lamp		Charging monitor
Non maintained:					
IRIS N2	1 h	70	FL 4 W		White LED
IRIS N5	1 h	180	2D 16 W		White LED
IRIS N6	1 h	235	2D 16 W		White LED
IRIS N8	1 h	390	2D 16 W		White LED
IRIS N11	1 h	500	2D 16 W		White LED
IRIS 2N6	2 h	270	2D 16 W		White LED
IRIS 3N4	3 h	165	2D 16 W		White LED
Model	Autonomy	Lumens	Emerg. lamp	Mains lamp	Charging monitor
Maintained (1)					
IRIS P6	1 h	215	2D 16 W	2D 16 W	White LED
Model	Autonomy	Lumens	Emerg. lamp	Mains lamp	Charging monitor
Combined (2)					
IRIS C2	1 h	70	FL 4 W	FL 4 W	White LED
IRIS 2C2	2 h	70	FL 4 W	FL 4 W	White LED
IRIS 3C2	3 h	70	FL 4 W	FL 4 W	White LED

Iris A Series Specific for Self-test

Includes microprocessor for operation in Self-test mode

Model	Autonomy	Lumens	Emerg. lamp		Charging monitor
Non maintained:					
IRIS N2 A	1 h	80	FL 4 W		White LED
IRIS N5 A	1 h	210	2D 16 W		White LED
IRIS N6 A	1 h	245	2D 16 W		White LED
IRIS N8 A	1 h	370	2D 16 W		White LED
IRIS N10 A	1 h	500	2D 16 W		White LED
IRIS 2N6 A	2 h	250	2D 16 W		White LED
IRIS 3N2 A	3 h	80	FL 4 W		White LED

Iris TCA Series Specific for Self-test and DaisaTest System

Includes microprocessor for operating in Self-test mode and DaisaTest centralised management System.

TCA models can be supplied on request. **Check with the factory or our web site: www.daisalux.com**

TMA Test Central for IRIS TCA. See page 16.

Finishes

Finish of:	Description	Marking	Resultant flux
Colour	White (standard)	----	----
	Metallic dark grey	(GREY)	----
	Silver grey	(RAL9006)	----
Diffuser	Opal (standard) (3)	----	100%
	Very opal Iris (3)	(M0)	55%
	Transparent with exit sign (4)	(RT...)	45%

Accessories

Reference:	Description	Resultant flux
KST IMNS	Box for semi-recessing in ceiling (5)	100%
KSP IMNS	Box for semi-recessing in wall (5)	100%
KET IRIS	Box for recessing in ceiling (5)	100%
KEP IRIS/SOL	Box for recessing in wall (5)	100%
RT...	Exit signs (4) (see next page)	45%

Example of order:

Order for 50 emergency luminaires IRIS N6, non maintained, in metallic dark grey with exit sign:

50 IRIS N6 (GREY, RT0400)

Operation, Common Data and Notes

- (1) Appliances not suitable for recessing in walls or ceilings unless it is possible to guarantee that the air inside them will be refreshed. This model doesn't contain remote control connection.
- (2) Combined models have two tubes, one of which can be switched on and off with mains voltage present, while the other comes into operation in the event of a power failure. Appliances not suitable for recessing in walls or ceilings unless it is possible to guarantee that the air inside them will be refreshed. This model doesn't contain remote control connection.
- (3) Signs are not compatible with opal or very opal diffusers.
- (4) Exit signs consist of a strip of polycarbonate inserted in a transparent diffuser. They come fitted.
- (5) Housing box for semi-recessed and flush mounting in walls (KSP IMNS, KEP IRIS/SOL): Suitable for installation in ceilings and walls made from breezeblock, brick, stone, etc.
Housing box for semi-recessed and flush mounting in ceilings (KST IMNS, KET IRIS): Suitable for installation in walls and ceilings made from plaster board, wood, plywood, plaster, etc.

Emergency signs

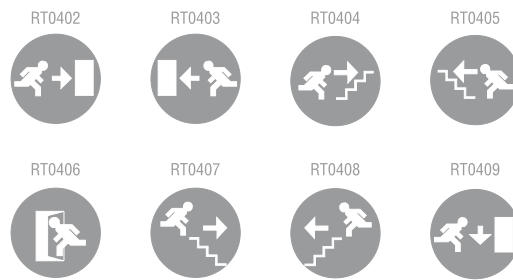

DIMENSIONS: 185 mm. Ø 

NOTE: Customized signs and pictograms may be supplied to order.

Photometric curves

Iris FL 4W

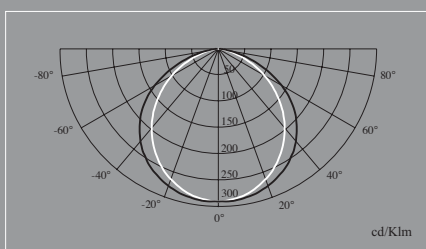

Iris 2D 16W

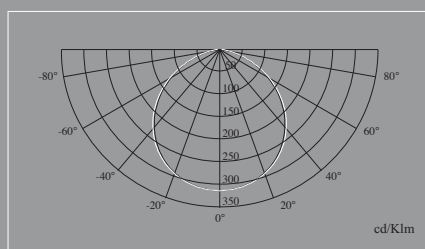

Combined Iris

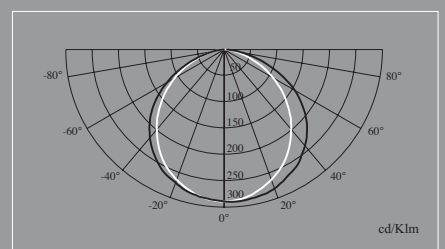

— Horizontal cut-off — Vertical cut-off

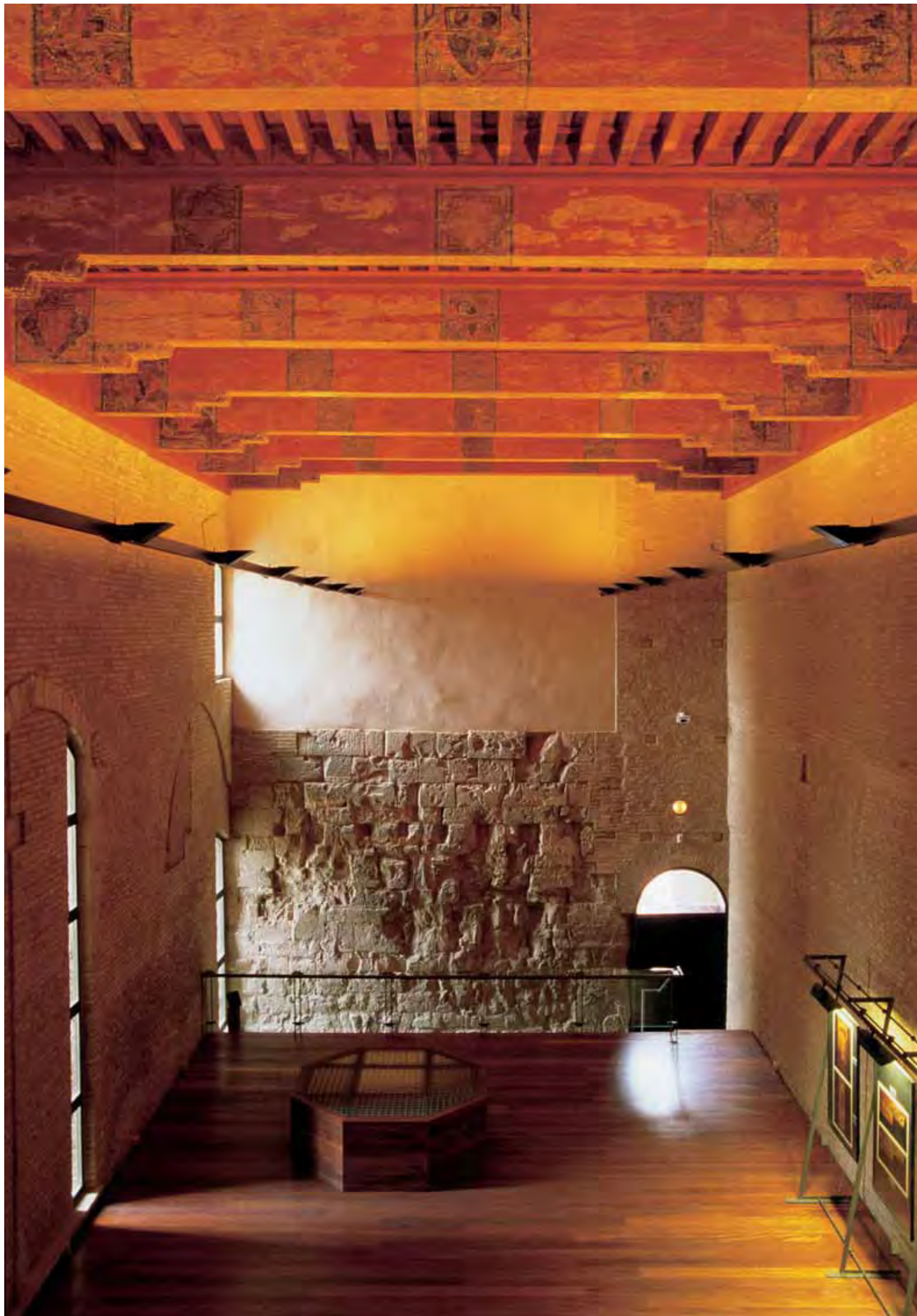

Sol Series

Construction details: Built to EN 60598-2-22 (IEC 60598-2-22) standard / Conforming to Community Electromagnetic Compatibility, Low Voltage and **RoHS** Directives 2004/108/EC, 2006/95/EC and 2002/95/EC / Built to synthetic materials, 850°C to EN 60598-1 (IEC 60598-1) and EN 60695-2-1 (IEC 60695-2-1), according to models / Battery protected against excessive discharges and polarity reversal / Standby setting by remote control / Remote control circuit protected against faulty connection / Test by remote control when mains voltage is present / Electric shock protection: Class II / Luminaire suitable for mounting on normally inflammable surfaces: Class "F" / **IP 42 IK 07** / Mains input thermal protector / 100% functional testing of production with computer-electronic systems.



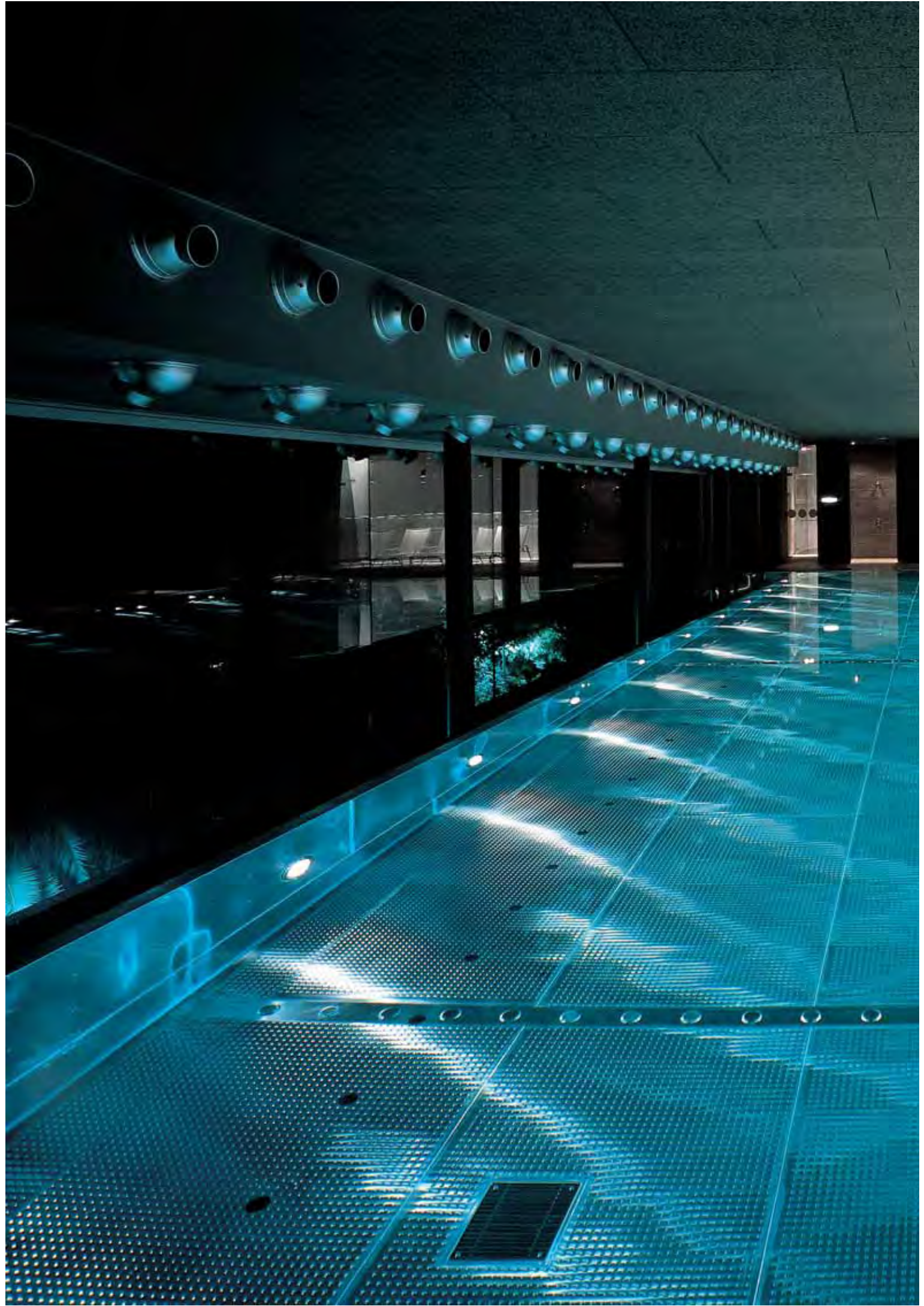



Surface Sol

Base, reflector and diffuser support made of PC-ASA, opal or very opal polycarbonate diffuser.



SOL

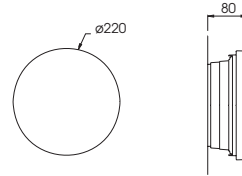

Semi-recessed Sol, wall/ceiling
With semi-recessing accessory.



SOL + KST IMNS or
KSP IMNS

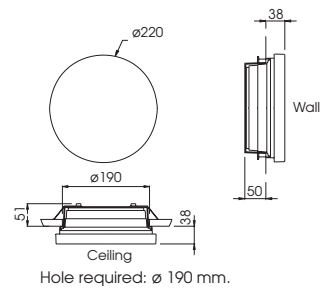

Recessed Sol, wall/ceiling
With recessing accessory.



SOL + KET SOL or
KEP IRIS/SOL

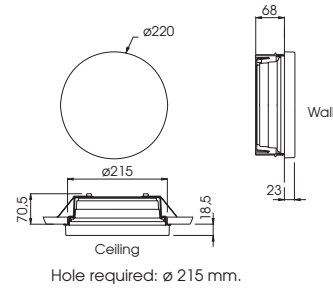

Flush Sol, wall/ceiling
With flush-fitting accessory.
Colours: white, chrome, nickel
and gold.



SOL + KENTB SOL or
KENPB SOL

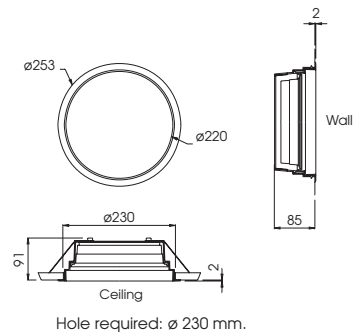

Sol Series

Based on basic geometric forms, with essential lines which ensure that it will blend in discreetly with the most minimalist architectural setting.

Model	Autonomy	Lumens	Emerg. lamp		Charging monitor
Non maintained:					
SOL N2	1 h	70	FL 4 W		White LED
SOL N5	1 h	180	2D 16 W		White LED
SOL N6	1 h	235	2D 16 W		White LED
SOL N8	1 h	390	2D 16 W		White LED
SOL N11	1 h	500	2D 16 W		White LED
SOL 2N6	2 h	270	2D 16 W		White LED
SOL 3N4	3 h	165	2D 16 W		White LED
Model	Autonomy	Lumens	Emerg. lamp	Mains lamp	Charging monitor
Maintained (1)					
SOL P6	1 h	215	2D 16 W	2D 16 W	White LED
Model	Autonomy	Lumens	Emerg. lamp	Mains lamp	Charging monitor
Combined (2)					
SOL C2	1 h	70	FL 4 W	FL 4 W	White LED
SOL 2C2	2 h	70	FL 4 W	FL 4 W	White LED
SOL 3C2	3 h	70	FL 4 W	FL 4 W	White LED

Sol A Series Specific for Self-test

Includes microprocessor for operation in Self-test mode

Model	Autonomy	Lumens	Emerg. lamp		Charging monitor
Non maintained:					
SOL N2 A	1 h	80	FL 4 W		White LED
SOL N5 A	1 h	210	2D 16 W		White LED
SOL N6 A	1 h	245	2D 16 W		White LED
SOL N8 A	1 h	370	2D 16 W		White LED
SOL N10 A	1 h	500	2D 16 W		White LED
SOL 2N6 A	2 h	250	2D 16 W		White LED
SOL 3N2 A	3 h	80	FL 4 W		White LED

Sol TCA Series Specific for Self-test and DaisaTest System

Includes microprocessor for operating in Self-test mode and DaisaTest centralised management System. TCA models can be supplied on request. **Check with the factory or our web site: www.daisalux.com**
TMA Test Central for SOL TCA. See page 16.

Finishes

Finish of:	Description	Marking	Resultant flux
Diffuser	Opal (standard)	----	100%
	Very opal Sol	(M0)	70%

Accessories

Reference:	Description	Resultant flux
KST IMNS	Box for semi-recessing in ceiling (3)	100%
KSP IMNS	Box for semi-recessing in wall (3)	100%
KET SOL	Box for recessing in ceiling (3)	100%
KEP IRIS/SOL	Box for recessing in wall (3)	100%
KENTB SOL	White box for flush mounting in ceiling (3)	82%
KENTC SOL	Chrome box for flush mounting in ceiling (3)	82%
KENTN SOL	Nickel box for flush mounting in ceiling (3)	82%
KENTD SOL	Gold box for flush mounting in ceiling (3)	82%
KENTGP SOL	Silver grey box for flush mounting in ceiling (3)	82%
KENPB SOL	White box for flush mounting in wall (3)	82%
KENPC SOL	Chrome box for flush mounting in wall (3)	82%
KENPN SOL	Nickel box for flush mounting in wall (3)	82%
KENPD SOL	Gold box for flush mounting in wall (3)	82%
KENPGP SOL	Silver grey box for flush mounting in wall (3)	82%
RT...	Exit signs (stickers)	55%
	(See next page)	

Example of order:

Order for 25 emergency luminaires SOL N8, non maintained with very opal diffuser and chrome box for flush mounting in wall:

25 SOL N8 (M0)
25 KENPC SOL

Operation, Common Data and Notes

- (1) Appliances not suitable for recessing in walls or ceilings unless it is possible to guarantee that the air inside them will be refreshed. This model does not contain remote control connection.
- (2) Combined models have two tubes, one of which can be switched on and off with mains voltage present, while the other comes into operation in the event of a power failure. Appliances not suitable for recessing in walls or ceilings unless it is possible to guarantee that the air inside them will be refreshed. This model doesn't contain remote control connection.
- (3) Housing box for semi-recessed, recessed and flush mounting in walls (KSP IMNS, KEP IRIS/SOL, KENP SOL): Suitable for installation in ceilings and walls made from breezeblock, brick, stone, etc.
Housing box for semi-recessed, recessed and flush mounting in ceilings (KST IMNS, KET SOL, KENT SOL): Suitable for installation in walls and ceilings made from plaster board, wood, plywood, plaster, etc

Emergency signs

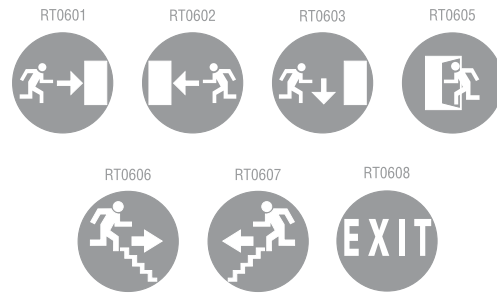

DIMENSIONS: 208 mm. Ø 

NOTE: Customized signs and pictograms may be supplied to order.

Photometric curves

So1 FL 4W

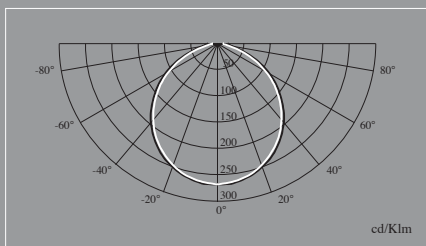

So1 2D 16W

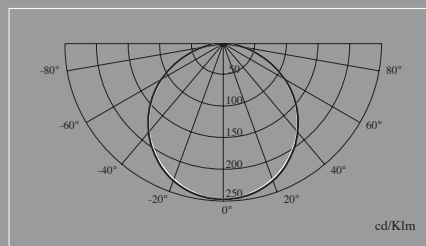

Combined So1

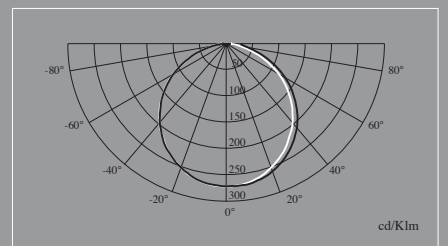

— Horizontal cut-off — Vertical cut-off



Luna Series

Construction details: Built to EN 60598-2-22 (IEC 60598-2-22) standard / Conforming to Community Electromagnetic Compatibility, Low Voltage and **RoHS** Directives 2004/108/EC, 2006/95/EC and 2002/95/EC / Built to synthetic materials, 850°C to EN 60598-1 (IEC 60598-1) and EN 60695-2-1 (IEC 60695-2-1), according to models / Mains input thermal protector / Battery protected against excessive discharges and polarity reversal / Stand-by setting by remote control / Remote control circuit protected against faulty connection / Testing by remote control when mains voltage is present / Electric shock protection: Class II / Luminaire suitable for mounting on normally inflammable surfaces: Class "F" / **IP 42 IK 04** / 100% functional testing of production with computer-electronic systems.







Surface Luna
 Base and reflector made of white PC-ASA. Opal polycarbonate diffuser.



LUNA

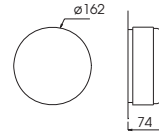

Recessed Luna
 With recessing accessory made of white ABS.



LUNA + KET LUNA

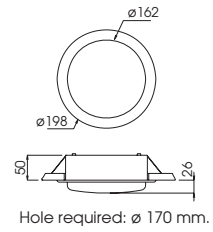

Suspended Luna
 Chromed and polished metal tube and retaining ring. Polycarbonate connecting support and chromed metal rosette.



SUSPENDED LUNA

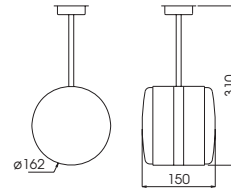

Luna Series

It is denoted for its small dimensions and because Daisalux introduces for the first time a new concept, the flag concept. These may be the reasons that now make it exceptionally compatible with the latest architectural proposals.

Model	Autonomy	Lumens	Emerg. lamp	Charging monitor
Non maintained:				
LUNA N2	1 h	55	FL 4 W	White LED
LUNA N3	1 h	110	FL 4 W	White LED
LUNA-B N2	1 h	110	2 x FL 4 W	White LED
LUNA-B N3	1 h	220	2 x FL 4 W	White LED
Finishes				
Finish of: Colour	Description White (standard)			Marking ----
Accessories				
Reference:	Description			Resultant flux
KET LUNA	Box for recessing (1)(2)			100%
RT...	Exit signs (stickers) (See page 104)			55%

Example of order:

Order for 10 emergency luminaires LUNA N3, non maintained and recessed:

10 LUNA N3

10 KET LUNA

Operation, Common Data and Notes

(1) Valid only for models LUNA N2 and LUNA N3.

(2) Recessed housing box (KET LUNA): Suitable for installation in walls and ceilings made from plaster board, wood, plywood, plaster, etc.

Emergency signs

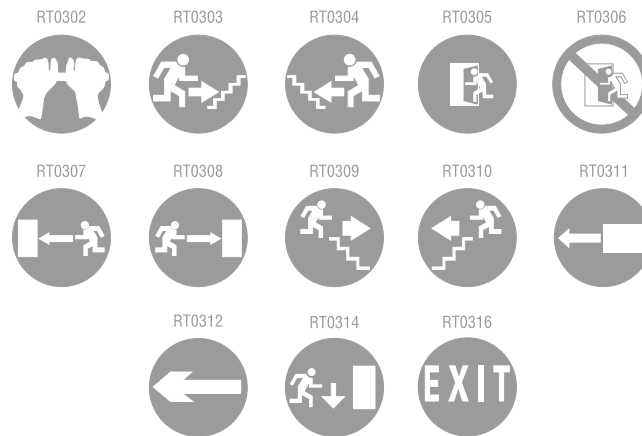

DIMENSIONS: 140 mm. Ø 

NOTE: Customized signs and pictograms may be supplied to order.

Photometric curves

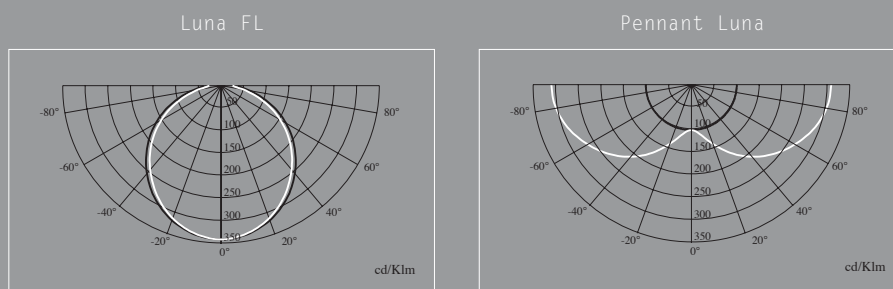

— Horizontal cut-off — Vertical cut-off

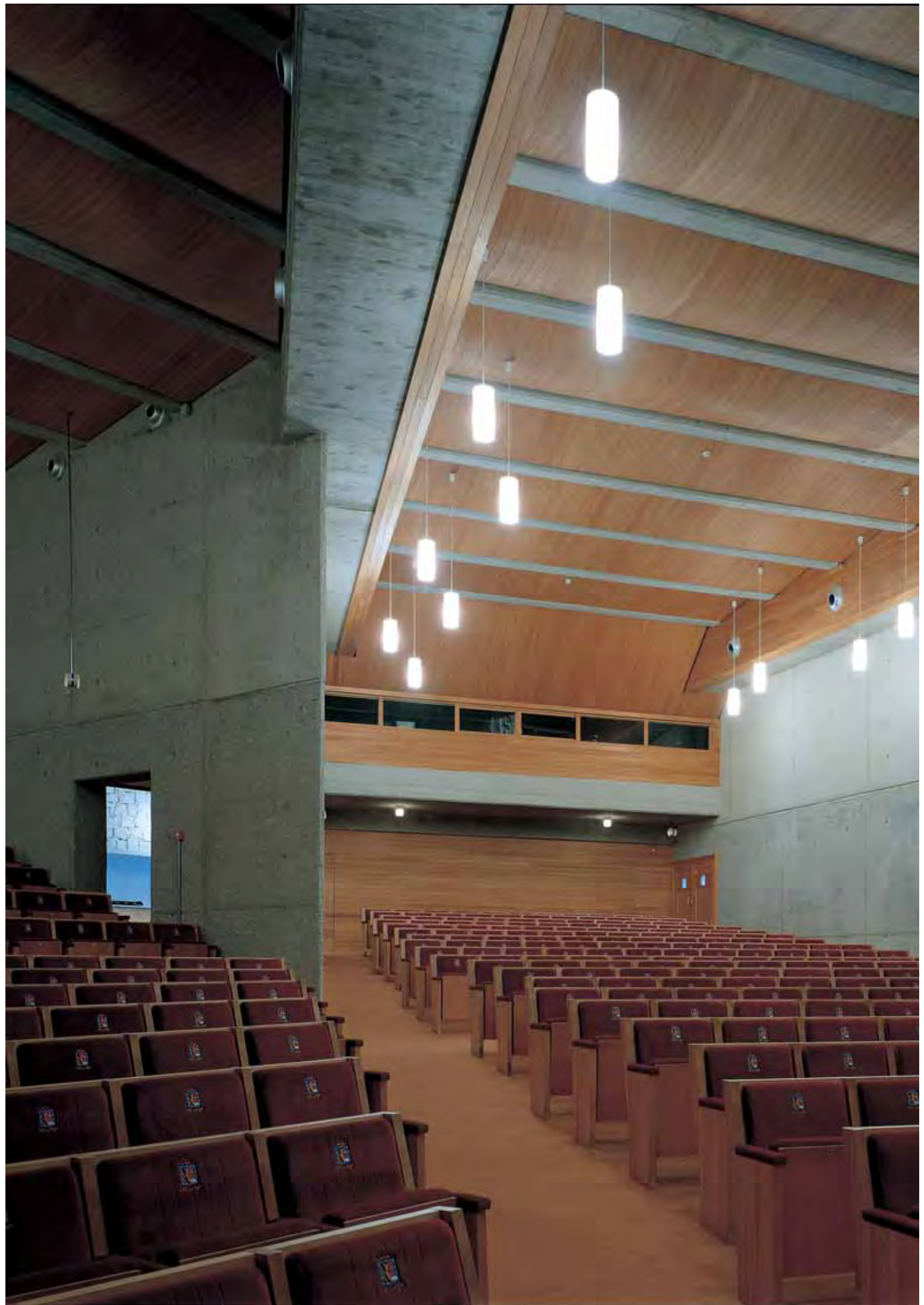

Explosion Proof Series

Construction details: Built to EN 60598-2-22 (IEC 60598-2-22), EN 50014 (IEC 50014), EN 50018 (IEC 50018), EN 50281-1-1 (IEC 50281-1-1) standards / Conforming to Community Electromagnetic Compatibility, Explosive Atmosphere and **RoHS** European Directives 2004/108/EC, 94/9/EC and 2002/95/EC / Classification: II2G EEx d IIC T6 - II2D IP 67 T85°C / Built to synthetic materials, 850°C to EN 60598-1 (IEC 60598-1) and EN 60695-2-1 (IEC 60695-2-1), according to models / Battery protected against excessive discharges and polarity reversal / Fast-on terminals / Setting on stand-by by remote control / Remote control circuit protected against connection errors / Testing by remote control when mains voltage is present / Protection against electric shocks: Class I / **IP 67 IK 04** / Mains input thermal protector / 100% functional testing of production with computer-electronic systems.







Explosion proof
Copper-free aluminium
alloy housing. 2 ISO 7/1
inputs (compatible with
taper gas thread) one with
a cap.



EXPLOSION PROOF

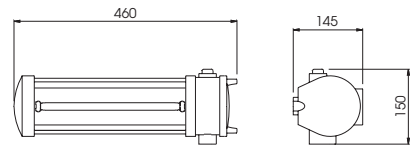

Explosion proof Series

Its frame and aluminium and boron silicate glass materials make it particularly suited for installation in an industrial architectural environment.

Model	Autonomy	Lumens	Emerg. lamp	Charging monitor
Non maintained:				
ANTIDFLAGRANTE N6	1 h	285	FL 8 W	White LED
ANTIDFLAGRANTE N11	1 h	620	PL 11 W	White LED
ANTIDFLAGRANTE 3N4	3 h	190	FL 8 W	White LED

Model	Autonomy	Lumens	Emerg. lamp	Mains lamp	Charging monitor
Combined (1)					
ANTIDFLAGRANTE C6	1 h	270	FL 8 W	FL 8 W	White LED
ANTIDFLAGRANTE 3C4	3 h	180	FL 8 W	FL 8 W	White LED

Explosion proof A Series Specific for Self-test

Includes microprocessor for operation in Self-test mode

Model	Autonomy	Lumens	Emerg. lamp	Charging monitor
Non maintained:				
ANTIDFLAGRANTE N6 A	1 h	280	FL 8 W	White LED
ANTIDFLAGRANTE N10 A	1 h	535	PL 11 W	White LED
ANTIDFLAGRANTE 3N3 A	3 h	140	FL 8 W	White LED

Combined Self-test (1)

Combined Self-test models can be supplied on request. Check with the factory.

Explosion proof TCA Series Specific for Self-test and DaisaTest System

Includes microprocessor for operating in Self-test mode and DaisaTest centralised management System. TCA models can be supplied on request. **Check with the factory or our web site: www.daisalux.com**
TMA Test Central for EXPLOSION PROOF TCA. See page 16.

Example of order:

Order for 20 emergency luminaires ANTIDFLAGRANTE N6, non maintained:

30 ANTIDFLAGRANTE N6

Operation, Common Data and Notes

(1) Combined models have two tubes, one of which can be switched on and off with mains voltage present, while the other comes into operation in the event of a power failure.

EC Examination Certificate type LOM 03ATEX2112 X according to Directive 94/9/EC. **NOT SUITABLE FOR MINES.**

Photometric curves

Combined Explosion proof

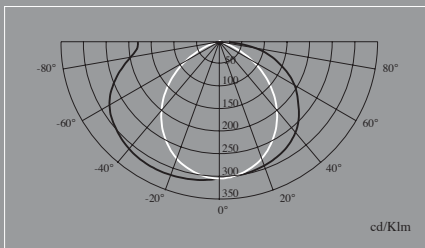

FL Explosion proof

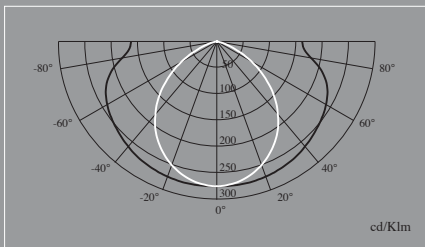

PL Explosion proof

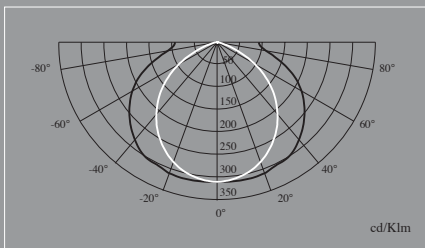

— Horizontal cut-off — Vertical cut-off





DURST MALTA
MALTA CARAPAX

Zenit Series

Construction details: Built to EN 60598-2-22 (IEC 60598-2-22) standard / Conforming to Community Electromagnetic Compatibility, Low Voltage and **RoHS** Directives 2004/108/EC, 2006/95/EC and 2002/95/EC / Built to synthetic materials, 850°C to EN 60598-1 (IEC 60598-1) and EN 60695-2-1 (IEC 60695-2-1), according to models / Battery protected against overcurrents, excessive discharges and polarity reversal / Low heat-emitting, double charging rate charger / Stand-by and emergency setting by remote control / Remote control circuit protected against faulty connection / Autonomy testing by remote control when mains voltage is present / Electric shock protection: Class II / Luminaire suitable for mounting on normally inflammable surfaces: Class "F" / **IP 42 IK 04** / Mains input thermal protector / Quick connection terminal / Moving limited turn swivel / 100% functional testing of production with computer-electronic systems.







Large 4-spot Zenit: Z4G
 Housing made of PC-ASA.
 Colours: standard white, metallic dark grey and silver grey optional.
 Chromed swivels, PAR 36 pressed glass lamps, two charging levels and autotesting.



Z-4***G (GREY) or
 Z-4***D (GREY)

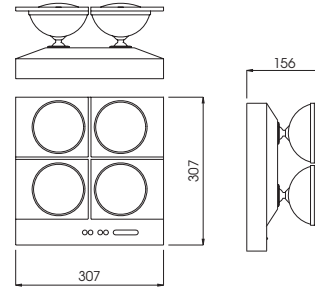

Large twin-spot Zenit: Z2G
 Housing made of PC-ASA.
 Colours: standard white, metallic dark grey and silver grey optional.
 Chromed swivels, PAR 36 pressed glass lamps, two charging levels and autotesting.



Z-2***G (GREY) or
 Z-2***D (GREY)

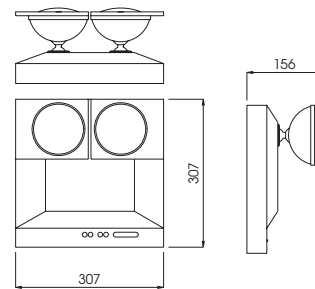

Small twin-spot Zenit: Z2P
 Housing made of PC-ASA.
 Colours: standard white, metallic dark grey and silver grey optional.
 Chromed swivels, PAR 36 pressed glass lamps, two charging levels and autotesting.



Z-2***P (GREY)

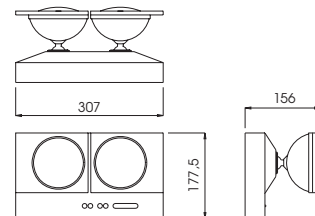

Zenit Series

It assures safety lighting in emergency situations (power failure). On account of its special installation features, lighting power and directional spots, it is suitable for large areas: Industrial Facilities, Conference Halls, Supermarkets, Meeting Rooms, etc. They have a low heat generation system for extending the useful life of the batteries.

Model	Autonomy	Lumens	Lamp	Diagram
Non maintained:				
Z-2124P	1 h	300	2 x 12 W (PAR 36)	Z2P
Z-2124G	1 h	300	2 x 12 W (PAR 36)	Z2G
Z-2127P	2 h	300	2 x 12 W (PAR 36)	Z2P
Z-2127G	2 h	300	2 x 12 W (PAR 36)	Z2G
Z-2127D	4 h	300	2 x 12 W (PAR 36)	Z2G
Z-4127G	1 h	600	4 x 12 W (PAR 36)	Z4G
Z-4127D	2 h	600	4 x 12 W (PAR 36)	Z4G
Z-2257P	1 h	425	2 x 25 W (PAR 36)	Z2P
Z-2257G	1 h	425	2 x 25 W (PAR 36)	Z2G
Z-2257D	2 h	425	2 x 25 W (PAR 36)	Z2G
Z-4257G	1 h	850	4 x 25 W (PAR 36)	Z4G

Zenit A Series Specific for Self-test

Includes microprocessor for operating in Self-test.

Non maintained:				
Z-2124P A	1 h	300	2 x 12 W (PAR 36)	Z2P
Z-2124G A	1 h	300	2 x 12 W (PAR 36)	Z2G
Z-2127P A	2 h	300	2 x 12 W (PAR 36)	Z2P
Z-2127G A	2 h	300	2 x 12 W (PAR 36)	Z2G
Z-2127D A	4 h	300	2 x 12 W (PAR 36)	Z2G
Z-4127G A	1 h	600	4 x 12 W (PAR 36)	Z4G
Z-4127D A	2 h	600	4 x 12 W (PAR 36)	Z4G
Z-2257P A	1 h	425	2 x 25 W (PAR 36)	Z2P
Z-2257G A	1 h	425	2 x 25 W (PAR 36)	Z2G
Z-2257D A	2 h	425	2 x 25 W (PAR 36)	Z2G
Z-4257G A	1 h	850	4 x 25 W (PAR 36)	Z4G

Zenit TCA Series Specific for Self-test and DaisaTest System

Includes microprocessor for operating in Self-test mode and DaisaTest centralised management System. TCA models can be supplied on request. **Check with the factory or our web site: www.daisalux.com**
TMA Test Central for ZENIT TCA. See page 16.

Finishes

Finish of:	Description	Marking
Colour	White (standard)	(RAL9003)
	Metallic dark grey small Zenit	(GREY)
	Metallic dark grey large Zenit	(GREY)
	Silver grey small Zenit	(RAL9006)
	Silver grey large Zenit	(RAL9006)
	Industrial grey	(RAL70035)

Accessories

Reference:	Description
KPG ZENIT	Accessory for installing the Zenit and Zenit PL (big model) series spotlights in surfaces irregular or inferior to l x h = 270 x 215 mm., where to install the three fixing points of the plate is not possible.
KPP ZENIT	Accessory for installing the Zenit and Zenit PL (small model) series spotlights in surfaces irregular or inferior to l x h = 150 x 215 mm., where to install the three fixing points of the plate is not possible.

Example of order:

Order for 15 emergency luminaires ZENIT, non maintained, large with 4 spots, 2 hours of autonomy in metallic dark grey colour:

15 Z-4127D (GREY)





Zenit PL Series

Construction details: Built to EN 60598-2-22 (IEC 60598-2-22) standard / Conforming to Community Electromagnetic Compatibility, Low Voltage and **RoHS** Directives 2004/108/EC, 2006/95/EC and 2002/95/EC / Built to synthetic materials, 850°C to EN 60598-1 (IEC 60598-1) and EN 60695-2-1 (IEC 60695-2-1), according to models / Battery protected against overcurrents, excessive discharges and polarity reversal / Low heat-emitting, double charging rate charger / Stand-by and emergency setting by remote control / Remote control circuit protected against faulty connection / Autonomy testing by remote control when mains voltage is present / Electric shock protection: Class II / Luminaire suitable for mounting on normally inflammable surfaces: Class "F" / **IP 42 IK 04** / Quick connection terminal / Moving limited turn swivel / Mains input thermal protector / 100% functional testing of production with computer-electronic systems.



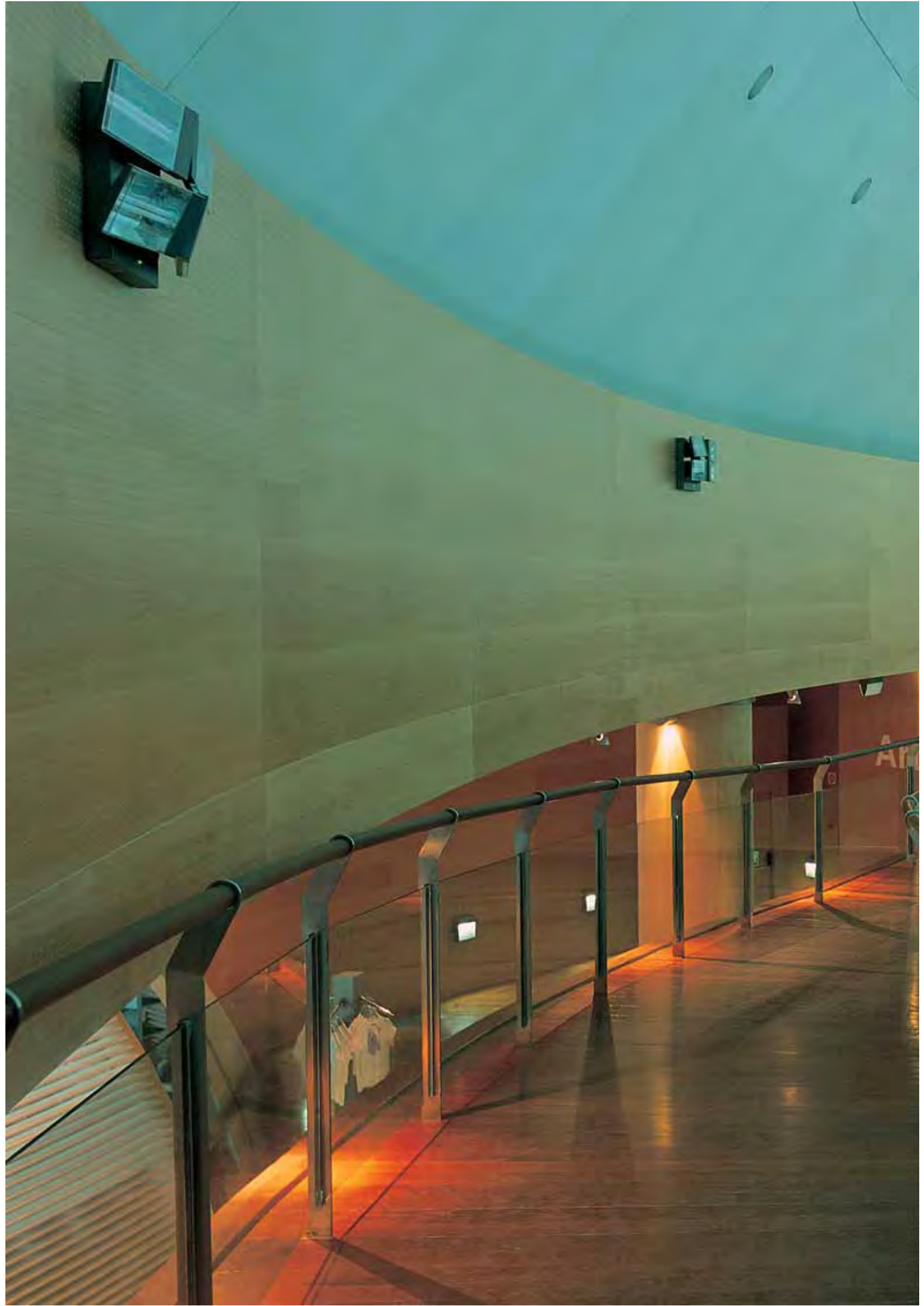



Large 4-spot Zenit PL
 Housing made of PC-ASA.
 Colours: white as standard,
 industrial grey, metallic
 grey and silver grey
 optional. Chromed swivels,
 polycarbonate diffuser,
 chromed reflector, high
 performance energy-saving
 PL lamps.

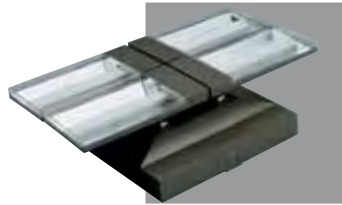

ZG4-N** (GREY)

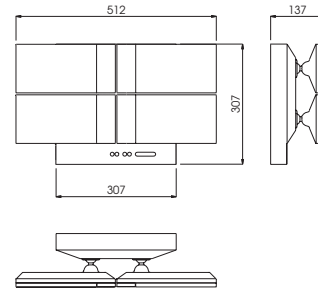

Large twin spot Zenit PL
 Housing made of PC-ASA.
 Colours: white as standard,
 industrial grey, metallic
 grey and silver grey
 optional. Chromed swivels,
 polycarbonate diffuser,
 chromed reflector, high
 performance energy-saving
 PL lamps.

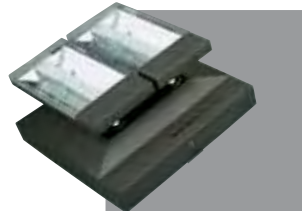

ZG2-3N** (GREY)

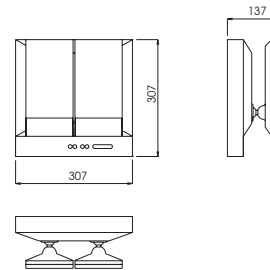

Small twin spot Zenit PL
 Housing made of PC-ASA.
 Colours: white as standard,
 industrial grey, metallic
 grey and silver grey
 optional. Chromed swivels,
 polycarbonate diffuser,
 chromed reflector, high
 performance energy-saving
 PL lamps.

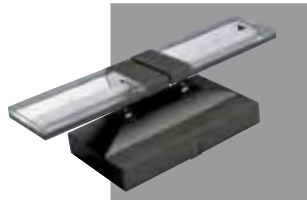

ZP2-N24** (GREY)

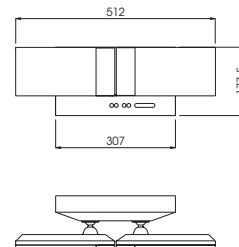

Zenit PL Series

It assures safety lighting in emergency situations (power failure). On account of its special installation features, lighting power and directional spots, it is suitable for large areas: Industrial Facilities, Conference Halls, Supermarkets, Meeting Rooms, etc. They have a low heat generation system for extending the useful life of the batteries.

Model	Autonomy	Lumens	Lamp
Non maintained:			
ZP2-N24 (1)	1 h	1.125	2 x PL 11 W
ZG4-N26	1 h	1.175	4 x PL 11 W
ZG4-N48	1 h	2.300	4 x PL 11 W
ZG2-2N26	2 h	1.200	2 x PL 11 W
ZG2-3N11	3 h	400	2 x PL 11 W
ZG2-3N14	3 h	850	2 x PL 11 W

Zenit PL A Series Specific for Self-test

Includes microprocessor for operating in Self-test.

Model	Autonomy	Lumens	Lamp
Non maintained:			
ZP2-N22 A (1)	1 h	1.100	2 x PL 11 W
ZG4-N22 A	1 h	1.212	4 x PL 11 W
ZG4-N44 A	1 h	2.200	4 x PL 11 W
ZG2-2N24 A	2 h	1.100	2 x PL 11 W
ZG2-3N8 A	3 h	424	2 x PL 11 W
ZG2-3N12 A	3 h	740	2 x PL 11 W

Zenit PL TCA Series Specific for Self-test and DaisaTest System

Includes microprocessor for operating in Self-test mode and DaisaTest centralised management System. TCA models can be supplied on request. **Check with the factory or our web site: www.daisalux.com**
TMA Test Central for ZENIT PL TCA. See page 16.

Finishes

Finish of: Colour	Description	Marking
	White (standard)	-----
	Metallic dark grey small Zenit	(GREY)
	Metallic dark grey large Zenit	(GREY)
	Silver grey small Zenit	(RAL9006)
	Silver grey large Zenit	(RAL9006)

Accessories

Reference:	Description
KPG ZENIT	Accessory for installing the Zenit and Zenit PL (big model) series spotlights in surfaces irregular or inferior to lxh= 270 x 215 mm., where to install the three fixing points of the plate is not possible.
KPP ZENIT	Accessory for installing the Zenit and Zenit PL (small model) series spotlights in surfaces irregular or inferior to lxh= 150 x 215 mm., where to install the three fixing points of the plate is not possible.

Example of order:

Order for 10 emergency spotlights ZENIT PL, non maintained, large, twin-spot, 3 hours of autonomy in silver grey colour:

10 ZG2-3N11 (RAL9006)

Operation, Common Data and Notes

(1) The small model reference is: ZP2-N22 TCA and ZP2-N24.

Photometric curves

Large Zenit PL with 4 spots

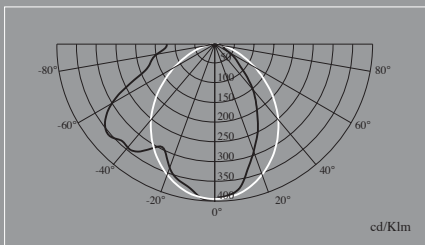

Large Zenit PL with 2 spots
Small Zenit PL with 2 spots

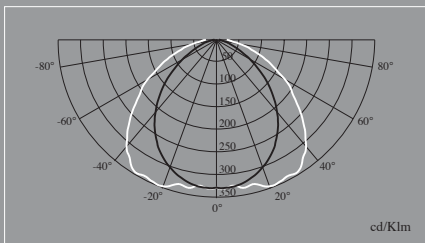

— Horizontal cut-off — Vertical cut-off



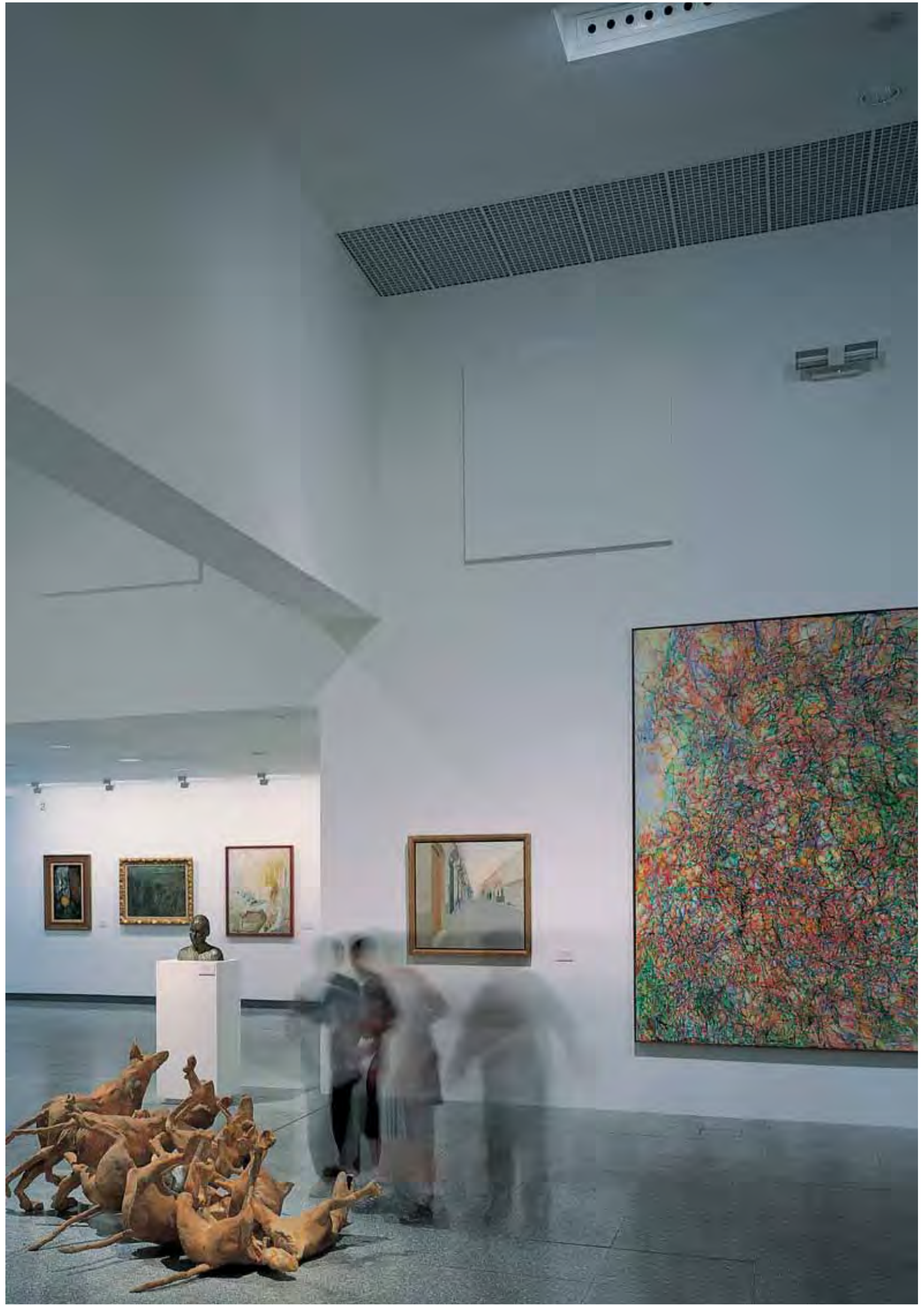

Vir Series

Construction details: Built to EN 60598-1 (IEC 60598-1) standard / Conforming to Community Electromagnetic Compatibility, Low Voltage and **RoHS** Directives 2004/108/EC, 2006/95/EC and 2002/95/EC / **IP 42 IK 03** / Luminaire electric shock protection: Class III / Luminaire suitable for being mounted on normally inflammable surfaces: Class "F" / "No Power Supply Module" models: Power supply 12V AC/DC Consumption <500 mA / "Maintained" and "Luminaire" models (Includes power supply module): Supply voltage: 230V, 50Hz. Consumption <500 mA / "Maintained" models: Battery protected against excessive discharges and polarity reversal. Stand-by setting by remote control. Provides autonomy of 1 hour when mains voltage is absent. Battery charging time, 24 hours / Light source by LED technology.



Ceiling Sign Vir



VIR-T

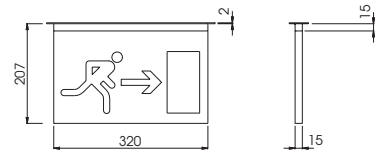

Flat Wall Sign Vir



VIR-P

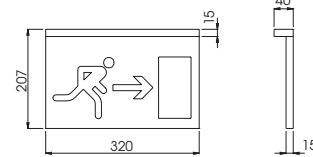

Left-hand pennant Wall Sign Vir



VIR-BI

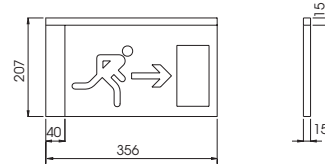

Right-hand pennant Wall Sign Vir



VIR-BD

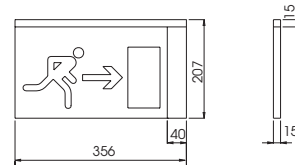

Suspended Wall Sign Vir



VIR-S

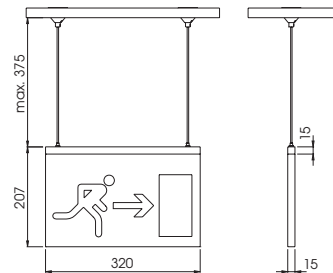

Power supply module for presence of mains voltage

Transformer: 230V AC input, 12V AC output

It may be installed on a symmetric DIN 46277/3 track in the system thermal magnetic breaker box, occupying a width of 2,5 thermal magnetic breakers.

Permanent power supply module with batteries

Each unit can provide a luminaire with an uninterrupted supply (either when mains voltage is present or absent). It enables the luminaire to be switched on and off by means of a button or from a distance by remote control. It may be fitted on a symmetric DIN 46277/3 track. The width of the unit is equivalent to that of 12 standard thermal magnetic breakers (215 mm.).

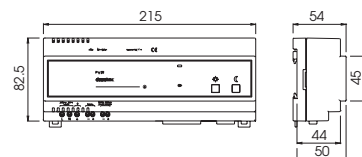
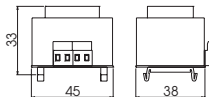

Vir Series

Simple, compact, transparent, made in acrylic material with an aluminium frame and the latest LED technology, it provides consistent, long-lasting lighting and offers a definitive solution for permanent signposting. It provides an uninterrupted visual sequence through its highly discreet symbols.

Model	Assembly	Power supply
Permanent: The "Permanent" models include a permanent power supply module with batteries. Battery range of 1 hour or three hours.		
VIR-T P	Ceiling sign	230V
VIR-P P	Flat wall sign	230V
VIR-BI P (1)	Left-hand protruding wall sign	230V
VIR-BD P (1)	Right-hand protruding wall sign	230V
VIR-S P	Hanging sign	230V
VIR-T 3 P	Ceiling sign	230V
VIR-P 3 P	Flat wall sign	230V
VIR-BI 3 P (1)	Left-hand protruding wall sign	230V
VIR-BD 3 P (1)	Right-hand protruding wall sign	230V
VIR-S 3 P	Hanging sign	230V
Permanent TCA: The "Permanent TCA" models include microprocessor for operating in self-test mode and DaisaTest centralised management System. Battery range of 1 hour or three hours.		
VIR-T P TCA	Ceiling sign	230V
VIR-P P TCA	Flat wall sign	230V
VIR-BI P TCA (1)	Left-hand protruding wall sign	230V
VIR-BD P TCA (1)	Right-hand protruding wall sign	230V
VIR-S P TCA	Hanging sign	230V
VIR-T 3 P TCA	Ceiling sign	230V
VIR-P 3 P TCA	Flat wall sign	230V
VIR-BI 3 P TCA (1)	Left-hand protruding wall sign	230V
VIR-BD 3 P TCA (1)	Right-hand protruding wall sign	230V
VIR-S 3 P TCA	Hanging sign	230V
Luminary: The "Luminary" models include a power supply module for mains connection.		
VIR-T L	Ceiling sign	230V
VIR-P L	Flat wall sign	230V
VIR-BI L (1)	Left-hand protruding wall sign	230V
VIR-BD L (1)	Right-hand protruding wall sign	230V
VIR-S L	Hanging sign	230V
No power supply module: The "No power supply module" models require a PBL unit.		
VIR-T S	Ceiling sign	24V AC/DC (1=0,18A)
VIR-P S	Flat wall sign	24V AC/DC (1=0,18A)
VIR-BI S (1)	Left-hand protruding wall sign	24V AC/DC (1=0,18A)
VIR-BD S (1)	Right-hand protruding wall sign	24V AC/DC (1=0,18A)
VIR-S S	Hanging sign	24V AC/DC (1=0,18A)
No lighting: The "No lighting" models have no mains connection.		
VIR-T N	Ceiling sign	----
VIR-P N	Flat wall sign	----
VIR-BI N (1)	Left-hand protruding wall sign	----
VIR-BD N (1)	Right-hand protruding wall sign	----
VIR-S N	Hanging sign	----

Finishes

Finish of:	Description	Marking
Standard signs (V-grooved edges) (2)	See next page	(RT...)
Special signs (no V-grooved edges)	Tailor-made signs to order without V-grooved edges.	----
Special signs (V-grooved edges) (2)	Tailor-made signs to order with V-grooved edges.	----
Photoluminescent signs	All the photoluminescent signs are supplied for models without lighting	(RTF09XX)

Maximum quantities of VIR model without power supply module at 24V, powered by the various centralised units:

	Range of 1 hour VIR-* S	Range of 2 hours VIR-* S	Range of 3 hours VIR-* S
PBL-80	6	3	2
PBL-80 (NI-MH)	6	3	2
PBL-60 TCA	5	2	1
PBL-60 TCA (NI-MH)	5	2	1
PBL 25	2	1	-

Example of order:

Order for 50 VIR series suspended model luminaires, with maintained lighting and exit sign:

50 VIR-S P (RT0900)

Operation, Common Data and Notes

(1) Protruding VIR-BI models must be wall-mounted on the left.

Protruding VIR-BD models must be wall-mounted on the right.

(2) The V-grooved edges of the main outline of the drawing lets the light through said areas to highlight the identification of the image.

For different sizes of the Vir series models shown in this catalogue, please check with the factory.

Signs

RT0901



RT0902



RT0904



RT0905



RT0906



RT0908



RT0914



RT0915



RT0916



RT0910



RT0911



RT0912



RT0913



NOTE: Other signs may be supplied to order



Lyra Series

Construction details: Built to EN 60598-1 (IEC 60598-1) standard / Conforming to Community Electromagnetic Compatibility, Low Voltage and **RoHS** Directives 2004/108/EC, 2006/95/EC and 2002/95/EC / Built to synthetic materials, 850°C to EN 60598-1 (IEC 60598-1) and EN 60695-2-1 (IEC 60695-2-1), according to models.

Supply voltage: 230V AC and 24V DC / Signage: when mains voltage is present or absent by means of centralized PBL-80 and PBL-25 units / Class II luminaire / System of anchorage by means of clamps / No maintenance required / **IP 62 IK 07**.



Life-size photo

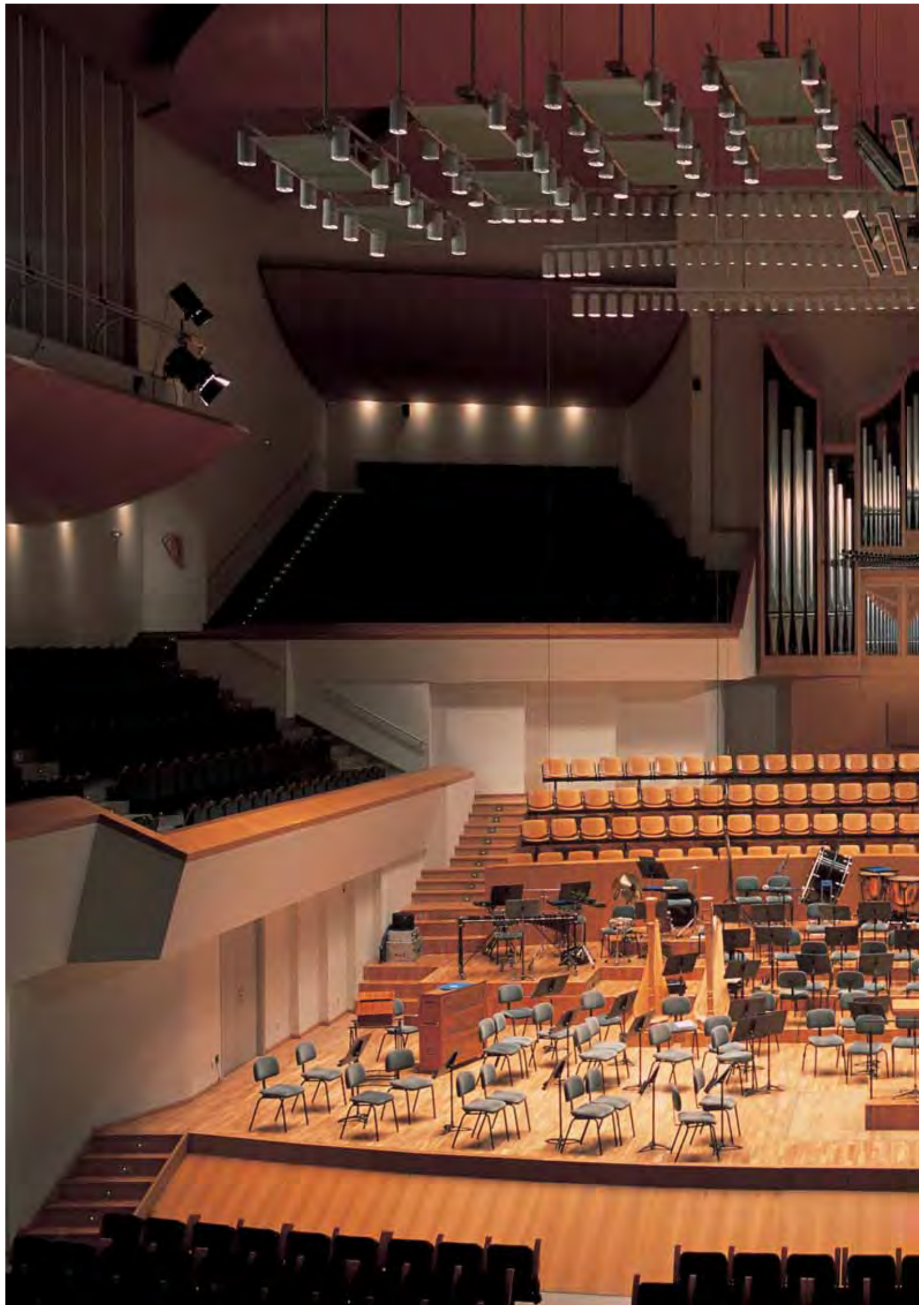

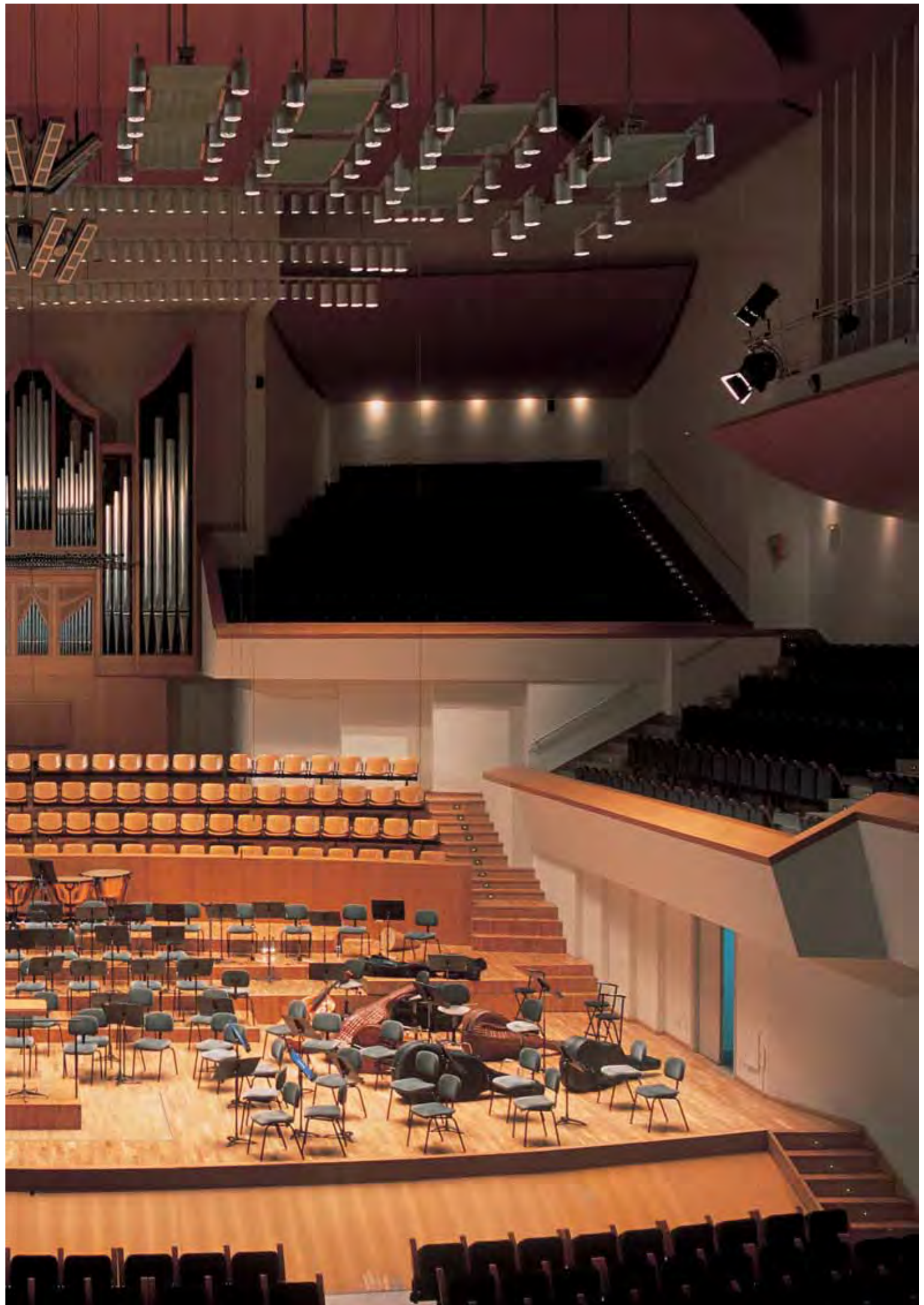

Finishes:

Colour: White LED
 Diffuser: Opal
 Trim: Gold



Box installation

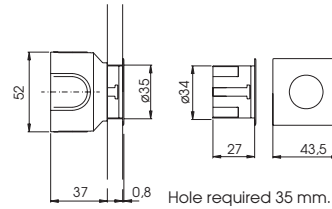

Finishes:

Colour: Blue LED
 Diffuser: Opal
 Trim: Inox

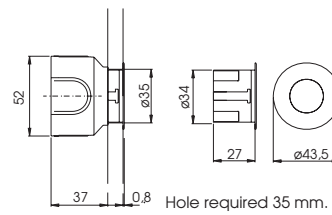

Finishes:

Colour: Red LED
 Diffuser: Opal
 Trim: Nickel



Box mounting with
 KPC LYRA positioner

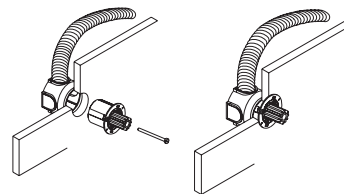

Finishes:

Colour: Green LED
 Diffuser: Transparent
 Trim: Graphite



Installation without box

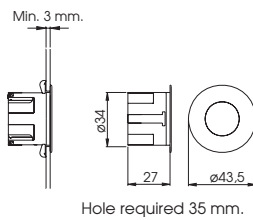

Finishes:

Colour: Amber LED
 Diffuser: Transparent
 Trim: Bright Chrome



Finishes:

Option of customizable
 opal diffuser
 available in all
 finishes

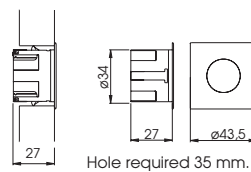

Lyra Series

Small-sized, practically flat beacon, suitable for mounting on any material. Application of leading edge LED technology, its different finishes by way of its external stainless steel ring, and the two transparent and opal finishes of the diffuser make it particularly suitable for signage both when mains voltage is absent and present. A new binomial has come to life, integrated in the same beacon; emergency beaconing and lighting, as a solution with a functional appearance for the most creative architecture.

Model	LEDs Colour	
Round Lyra		
LYRA R/B	White	
LYRA R/Z	Blue	
LYRA R/V	Green	
LYRA R/A	Amber	
LYRA R/R	Red	
Square Lyra		
LYRA C/B	White	
LYRA C/Z	Blue	
LYRA C/V	Green	
LYRA C/A	Amber	
LYRA C/R	Red	
Finishes		
Finish of:	Description	Marking
Colour	Inox	(INOX)
	Graphite	(GRAPHITE)
	Matt Chrome	(CHROME-M)
	Bright Chrome	(CHROME-B)
	Nickel	(NICKEL)
	Gold	(GOLD)
Diffuser	Transparent	(TR)
	Opal	(OPAL)
	Customised opal diffuser	(OPAL-P)
Voltage	230V, 50Hz	(230V)
	24V DC/AC (I=0,030A) (can be supplied with PBL units).	(24V)
Accessories		
Reference	Description	
KE LYRA (1)	Recessed housing box.	
KPC LYRA	Positioner for installing the Lyra recessing box on surfaces such as marble, wood, tile, forms, concrete, etc...	
Power supply devices		
PBL-80	Battery-powered unit with a constant output at 24V, 1.20 A. Includes Ni-Cd battery. Battery range of 1 hour. Has two power levels, one of which can be adjusted when connected to the mains. Operation in Self-test mode. (for further information, see page 152 and 153)	
PBL-80 (NI-MH)	Battery-powered unit with a constant output at 24V, 1.20 A. Includes NI-MH battery. Battery range of 1 hour. Has two power levels, one of which can be adjusted when connected to the mains. Operation in Self-test mode. (for further information, see page 152 and 153)	
PBL-25	Battery-powered unit with a constant output at 24V, 0.38 A. Includes Ni-Cd battery. Battery range of 1 hour. (for further information, see page 152 and 153)	
PBL-60 TCA	Battery-powered unit with a constant output at 24V, 0.90 A. Includes Ni-Cd battery. Battery range of 1 hour. Has two power levels, one of which can be adjusted when connected to the mains. Includes microprocessor for operation with the DaisaTest Centralised System. (for further information, see page 152 and 153)	
PBL-60 TCA (NI-MH)	Battery-powered unit with a constant output at 24V, 0.90 A. Includes NI-MH battery. Battery range of 1 hour. Has two power levels, one of which can be adjusted when connected to the mains. Includes microprocessor for operation with the DaisaTest Centralised System. (for further information, see page 152 and 153)	
TL-40	Transformer for supplying a maximum of 40 LYRA beacons (24V)	
DIR-1	Directional switch powered at 24V AC-DC that enables one out of every four LYRA (24V) beacons in a system to be switched on sequentially to indicate a direction.	

Example of order:

Order for 100 LYRA beacons, round, white led, bright chrome finish, opal diffuser, supplied at 230V:
100 LYRA R/B (CHROME-BRIGHT, OPAL, 230V)

Operation, Common Data and Notes:

All references must be accompanied by the MARKING column indication:

- Colour: inox (INOX), graphite (GRAPHITE), ...
- Diffuser: Transparent (TR), Opal (OPAL) or Customised opal diffuser (OPAL-P).
- Voltage: 230V, 50 Hz (230V) or 24V DC/CA (24V)

(1) LYRA beacon is dispatched with a recessing box (standard).



EXIT



Salida
Eixida
Exit

PRECAUCION
Tomen las escaleras lentamente
PRECAUCION
Tomez as escadarias lentamente
CAUTION
Ascend and descend slowly



Aqua Series

Construction details: Built to EN 60598-1 (IEC 60598-1) standard / Conforming to Community Electromagnetic Compatibility, Low Voltage and **RoHS** Directives 2004/108/EC, 2006/95/EC and 2002/95/EC / Built to synthetic materials, 850°C to EN 60598-1 (IEC 60598-1) and EN 60695-2-1 (IEC 60695-2-1), according to models.

Supply voltage: 230V AC and 24V DC / Class II luminaire/ Signing: when mains voltage is present or absent by means of centralized PBL-80 and PBL-25 units / Packing gland Pg9 for sleeved cable of a diameter between 5.5 mm – 7.4 mm / Anchorage system by means of clamps / No maintenance required / **IP 66 IK 07**.



Life-size photo

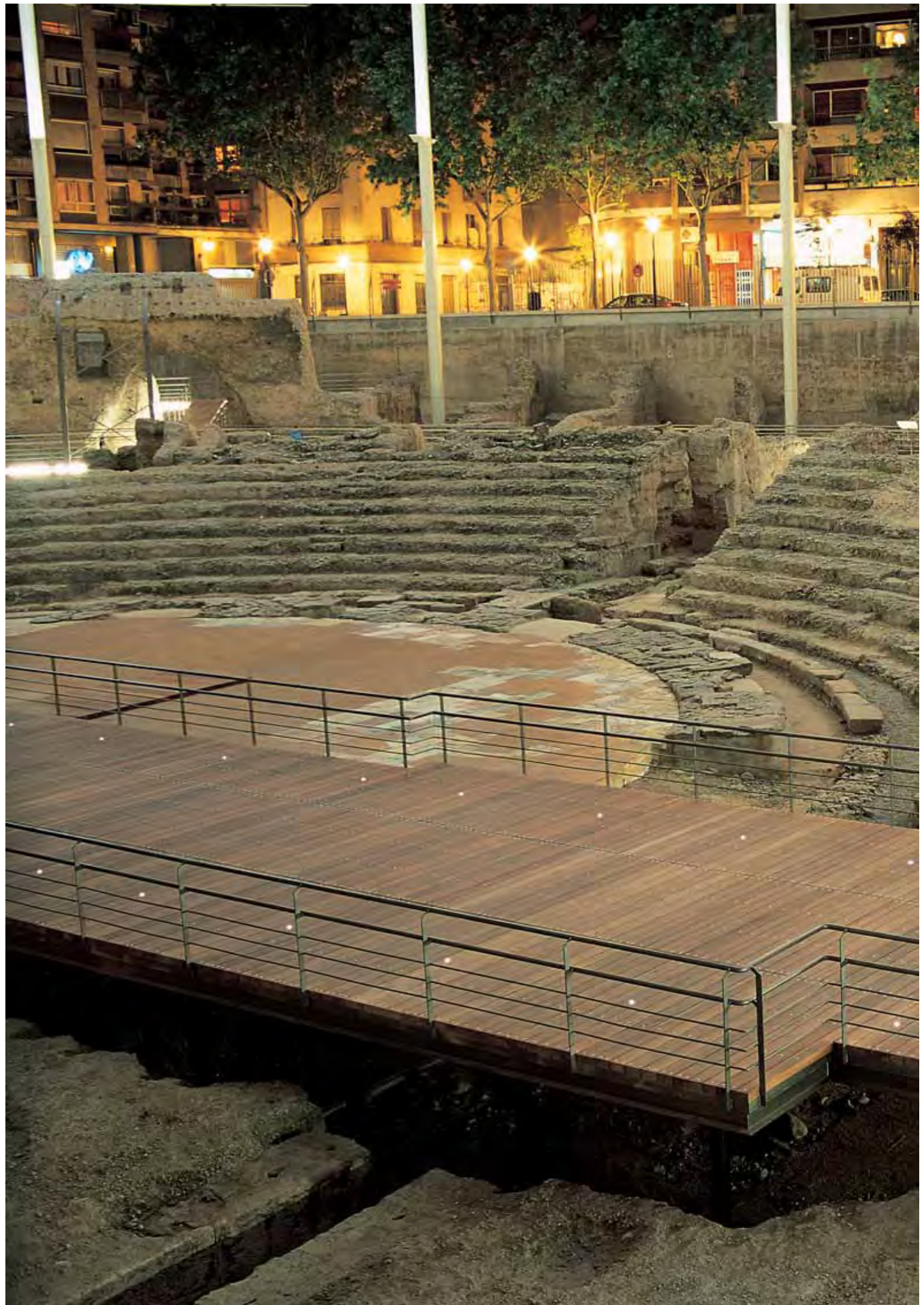

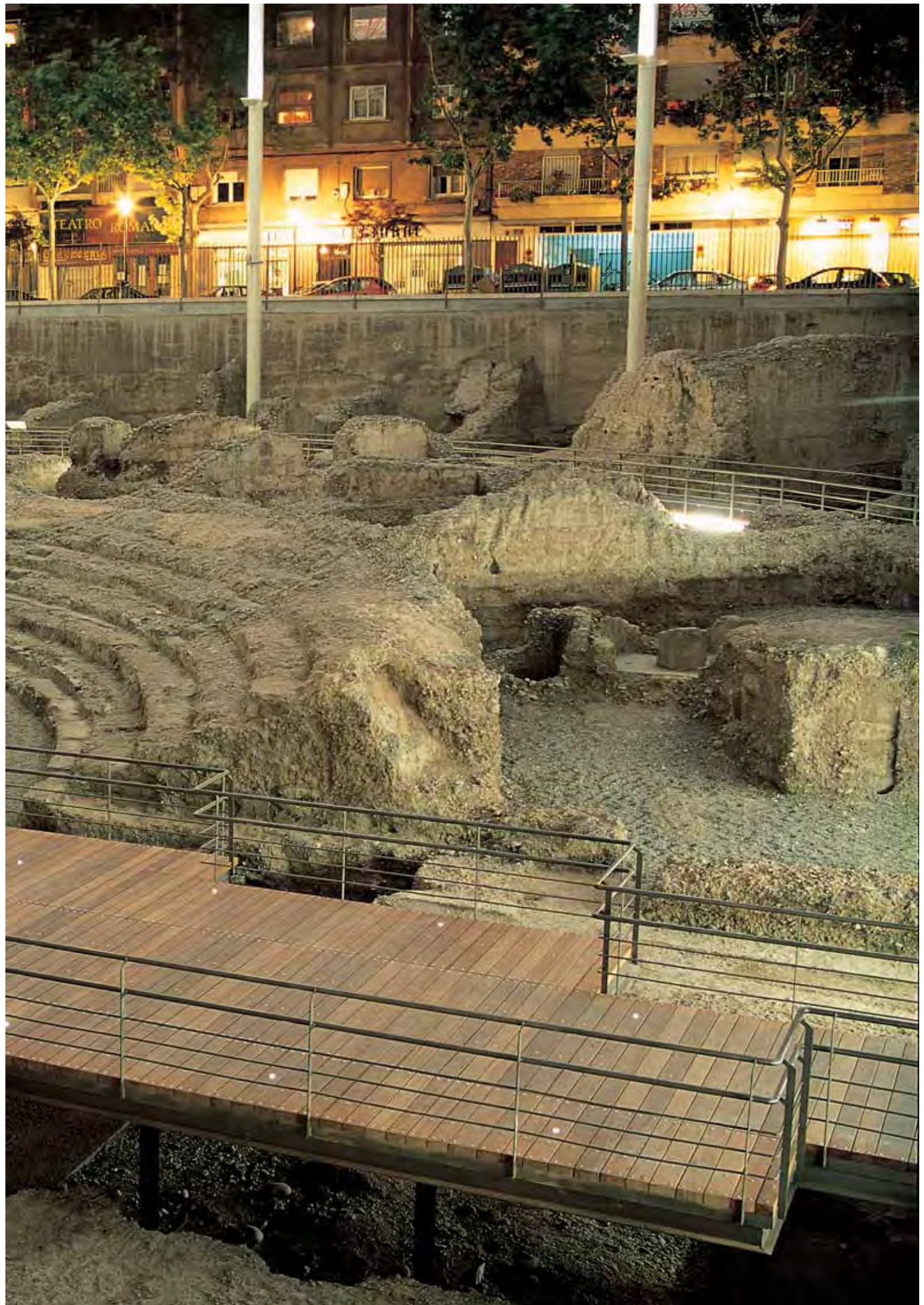

Round trim made of stainless steel.
LED colour: white.



Installation with box

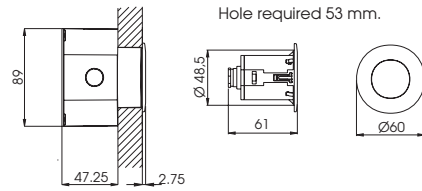

Square trim made of stainless steel.
LED colour: blue.



Round trim made of stainless steel.
LED colour: red.

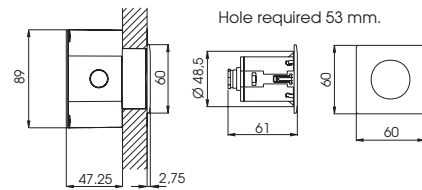

Square trim made of stainless steel.
LED colour: green.



Installation without box

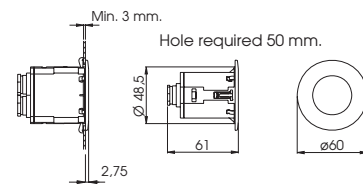

Round trim made of stainless steel.
LED colour: amber.

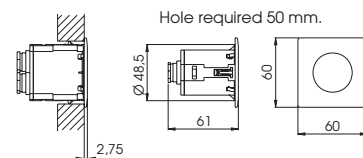

Finishes:
Option of customizable
opal diffuser
available in all
finishes



Aqua Series

Courtesy beacon specially designed for covering outdoor signing applications on account of its IP 66 IK 07. For flush fitting in walls and floors, it may be installed with or without a recess box. Its light source consists of a set of LEDs that provide uniform diffuser lighting and a long maintenance-free life.

Model	LED Colour	
Round Aqua		
AQUA R/B	White	
AQUA R/Z	Blue	
AQUA R/V	Green	
AQUA R/A	Amber	
AQUA R/R	Red	
Square Aqua		
AQUA C/B	White	
AQUA C/Z	Blue	
AQUA C/V	Green	
AQUA C/A	Amber	
AQUA C/R	Red	
Finishes		
Finish of:	Description	Marking
Voltage	230V, 50 Hz 24V DC/AC (I=0,030A) (can be supplied with PBL units).	(230V) (24V)
Diffuser	Opal (standard) Customised opal diffuser (black or colour) (1)	(OPAL) (OPAL-P)
Accessories		
Reference	Description	
KE AQUA (2)	Recessed housing box	
Power supply devices		
PBL-80	Battery-powered unit with a constant output at 24V, 1.20 A. Includes Ni-Cd battery. Battery range of 1 hour. Has two power levels, one of which can be adjusted when connected to the mains. Operation in Self-test mode. (for further information, see pages 152 and 153)	
PBL-80 (NI-MH)	Battery-powered unit with a constant output at 24V, 1.20 A. Includes NI-MH battery. Battery range of 1 hour. Has two power levels, one of which can be adjusted when connected to the mains. Operation in Self-test mode. (for further information, see pages 152 and 153)	
PBL-25	Battery-powered unit with a constant output at 24V, 0.38 A. Includes Ni-Cd battery. Battery range of 1 hour. (for further information, see pages 152 and 153)	
PBL-60 TCA	Battery-powered unit with a constant output at 24V, 0.90 A. Includes Ni-Cd battery. Battery range of 1 hour. Has two power levels, one of which can be adjusted when connected to the mains. Includes microprocessor for operation with the DaisaTest Centralised System. (for further information, see pages 152 and 153)	
PBL-60 TCA (NI-MH)	Battery-powered unit with a constant output at 24V, 0.90 A. Includes NI-MH battery. Battery range of 1 hour. Has two power levels, one of which can be adjusted when connected to the mains. Includes microprocessor for operation with the DaisaTest Centralised System. (for further information, see pages 152 and 153)	
TL-40	Transformer for supplying a maximum of 20 AQUA beacons (24V)	
DIR-1	Directional switch that enables one out of every four AQUA (24V) beacons in a system to be switched on sequentially to indicate a direction.	

Example of order:

Order for 40 round AQUA beacons, with white LEDs to power with 24V +1 PBL-80:

40 AQUA R/B (24V)
1 PBL-80

Operation, Common Data and Notes

(1) In order to personalise the diffuser, please send a design in vector format: export@daisalux.com indicating the reference of the order.

All references must be accompanied by the MARKING column indication:

- Voltage: 230V, 50 Hz (230V) or 24V DC/AC (24V)

- Diffuser: Opal standard (OPAL), Customised opal diffuser (OPAL-P).

(2) AQUA beacon is dispatched with a recessing box (standard).

Not suitable for immersion





**PBL units for supplying beacon models:
(LYRA-AQUA)**

PBL-60
PBL-80

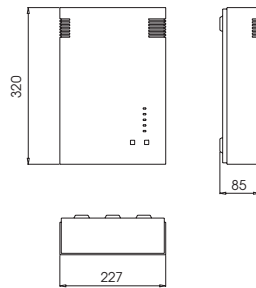

PBL-25

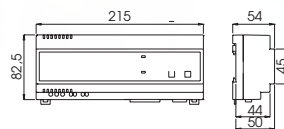

PBL Units

Centralized PBL-25 and PBL-80 supply Daisalux Lyra (24V) and Aqua (24V) beacons. They can supply as many as 25 and 80 beacons, respectively, without interruption (with or without mains voltage). The PBL-25 enables the beacon system to be switched on and off by hand or remotely by means of a remote control. The PBL-80 offers the possibility both of having different levels of lighting in the same beacon system and of running system operating tests. These tests may be carried out automatically (autotest) and they may also be activated manually with a button.

Model	Description
Power supply devices:	
PBL-80	Battery-powered unit with a constant output at 24V, 1.20 A. Includes Ni-Cd battery. Battery range of 1 hour. Has two power levels, one of which can be adjusted when connected to the mains. Operation in Self-test mode.
PBL-80 (NI-MH)	Battery-powered unit with a constant output at 24V, 1.20 A. Includes NI-MH battery. Battery range of 1 hour. Has two power levels, one of which can be adjusted when connected to the mains. Operation in Self-test mode.
PBL-25	Battery-powered unit with a constant output at 24V, 0.38 A. Includes Ni-Cd battery. Battery range of 1 hour.
PBL-60 TCA	Battery-powered unit with a constant output at 24V, 0.90 A. Includes Ni-Cd battery. Battery range of 1 hour. Has two power levels, one of which can be adjusted when connected to the mains. Includes microprocessor for operation with the DaisaTest Centralised System.
PBL-60 TCA (NI-MH)	Battery-powered unit with a constant output at 24V, 0.90 A. Includes NI-MH battery. Battery range of 1 hour. Has two power levels, one of which can be adjusted when connected to the mains. Includes microprocessor for operation with the DaisaTest Centralised System.
Maximum amount of the LYRA and AQUA (24V) series powered by the various centralised battery supply units.	
Power supply devices	LYRA (24V) AQUA (24V)
PBL-80	80 40
PBL-80 (NI-MH)	80 40
PBL-60 TCA	60 30
PBL-60 TCA (NI-MH)	60 30
PBL-25	25 12

Measurements:

(See Dimension Chart on previous page)

Construction details: Unit suitable for complying with EN 50171 (IEC 50171): Centralized power supply systems / Conforming to Community Electromagnetic Compatibility, Low Voltage and RoHS Directives 2004/108/EC, 2006/95/EC and 2002/95/EC / Metal housing treated with epoxy powder paint / High temperature sealed rechargeable Ni-Cd batteries to EN 285 (IEC 285) / Battery charging warning LED / Electric shock protection: Class I / **IP 20 IK 04** / 100% functional testing of production with computer-electronic systems.

Sherpa Series

Construction details: Built to EN 60598-1 (IEC 60598-1) standard / Conforming to Community Electromagnetic Compatibility, Low Voltage and **RoHS** Directives 2004/108/EC, 2006/95/EC and 2002/95/EC / Standby setting by remote control / Remote control circuit protected against faulty connection / **IP 42 IK 07** / Centralized autonomy operation and luminaire / 100% functional production testing with computer-electronic systems.



Life-size photo

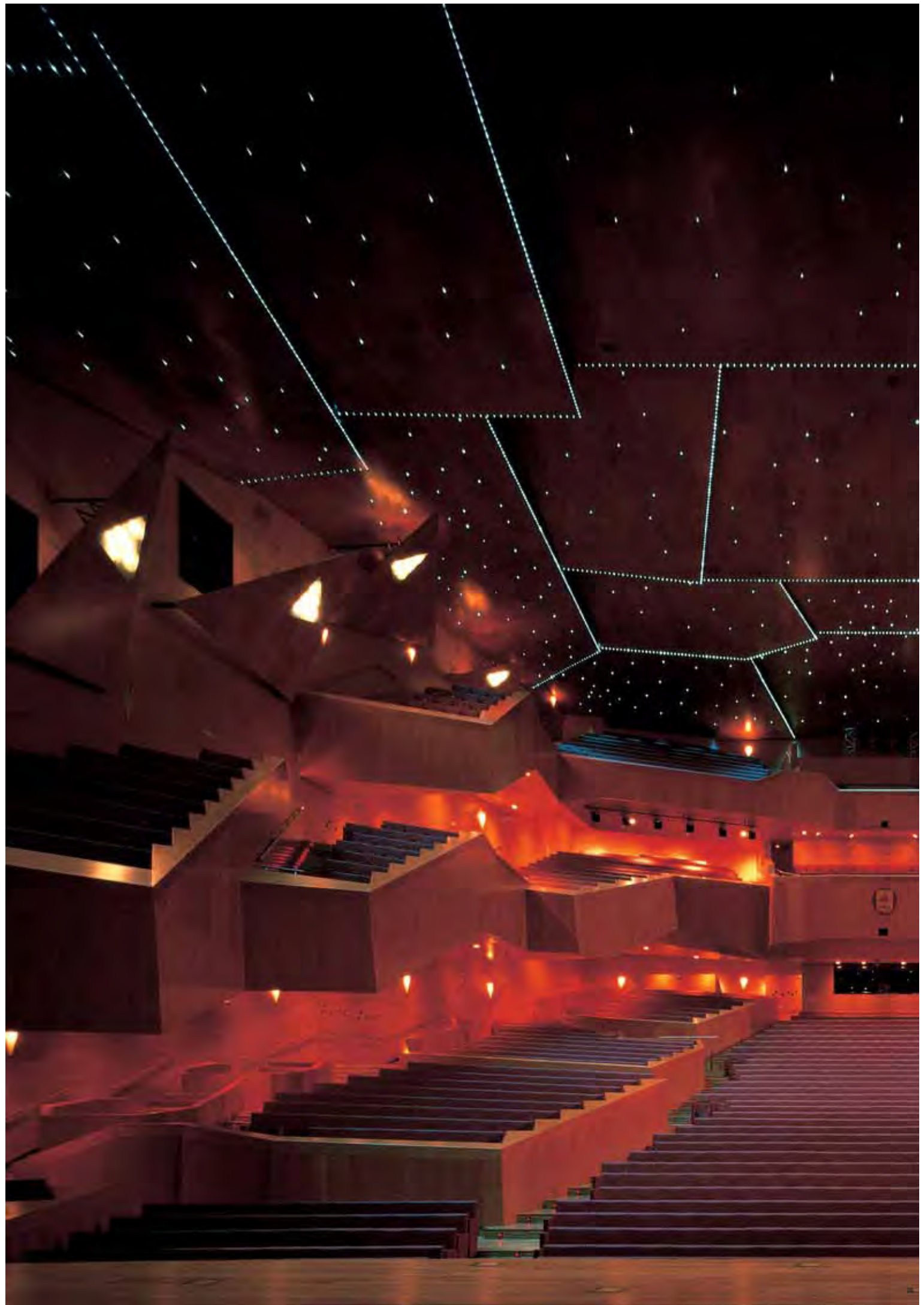

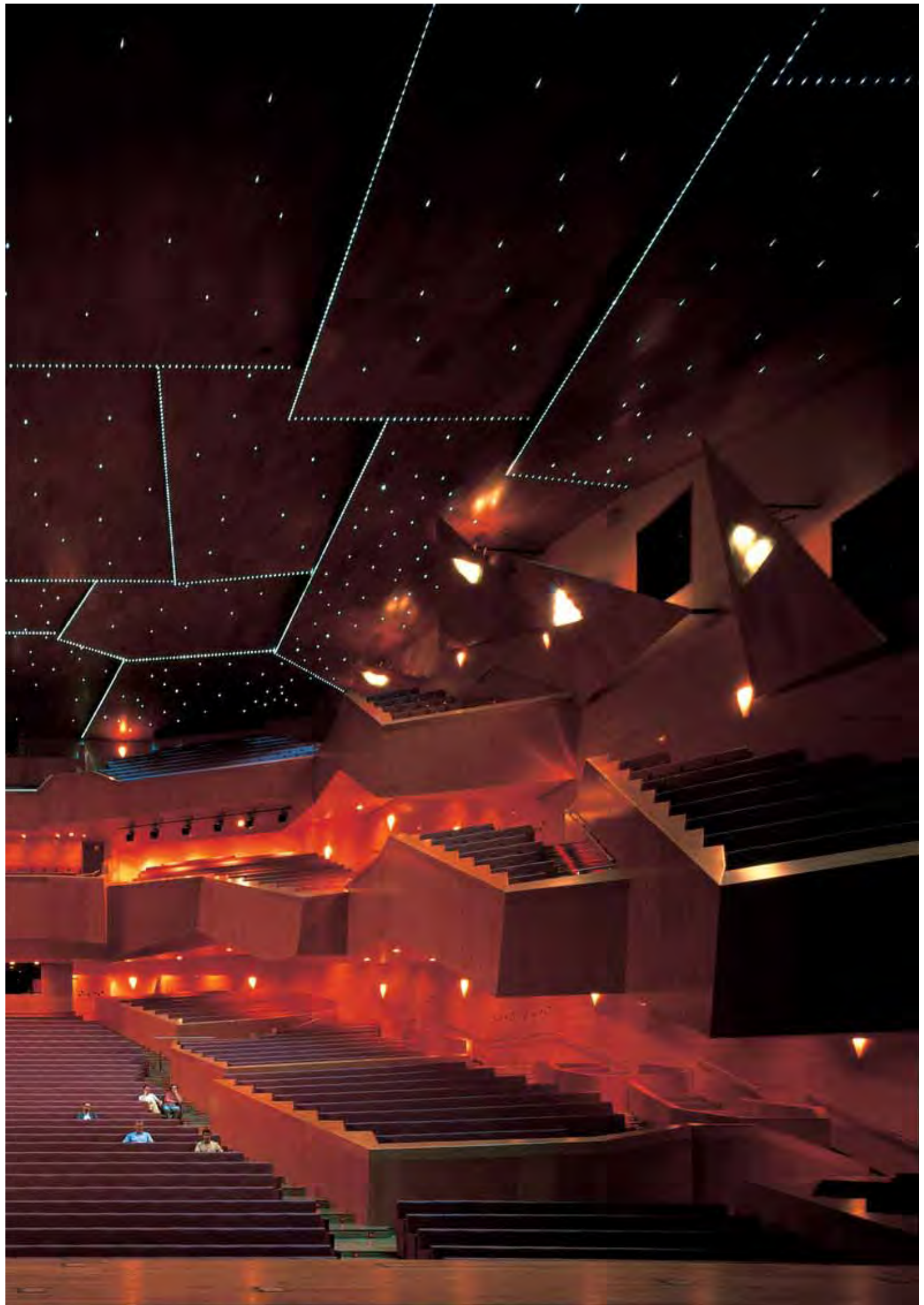

Sherpa RC

Trim made of Zamak, with grey Nextel finishes as standard. White epoxy powder paint. Electrolytic bath or with optional chrome, nickel, gold or graphite finishes optional. Polycarbonate diffuser and ABS or polycarbonate reflector.

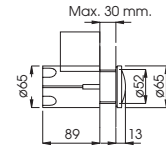

Hole required ø 52 mm.

Sherpa CC

Trim and frame made of Zamak, with grey Nextel finishes as standard. White epoxy powder paint. Electrolytic bath or with optional chrome, nickel, gold or graphite finishes optional. Polycarbonate diffuser and ABS or polycarbonate reflector.

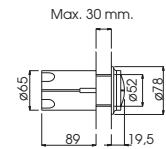

Hole required ø 52 mm.

Sherpa RS

Trim made of Zamak, with grey Nextel finishes as standard. White epoxy powder paint. Electrolytic bath or with optional chrome, nickel, gold or graphite finishes optional. Polycarbonate diffuser and ABS or polycarbonate reflector.

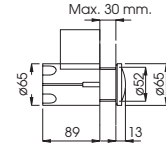

Hole required ø 52 mm.

Sherpa CS

Trim and frame made of Zamak, with grey Nextel finishes as standard. White epoxy powder paint. Electrolytic bath or with optional chrome, nickel, gold or graphite finishes optional. Polycarbonate diffuser and ABS or polycarbonate reflector.

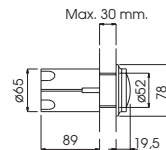

Hole required ø 52 mm.

Universal box for centralized and courtesy beacon

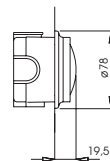

Sherpa Series

The embryo of the entire range of Daisalux beacons. Its operation as a centralized or self-contained beacon, its square or rounded forms, the diffusers with or without a visor, its different finishes, its functions as either a courtesy or emergency beacon, in short, a new spectrum of possibilities as a response to a Daisalux rationalisation process in order to meet beaconing needs.

Model	Autonomy	Voltage	Emerg. lamp	Charging monitor
SHERPA/A Series (Self-contained)				
SHERPA/A RC	1 h	230V 50Hz	2,5V - 0,3A	LED*
SHERPA/A RS	1 h	230V 50Hz	2,5V - 0,3A	LED*
SHERPA/A CC	1 h	230V 50Hz	2,5V - 0,3A	LED*
SHERPA/A CS	1 h	230V 50Hz	2,5V - 0,3A	LED*

* Finishes for LED colour.

Finishes

Finish of:	Description	Marking	
LED colour	Red	(L-RED)	
	White	(L-WHITE)	
	Blue	(L-BLUE)	
	Green	(L-GREEN)	
	Amber	(L-AMBER)	
Colour or bath	NEXTEL GREY (standard)	----	
	PAINTED WHITE	(WHITE)	
	GOLD	Mod: -RC and -RS	(WHITE)
		Mod: -CC and -CS	(GOLD)
	CHROMED	Mod: -RC and -RS	(GOLD)
		Mod: -CC and -CS	(CHROME)
	GRAPHITE	Mod: -RC and -RS	(CHROME)
		Mod: -CC and -CS	(GRAPHITE)
	NICKEL-PLATED	Mod: -RC and -RS	(GRAPHITE)
		Mod: -CC and -CS	(NICKEL)

Example of order:

Order for 100 self-contained, round SHERPA beacons, model without visor, white LED, golden colour:
100 SHERPA/A RS (L-WHITE) (GOLD)

Operation, Common data and notes (SHERPA/A)

The letters following the SHERPA/A models mean:

First letter: **R**: round **C**: square

Second letter: **C**: with visor **S**: without visor

OPERATION: Beacons light up 2 leds when mains voltage is present (see finishes). A 1,2W incandescent lamp lights up when mains voltage is absent.

The SHERPA/A model includes recessing box as standard and positioning piece.

Protection class: **IP 42 IK 07.**

Model	Voltage	Lamp
SHERPA/D Series (courtesy lighting)		
SHERPA/D RC	SEE FINISHES	Incandescent
SHERPA/D RS	SEE FINISHES	Incandescent
SHERPA/D CC (1)	SEE FINISHES	Incandescent
SHERPA/D CS (1)	SEE FINISHES	Incandescent

Finishes

Finish of:	Description	Marking	
Voltage	12V AC/DC (2)	(12V)	
	24V AC/DC (2)	(24V)	
	230V, 50Hz (2)	(230V)	
Colour or bath	NEXTEL GREY (standard)	----	
	PAINTED WHITE	(WHITE)	
	GOLD	Mod: -RC and -RS	(WHITE)
		Mod: -CC and -CS	(GOLD)
	CHROMED	Mod: -RC and -RS	(GOLD)
		Mod: -CC and -CS	(CHROME)
	GRAPHITE	Mod: -RC and -RS	(CHROME)
		Mod: -CC and -CS	(GRAPHITE)
	NICKEL-PLATED	Mod: -RC and -RS	(GRAPHITE)
		Mod: -CC and -CS	(NICKEL)

Accessories

Reference:	Description
KE SHERPA	Recessing box Sherpa

Example of order:

Order for 100 SHERPA for lighting up when mains voltage is present, round, without visor, in gold colour at 24V AC-DC:
100 SHERPA/D RS (24V) (GOLD)

Operation, Common Data and Notes (SHERPA/D)

(1) Can be installed in a universal junction box.

(2) **OPERATION:** for 12V AC/DC. and 24V AC/DC voltages a 2W incandescent lamp comes on when main voltage is present.

The letters following the SHERPA/D models mean:

First letter: **R**: round **C**: square

Second letter: **C**: with visor **S**: without visor

The SHERPA/D models do NOT include the recessing box in their prices.



Sherpa Series

The embryo of the entire range of Daisalux beacons. Its operation as a centralized or self-contained beacon, its square or rounded forms, the diffusers with or without a visor, its different finishes, its functions as either a courtesy or emergency beacon, in short, a new spectrum of possibilities as a response to a Daisalux rationalisation process in order to meet beaconing needs.

Model	Voltage	Emerg. Lamp	Charging monitor
SHERPA/C Series (Addressable)			
SHERPA/C RC	PBS units (see pages 162 and 163)	Incandescent	Red LED (3)
SHERPA/C RS	PBS units (see pages 162 and 163)	Incandescent	Red LED (3)
SHERPA/C CC (1)	PBS units (see pages 162 and 163)	Incandescent	Red LED (3)
SHERPA/C CS (1)	PBS units (see pages 162 and 163)	Incandescent	Red LED (3)
Finishes (for SHERPA/C beacons)			
Finish of:	Description		Marking
Voltage	24V DC (to be supplied with a PBS-20 or a PBS-60 unit)* 12V DC (to be supplied with a PBS-10 unit)* (2) * See beacon lighting battery-powered units section in pages 162 and 163		---- (12V)
Colour or bath	NEXTEL GREY (standard) PAINTED WHITE	Mod: -RC and -RS Mod: -CC and -CS	---- (WHITE) (WHITE)
	GOLD	Mod: -RC and -RS Mod: -CC and -CS	(GOLD) (GOLD)
	CHROMED	Mod: -RC and -RS Mod: -CC and -CS	(CHROME) (CHROME)
	GRAPHITE	Mod: -RC and -RS Mod: -CC and -CS	(GRAPHITE) (GRAPHITE)
	NICKEL-PLATED	Mod: -RC and -RS Mod: -CC and -CS	(NICKEL) (NICKEL)
Accessories			
Reference:	Description		
KE SHERPA	Recessing box Sherpa		

Example of order:

Order for 8 centralized SHERPA beacons, 12V DC, round, without visor, chrome colour + 1 PBS-10:

8 SHERPA/C RS (12V) (CHROME) + 1 PBS-10

Operation, Common Data and Notes (SHERPA/C)

(1) May be installed in a universal junction box.

(2) Beacons must be ordered with the 12V finish (12V) when supplied with a PBS-10.

(3) If you need other LED colours, please check with the factory.

The letters following the SHERPA/C reference mean:

First letter: **R**: Round, **C**: Square

Second letter: **C**: With visor, **S**: Without visor

OPERATION: The Sherpa/C model light up 2 red leds when mains voltage is present. A 1,2W incandescent lamp lights up when mains voltage is absent.

The SHERPA/C model does not include recessing box as standard.

PBS units for supplying beacon models (SHERPA/C)

PBS 10

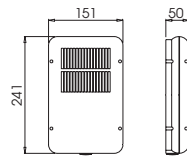

PBS-20
PBS-60

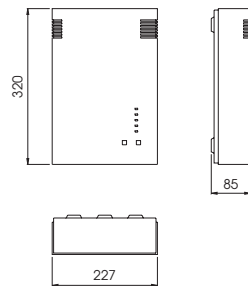

PBS Units

They are battery-charger units designed to assure the beacons of a correct supply. PBS-20 and PBS-60 units for 24V AC/DC centralized beacons and PBS-10 units for 12V AC/DC centralized beacons.

Model	Input Voltage	Voltage mains present	Voltage mains absent	Autonomy	N° of SHERPA/C beacons supplied
(Centralized beacon supply)					
PBS-10 (1)	230V AC	-6V AC	+12V DC	1 h	10
PBS-20	230V AC	-6V DC	+24V DC	1 h	20
PBS-60	230V AC	-6V DC	+24V DC	1 h	60

Measurements

(See Dimensions chart on the previous page)

Operation, Common Data and Notes

(1) The PBS-10 units can only supply beacons with the 12V finish.

Construction details: Conforming to Community Electromagnetic Compatibility, Low Voltage and **RoHS** Directives 2004/108/EC, 2006/95/EC and 2002/95/EC / Epoxy powder treated metal housing on models PBS 20 and PBS 60 / ABS housing, 650°C according to EN 60598 (IEC 60598) and EN 60695-2-1 (IEC 60695-2-1), on model PBS 10 / High-temperature sealed Ni-Cd rechargeable batteries EN 60285 (IEC 60285) / Battery protected against overcurrents, excessive discharges and polarity reversal / Protection for use with outside access / Automatic stand-by setting in case of short-circuits in the system / Non-resistive charging system that extends battery life / OFF/ON button for activating or deactivating the unit / Timed TEST button for activating emergency state simulation / Pilot indicator LEDs: MAINS, ON, OFF, CHARGING and FUSE: / Stand-by setting by remote control / Remote control circuit protected against connection errors / Test by remote control in presence of mains supply / Protection against electric shocks: Class I on PBS 20 and 60. Class II on PBS 10 / **IP 20 IK 04** / 100% functional testing of production with computer-electronic systems.

Rechargeable torches

Long range
Housing made of ABS,
halogen lamp in PAR 36
pressed glass.

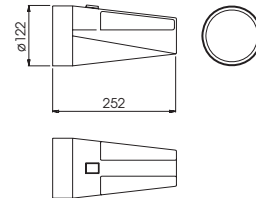

Open beam
Housing made of ABS,
aluminium-plated reflector
and pressed glass diffuser.

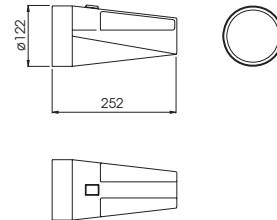

Wall charger
Housing made of ABS with
fibreglass and chromed
brass contact terminals.

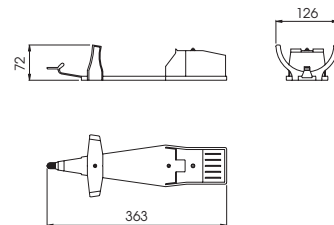

Long range strap
Aluminium metal box painted
with epoxy powder paint.
Black. Halogen lamp in PAR
36 pressed glass.

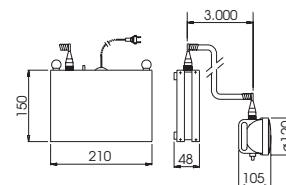

Rechargeable torch Series

Industry, repair shops, transport, the home, outdoor activities or sports, etc... are some of the everyday situations for which the Daisalux family of portable lighting appliances are intended. They are hand-held light sources consisting of units of two different types: torches with a built-in charger and torches with a wall charger.

Model	Power	Autonomy
Without charger (1):		
L-24NC	3 W	3 h
L-24LC	2,4 W	4 h
L-26NC	3 W	5 h
L-26LC	2,4 W	7 h
L-34NC	3,6 W	4 h
JET (2)	8 W	3 h
With built-in charger (230V):		
L-24N	3 W	3 h
L-24L	2,4 W	4 h
L-26N	3 W	5 h
L-26L	2,4 W	7 h
JET BANDOLERA (3)	8 W	5 h

Accessories

Reference: Description

Wall chargers:

C-24	For connecting at 230V or AC 12V DC to order*
C-26	For connecting at 230V or AC 12V DC to order*
C-34	For connecting at 230V or AC 12V DC to order*
C-JET	For connecting at 230V or AC 12V DC to order*

*(For other voltages, please check whit the factory)

Example of order:

Order for 10 rechargeable torches with bult-in charger of 2,4 W and 4 hours of autonomy:
10 L-24L

Operation, Common Data and Notes

(1) Torches without charger need a wall charger.

(2) Long range PAR 36 halogen lamp with concentrated beam, maxim intensity of 25.000 cd.

(3) The JET BANDOLERA model is supplied with 230V AC charger and connection for charge at 12V DC.

Conforming to Community Electromagnetic Compatibility, Low Voltage and **RoHS** Directives 2004/108/EC, 2006/95/EC and 2002/95/EC.

Sealed fluorescent screens

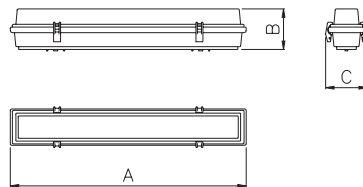

SEALED	A	B	C
20 N7, 20 P7	666	110	100
40 N12, 40 N24, 40 2N14 40 P12, 40 P24, 40 2P14	1276	110	100
20 C7	666	110	170
40 C12, 40 C24, 40 2C14	1276	110	170

Sealed fluorescent screen series

Resistant to smoke, dust and humidity, sealed fluorescent screens assure reliable lighting in the worst conditions and in large areas with mains voltage present or absent.

Model	Emerg. Lamp	Autonomy	Mains present lamp	Lumens in emergency
Non maintained: (1)				
ESTANCA-20 N7	FL 18 W	1 h	-	210
ESTANCA-40 N12	FL 36 W	1 h	-	665
ESTANCA-40 N24	FL 36 W	1 h	-	1200
ESTANCA-40 2N14	FL 36 W	2 h	-	715
Maintained: (2)				
ESTANCA-20 P7	FL 18 W	1 h	FL 18 W	210
ESTANCA-40 P12	FL 36 W	1 h	FL 36 W	665
ESTANCA-40 P24	FL 36 W	1 h	FL 36 W	1200
ESTANCA-40 2P14	FL 36 W	2 h	FL 36 W	715
Combined: (3)				
ESTANCA-20 C7	FL 18 W	1 h	FL 18 W	210
ESTANCA-40 C12	FL 36 W	1 h	FL 36 W	665
ESTANCA-40 C24	FL 36 W	1 h	FL 36 W	1200
ESTANCA-40 2C14	FL 36 W	2 h	FL 36 W	715

Example of order:

Order for 10 SEALED fluorescent screens, IP 65 IK 08, maintained, 1.200 lumens, 36W:
10 ESTANCA-40 P24

Operation, Common Data and Notes

- (1) *Non-maintained: Operation only in the event of an emergency.*
 (2) *Maintained appliances have two supply inputs, LUM and EMERG, and may be switched off when mains voltage is present.*
 (3) *Combined models have two tubes, one of which can be switched on and off with mains voltage present, while the other comes into operation in the event of a power failure.*
The Non-maintained and Combined models are manufactured in compliance with EN 20-392-93 (IEC 20-392-93), and Maintained models are manufactured in compliance with EN 60598-2-22 (IEC 60598-2-22).

Constructional details: Built to EN 60598-2-22 (IEC 60598-2-22) standard / Conforming to Community Electromagnetic Compatibility, Low Voltage and RoHS Directives 2004/108/EC, 2006/95/EC and 2002/95/EC / Built to synthetic materials, 850°C to EN 60598-1 (IEC 60598-1) and EN 60695-2-1 (IEC 60695-2-1), according to models / Metal reflector treated with epoxy powder paint / High temperature sealed rechargeable Ni-Cd batteries to EN 60285 (IEC 60285) / Battery protected against overcurrents, excessive discharges and polarity reversal / Mains input thermal protector / Battery charging warning light / Setting on stand-by by remote control / Remote control circuit protected against connection errors / Testing by remote control when mains voltage is present / Electric shock protection: Class I / Luminaire suitable for mounting on normally inflammable surfaces: Class "F" / Protection Class **IP 65 IK 08** / 100% functional testing of production with computer-electronic systems.

Converters

BEC 64, 124

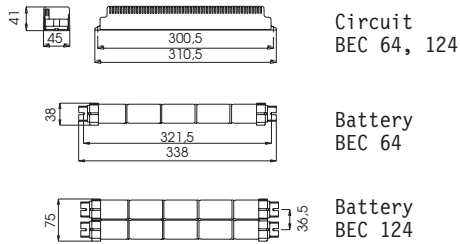

BEC 715

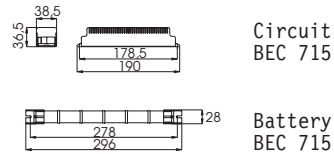

Construction details: Electronic ballast built to EN 61347-1 (IEC 61347-1), EN 61347-2-7 (IEC 61347-2-7) standard / Built to EN 60598-2-22 (IEC 60598-2-22) standard / Conforming to Community Electromagnetic Compatibility, Low Voltage and **RoHS** Directives 2004/108/EC, 2006/95/EC and 2002/95/EC / Built to synthetic materials, 850°C to EN 60598-1 (IEC 60598-1) and EN 60695-2-1 (IEC 60695-2-1), according to models / High temperature sealed Ni-Cd rechargeable batteries to EN 60285 (IEC 60285) / Battery protected against overcurrents, excessive discharges and polarity reversal / Battery charging warning light / Setting on stand-by by remote control or switch / Remote control circuit protected against connection errors / Testing by remote control when mains voltage is present / Protection against electric shocks: Class II / Suitable for fitting on normally inflammable surfaces: Class "F" / Suitable for installing on fluorescent screens with conventional or electronic reactances / **IP 20** / 100% functional testing of production with computer-electronic systems / Mains input thermal protector.

Converter Series

The family of Daisalux emergency kits is made up of a set of charger-converter model D devices, battery module, charging monitor and connection cables, which enables a standard fluorescent luminaire to be converted into an emergency luminaire. All the part numbers may be connected to luminaires that operate with an electronic ballast or with a choke and starter.

CONVERTER FOR FLUORESCENT AND PL LAMPS (CHARGER/CONVERTER + BATTERY)

Model	Lamp	Battery	Operation (1)(4)
BEC 124	from 11 to 58 W	Ni-Cd Sealed	Remote-controllable
BEC 124i	from 11 to 58 W	Ni-Cd Sealed	Switch disabling
BEC 64	from 11 to 58 W	Ni-Cd Sealed	Remote-controllable
BEC 64i	from 11 to 58 W	Ni-Cd Sealed	Switch disabling
BEC 715 (5)	from 11 to 58 W	Ni-Cd Sealed	Remote-controllable
BEC 715i (5)	from 11 to 58 W	Ni-Cd Sealed	Switch disabling

AUTONOMY AND OUTPUTS ACCORDING TO THE DIFFERENT LAMPS

Lamp	Autonomy - Output (2)				Model
	Aut. > 1 h.	Aut. > 1,5 h.	Aut. > 2 h.	Aut. > 3 h.	
PL-2 (267-2611) (3)					
PL36 W	1 h. - 38%	1,5 h. - 70%	2,5 h. - 39%	---	BEC 124
	1 h. - 22%	---	2,5 h. - 21%	---	BEC 64
PL26 W	1 h. - 51%	---	2 h. - 72%	---	BEC 124
	1 h. - 29%	---	2,5 h. - 30%	---	BEC 64
PL24 W	---	1,5 h. - 85%	---	3 h. - 49%	BEC 124
	1 h. - 36%	1,5 h. - 47%	---	3 h. - 27%	BEC 64
PL18 W	---	---	2,5 h. - 80%	4,5 h. - 47%	BEC 124
	1 h. - 37%	1,5 h. - 28%	2 h. - 45%	4 h. - 27%	BEC 64
PL11 W	---	1,5 h. - 98%	---	3,5 h. - 98%	BEC 124
	1 h. - 71%	1,5 h. - 56%	---	3 h. - 56%	BEC 64
PL-4 or PL-6 (2624q - GX24q) (3)					
TE-32 W	---	1,5 h. - 75%	2,5 h. - 47%	---	BEC 124
	1 h. - 26%	1,5 h. - 38%	2,5 h. - 25%	---	BEC 64
TE-26 W	---	1,5 h. - 81%	3 h. - 46%	---	BEC 124
	1 h. - 34%	1,5 h. - 41%	2,5 h. - 29%	---	BEC 64
PL13 W	---	---	2 h. - 73%	3,5 h. - 87%	BEC 124
	1 h. - 63%	---	---	3 h. - 48%	BEC 64
FL 26 mm. (613)					
FL58 W	1 h. - 52%	---	2 h. - 29%	---	BEC 124
	1 h. - 28%	---	2 h. - 14%	---	BEC 64
	1 h. - 15%	---	---	---	BEC 715
FL36 W	1 h. - 70%	---	2,5 h. - 40%	---	BEC 124
	1 h. - 38%	---	2,5 h. - 20%	---	BEC 64
FL18 W	---	---	2 h. - 91%	4 h. - 52%	BEC 124
	1 h. - 39%	1,5 h. - 30%	2 h. - 48%	3,5 h. - 29%	BEC 64
2xFL18 W	1 h. - 77%	---	2,5 h. - 42%	---	BEC 124
	1 h. - 42%	1,5 h. - 29%	---	---	BEC 64
T5 - FL 16 mm. (65)					
FQ39 W	1 h. - 82%	---	2 h. - 46%	---	BEC 124
	1 h. - 41%	---	2 h. - 24%	---	BEC 64
FQ-24 W	---	1,5 h. - 90%	3 h. - 52%	---	BEC 124
	1 h. - 29%	1,5 h. - 45%	2,5 h. - 28%	---	BEC 64
FH-21 W	1 h. - 73%	---	2 h. - 78%	---	BEC 124
	1 h. - 41%	---	2 h. - 39%	---	BEC 64
FH-14 W	---	1,5 h. - 72%	3 h. - 85%	---	BEC 124
	1 h. - 62%	---	3 h. - 47%	---	BEC 64

CONVERTERS FOR HALOGEN LAMPS (CHARGER/CONVERTER + BATTERY)

Model	Lamp	Battery	Operation (4)
BEC 124H	12V	Ni-Cd Sealed	Remote-controllable
BEC 124Hi	12V	Ni-Cd Sealed	Switch disabling
BEC 64H	6V	Ni-Cd Sealed	Remote-controllable
BEC 64Hi	6V	Ni-Cd Sealed	Switch disabling

AUTONOMY AND OUTPUT ACCORDING TO THE DIFFERENT LAMPS

HALOGEN LAMP	BEC 124H, 124Hi	BEC 64H, 64Hi
	Autonomy	Autonomy
12V-50W	> 45 min.	---
12V-35W	> 1 h.	---
12V-20W	> 1 h 45 min.	---
6V-10W	---	> 1 h 45 min.

Example of order:

Order for 45 Converters for a 18W fluorescent tube, 1 hour of autonomy, minimum output 35% and maintained operation:

45 BEC 715

Operation, Common Data and Notes

- All emergency kits have two operation levels: high level and low level.
 - The output indicates the percentage of power with which the lamp is supplied in a state of emergency in relation to its power rating.
 - Compact lamps with a built-in starter may NOT be connected to this kit.
 - * Remote-controllable means that it can be switched ON and OFF when mains voltage is absent.
* Switch disabling means that it can be kept ON and OFF either with or without mains voltage. With the switch open the luminaire will not be switched on in the event of a power failure.
 - When wishing to use the model BEC 715, 715 i with electronic choke, you should refer to the instructions sheet or contact the Daisalux technical department to confirm how it should be connected.
- Built to EN 61347-1 (IEC 61347-1) and EN 61347-2-7 (IEC 61347-2-7) standards / Suitable for complying EN 60598-2-22 (IEC 60598-2-22).

Fluorescent Ballasts

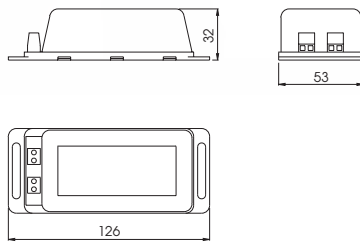

Fluorescent Ballasts

Daisalux ballasts enable you to start fluorescent tubes from a direct current power source, so they may be installed in centralized emergency lighting systems, motor vehicles, boats, etc...

Model		Technical characteristics				Power
BE 3612	Tubes...	13 / 15 W	18 / 20 W	36 / 40 W	58 / 60 W	12V DC
	Consumption	0,70 A	1,1 A	1,82 A	2,15 A	
	Lumens	560	870	1.780	2.030	
BE 3624	Tubes...	13 / 15 W	18 / 20 W	36 / 40 W	58 / 60 W	24V DC
	Consumption	0,37 A	0,62 A	0,98 A	0,94 A	
	Lumens	600	980	1.920	1.770	
BE 3648	Tubes...	13 / 15 W	18 / 20 W	36 / 40 W	58 / 60 W	48V DC
	Consumption	0,24 A	0,39 A	0,67 A	0,67 A	
	Lumens	700	1.230	2.630	2.530	
BE 36110	Tubes...	13 / 15 W	18 / 20 W	36 / 40 W	58 / 60 W	110V DC
	Consumption	0,10 A	0,16 A	0,27 A	0,27 A	
	Lumens	740	1.160	2.430	2.340	
BE 812	Tubes...	8 W	11 W			12V DC
	Consumption	0,70 A	1 A	-	-	
	Lumens	510	860			
BE 824	Tubes...	8 W	11 W			24V DC
	Consumption	0,50 A	0,65 A	-	-	
	Lumens	510	990			
BE 848	Tubes...	8 W	11 W			48V DC
	Consumption	0,22 A	0,29 A	-	-	
	Lumens	510	990			
BE 8110	Tubes...	8 W	11 W			110V DC
	Consumption	0,1 A	0,12 A	-	-	
	Lumens	510	950			

Example of order:

Order for 20 ballasts at 48V DC for supplying a fluorescent tube of 36W:
20 BE 3648

Operation, common data and notes

The compact lamps with built-in starter may not be connected to any of these ballasts.

Construction details: Built to EN 61347 (IEC 61347) standard / Conforming to Community Electromagnetic Compatibility, Low Voltage and RoHS Directives 2004/108/EC, 2006/95/EC and 2002/95/EC / ABS base and cover. 650°C to EN 60598-1 (IEC 60598-1) and EN 60695-2-1 (IEC 60695-2-1) / Symmetrical high-frequency tube starting / Resonant cold technology / 100% functional testing of production with computer-electronic systems.

T13-S/T13 Units

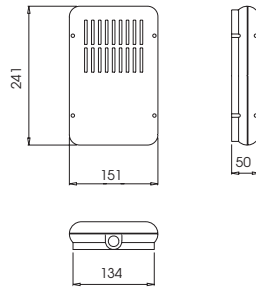

T13-S Units

It is an emergency unit that has a siren that can be activated either with mains voltage present or absent and which also provides a 6VDC output in case of a power failure that may be used for supplying an emergency lamp.

Model	Autonomy	Battery Ni-Cd	Output		
			Voltage	Operation mains present	Operation mains absent
(Lifts and cold stores)					
T13-S	> 1 h.	6V 1.5 Ah	6V DC	Alarm only at discretion (button-operated) if decided	Automatic emergency lighting and automatic or button-operated alarm (as desired)

Accessories

Reference:	Description
T13-ACS	Accessory for increasing alarm sound.
SATEL	35-lumen ceiling light fitting.

Note

Other applications. Automatic power failure alarm.

T13 Units

Model	Autonomy	Battery Ni-Cd	Output	
			Voltage	Output power
T13-61P (1)	> 1 h.	6V 1.2 Ah	6V DC	6.5 W
T13-21P (1)	> 1 h.	12V 1.2 Ah	12V DC	13 W
T13-61 (2)	> 1 h.	6V 1.2 Ah	6V DC	6.5 W
T13-21 (2)	> 1 h.	12V 1.2 Ah	12V DC	13 W

Measures

(See Dimension Chart on previous page)

Example of order:

Order for 6 acoustic alarm and luminaire power supply units, SATEL model, 6W output, 230V AC supply:

6 T13-S

6 SATEL

Operation, common data and notes

(1) For supplying alarms, relays, electrovalves and operation at discretion with mains voltage present and absent.

(2) For operation in the event of emergency

Construction details: Conforming to Community Electromagnetic Compatibility, Low Voltage and **RoHS** Directives 2004/108/EC, 2006/95/EC and 2002/95/EC / Safety transformer to EN 742 (IEC 742) / High temperature sealed Ni-Cd rechargeable batteries / Battery protected against overcurrents, excessive discharges and polarity reversal / Stand-by setting by remote control on T13-S / Remote control circuit protected against connection errors on T13-S / Test by remote control with mains voltage present on T13-S / Electric shock protection: Class II / **IP 20 IK 04** on T13-S / **IP 44 IK 04** on T13 and T13-P / Loudspeaker with plastic cone on T13-S / 100% functional testing of production with computer-electronic systems.

Centralized DNH Units

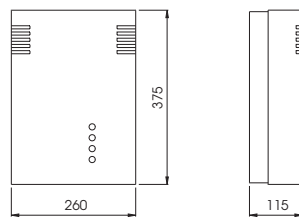

Battery-powered units: DNH Series

DNH units supply electric power at 12V to security, emergency, etc. systems. Normal applications: Supplying halogen, incandescent, etc. lamps to be used as emergency lighting. Supplying security systems, alarms, etc...

Two types of units: TYPE E UNITS. They work as emergency lighting only. TYPE EP UNITS. They work both when mains voltage is present and absent.

Model	Autonomy	Battery Ni-Cd	Output		
			Lamp output	Voltage mains present	Voltage mains absent
(Supply for halogen lamps)					
Non maintained:					
DNH-50E	> 1 h	12V 7Ah	50 W	-----	12V DC
DNH-50EP	> 1 h	12V 7Ah	50 W	12V AC	12V DC
DNH-100E	> 1 h	2X12V 7Ah	100 W	-----	12V DC
DNH-100EP	> 1 h	2X12V 7Ah	2X50 W	12V AC	12V DC

Measurements

(See Dimension Charts on previous page)

Example of order:

Order for 1 centralized emergency unit for supplying halogen lamps, non maintained, autonomy higher than 1 hour at 12V AC 50 W, whit mains voltage present and 12V DC whit mains voltage absent:

1 DNH-50 EP

Constructional details: Conforming to Community Electromagnetic Compatibility, Low Voltage and **RoHS** Directives 2004/108/EC, 2006/95/EC and 2002/95/EC / Metal housing treated with epoxy powder paint / High temperature sealed Ni-Cd rechargeable batteries / Battery protected against overcurrents, excessive discharges and polarity reversal / Non-resistive charging system that lengthens battery life / Supply and use protectors with external access exterior / Charging indicator LED / Stand-by setting by remote control / Remote control circuit protected against connection errors / Test by remote control with mains voltage present / Electric shock protection: Class I / **IP 20 IK 04** / 100% functional testing of production with computer-electronic systems.

Centralized DINN Units

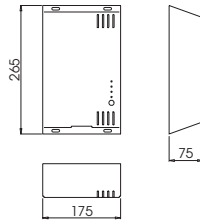

Battery-powered units: DINN Series

The DINN units are uninterrupted power supply sources formed basically of a sealed NiCd storage battery and an electronic control circuit. They supply a DC voltage output. The electronic control circuit is executed with cold technology. This favours operating conditions and lengthens the life of the storage cells. These units include charger protection against excessive consumption, protection against shorts at the output, protection against incorrect mains connection and protection against a faulty battery.

Model	Autonomy	Battery Ni-Cd	Output				
			Lamp output power	Peak consumption power	Voltage mains present	Voltage mains absent	Maximum ripple voltage
(Application in Energy Transformation Centrals)							
Maintained:							
DINN 24	> 1 h 30 min.	24V 1,5 Ah	15 W	72 W	24V DC	24V DC	1%
DINN 48	> 3 h	48V 1,5 Ah	15 W	144 W	48V DC	48V DC	1%
Measurements (See Dimension Chart on previous page)							

Example of order:

Order for 1 centralized emergency unit, maintained, autonomy higher than 3 hours at 48V DC with mains voltage present and 48V DC with mains voltage absent:

1 DINN 48

Constructional details: Unit suitable for complying with EN 50171 (IEC 50171): Centralized supply systems / Conforming to Community Electromagnetic Compatibility, Low Voltage and **RoHS** Directives 2004/108/EC, 2006/95/EC and 2002/95/EC / Metal housing treated with epoxy powder paint / High temperature sealed Ni-Cd rechargeable batteries / Battery protected against overcurrents, excessive discharges and polarity reversal / Quick battery change by means of a plug-in system / High frequency switched charging system (100 KHz) which lengthens the life of the battery / Output ripple 0.1 / Output short-circuit protection by current limitation and fuse with external access / Voltage limiter in case of battery being on open circuit / Spare minimum battery voltage potential contact / Excessive consumption protection / Signalling LEDs: MAINS, CHARGING, VOLTAGE, NORMAL AND FAILURE / Remote control circuit protected against connection errors / Electric shock protection: Class I / **IP 20 IK 04** / Quick plug-in connection / 100% functional testing of production with computer-electronic systems.

Centralized DEN Units



12V and 24V Units



48V Units

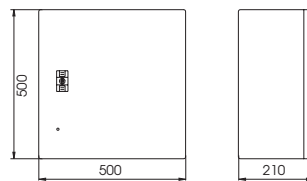

110V Units

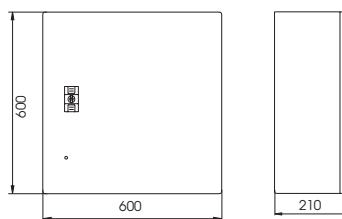

Battery-powered units: DEN Series

Daisalux DEN units switch to the emergency state when there is a power failure and they supply direct voltage from their internal battery (sealed Ni-Cd). When mains voltage is present, they can supply either AC or DC voltage or nothing:

- DENA... When mains voltage is present it supplies AC voltage and when there is a power failure, DC voltage. Units of this type are normally used to supply incandescent lamps.
- DENC... It supplies DC voltage both when mains voltage is present and absent. They are normally used to supply DC ballasts, coils, etc...
- DENS... It only supplies voltage when there is a power failure.

When mains voltage is present, a green LED indicates that the batteries are being charged

Model	Autonomy	Battery Ni-Cd	Output			
			Voltage mains present	Voltage mains absent	Maximum power	Maximum current
Only in emergency: (1)						
DENS 12 / 43	> 1 h	12V 4 Ah	-	12V DC	43 W	3,6 A
DENS 12 / 75	> 1 h	12V 7 Ah	-	12V DC	75 W	6,3 A
DENS 24 / 86	> 1 h	24V 4 Ah	-	24V DC	86 W	3,6 A
DENS 24 / 151	> 1 h	24V 7 Ah	-	24V DC	151 W	6,3 A
DENS 48 / 172	> 1 h	48V 4 Ah	-	48V DC	172 W	3,6 A
DENS 48 / 302	> 1 h	48V 7 Ah	-	48V DC	302 W	6,3 A
DENS 110 / 396	> 1 h	110V 4 Ah	-	110V DC	396 W	3,6 A
DENS 110 / 693	> 1 h	110V 7 Ah	-	110V DC	693 W	6,3 A
Normal and emergency lighting: (2)						
DENA 12 / 43	> 1 h	12V 4 Ah	12V AC	12V DC	43 W	3,6 A
DENA 12 / 75	> 1 h	12V 7 Ah	12V AC	12V DC	75 W	6,3 A
DENA 24 / 86	> 1 h	24V 4 Ah	24V AC	24V DC	86 W	3,6 A
DENA 24 / 151	> 1 h	24V 7 Ah	24V AC	24V DC	151 W	6,3 A
DENA 48 / 172	> 1 h	48V 4 Ah	48V AC	48V DC	172 W	3,6 A
DENA 48 / 302	> 1 h	48V 7 Ah	48V AC	48V DC	302 W	6,3 A
DENA 110 / 396	> 1 h	110V 4 Ah	110V AC	110V DC	396 W	3,6 A
DENA 110 / 693	> 1 h	110V 7 Ah	110V AC	110V DC	693 W	6,3 A
Normal and emergency lighting: (3)						
DENC 12 / 43	> 1 h	12V 4 Ah	12V DC	12V DC	43 W	3,6 A
DENC 12 / 75	> 1 h	12V 7 Ah	12V DC	12V DC	75 W	6,3 A
DENC 24 / 86	> 1 h	24V 4 Ah	24V DC	24V DC	86 W	3,6 A
DENC 24 / 151	> 1 h	24V 7 Ah	24V DC	24V DC	151 W	6,3 A
DENC 48 / 172	> 1 h	48V 4 Ah	48V DC	48V DC	172 W	3,6 A
DENC 48 / 302	> 1 h	48V 7 Ah	48V DC	48V DC	302 W	6,3 A
DENC 110 / 396	> 1 h	110V 4 Ah	110V DC	110V DC	396 W	3,6 A
DENC 110 / 693	> 1 h	110V 7 Ah	110V DC	110V DC	693 W	6,3 A

Example of order:

Order for 1 centralized emergency unit for normal and emergency lighting, 12V DC with mains voltage present or absent and 43W maximum power:

1 DENC 12/43

Operation, Common Data and Notes

(1) DENS units: only in emergency (mains absent)

(2) DENA units: normal lighting (AC mains present) and emergency lighting (DC mains absent).

(3) DENC units: normal lighting (DC mains present) and emergency lighting (DC mains absent).

The range of units is limited according to output power and battery capacity.

Constructional details: Unit suitable for complying with EN 50171 (IEC 50171): Centralized supply systems / Conforming to Community Electromagnetic Compatibility, Low Voltage and RoHS Directives 2004/108/EC, 2006/95/EC and 2002/95/EC / Metal housing treated with epoxy powder paint / High temperature sealed Ni-Cd rechargeable batteries / Charging indicator LED / Electric shock protection: Class I / 12V and 24V units: Protection class **IP 55** / 48V and 110V units: Protection class **IP 21** / 100% functional testing of production with computer-electronic systems.

Luminaires and Specials

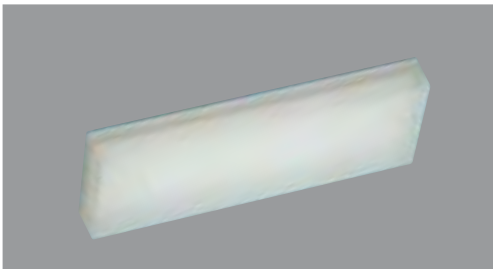
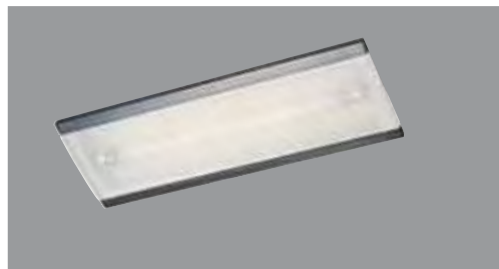
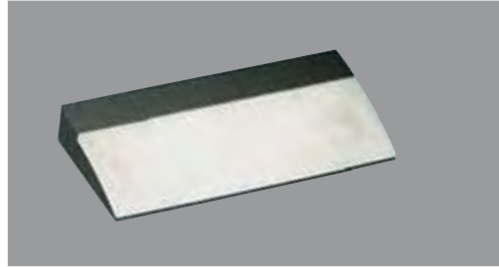
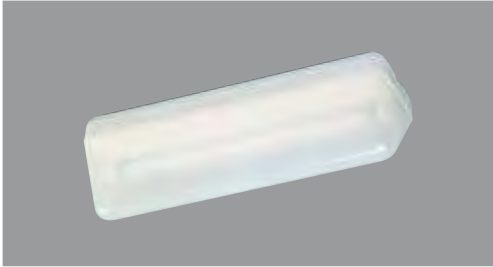

Series: Nova / Single Argos / Double Argos / Built-in Argos / Hydra / Myra / Norma / Iris / Sol / Zenit PL

Luminaires

Luminaires with the same formats as self-contained emergency appliances. They may be used either as a conventional luminaire which may be switched on and off at discretion only when mains voltage is present, as signage or part of an emergency lighting system with centralized battery units. AC and DC supply voltage are both accepted. Suitable for AC/DC power supply systems.

Model (1)	Voltage	Lamp	Series	Lumens
ARGOS L8	230V AC	FL 8 W	Single Argos	420
ARGOS-D L8	230V AC	FL 8 W	Double Argos	400
ARGOS-M L8	230V AC	FL 8 W	Built-in Argos	267
ARGOS-M L11	230V AC	PL 11 W	Built-in Argos	429
HYDRA L8	230V AC	FL 8 W	Hydra	400
HYDRA L16	230V AC	2FL 8 W	Hydra	590
IRIS L16	230V AC	2D 16 W	Iris	625
MYRA L16 (2)	230V AC	2D 16 W	Myra	685
NORMA L16	230V AC	2D 16 W	Norma	625
NOVA L8	230V AC	FL 8 W	Nova	330
NOVA L11	230V AC	PL 11 W	Nova	530
ORTO L11	230V AC	PL 11 W	Pennant Orto	400
ORTO-S L11	230V AC	PL 11 W	Surface Orto	280
ORTO-RE L11	230V AC	PL 11 W	Pennant recessed Orto	400
SOL L16	230V AC	2D 16 W	Sol	625
ZENIT-P L22	230V AC	2 x PL 11 W	Zenit	1.000
ZENIT-G L44	230V AC	4 x PL 11 W	Zenit	2.000

Notes

- (1) See accessories and finishes in the series page.
 (2) There are more than 180 exit signs for the Myra Series.
 Built in compliance with EN 60598-1 (IEC 60598-1).

Specials

Model	Autonomy	Voltage supply	Lumens	Emerg. Lamp
NOVA F8CR (1)	1 h.	230V AC	300	FL 8 W
NOVA CR48 (1) (2)	1 h.	48V DC	235	FL 8 W

Notes

- (1) Lights up upon detecting movement as of a given level of darkness.
 Includes IP 66 IK 08 box and infra-red detector (IP 44), with lighting period and lighting threshold regulating controls.
 (2) The NOVA CR48 can have a KPI accessory (weather protection cover). This accessory is exclusive for the NOVA CR48.
 Built in compliance with EN 60598-1 (IEC 60598-1).

Example of order:

Order for 25 luminaires Built-in Argos model with PL 11W lamp:
25 ARGOS-M L11

Construction details: Built to EN 60598-1 (IEC 60598-1) standard / Conforming to Community Electromagnetic Compatibility, Low Voltage and RoHS Directives 2004/108/EC, 2006/95/EC and 2002/95/EC / Built to synthetic materials, 850 °C to EN 60598-1 (IEC 60598-1) and EN 60695-2-1 (IEC 60695-2-1), according to models / Supply voltage: 230V AC/DC Available in other voltages / 8W, PL 11W or 2D 16W fluorescent lamps according to models / Electronic ballast to EN 60928 (IEC 60928) / Mains input thermal protector / Electric shock protection: Class II / Luminaire suitable for mounting on normally inflammable surfaces: Class "F" / 100% functional testing of production with computer-electronic systems / Disabling system in case of tube failure.

Remote Controls

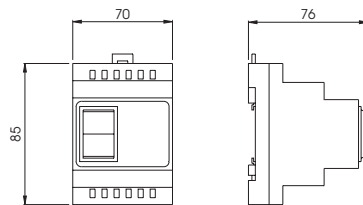

Remote Controls

Devices designed for controlling autonomous emergency appliances and equipment.

- Pressing ON sends a signal to the controlled appliances to enter emergency mode.
- Pressing OFF sends a signal to the controlled appliances to enter stand-by mode.

Model	Operation	Number of Units
Remote Control		
TD-50	Stand-by setting and restarting.	50
TD-100	Stand-by setting and restarting.	100
TD-50 T	Automatic stand-by setting after 5 minutes. Computer-controllable operation. Adds a timer-controlled automatic-off function to the basic control function when there is a mains failure. This timer can be cancelled simply by pressing the ON command.	50
TD-50 MP	Computer-controllable operation. Stand-by setting and restarting. Offers the option of control by potential-free remote external actions. When closing the contact, the relevant on or off command is sent.	50
TD-50 S	Acoustic and visual alarm during 30 seconds after a power failure. Stand-by and restart. Adds an acoustic and visual alarm to the basic control function, lasting approximately 30 seconds after the MAINS failure.	50

Measurements

(See Dimension Chart on previous page)

Example of order:

Order for 2 remote control systems with stand-by setting and restarting for 50 units:

2 TD-50

Construction details: Built to EN 60598-1 (IEC 60598-1), EN 60598-2-22 (IEC 60598-2-22), standards / MBTS classified according to standard EN 60598-1 (IEC 60598-1) / Conforming to Community Electromagnetic Compatibility, Low Voltage and **RoHS** Directives 2004/108/EC, 2006/95/EC and 2002/95/EC / ABS base and housing, 650°C to EN 60598-1 (IEC 60598-1) and EN 60695-2-1 (IEC 60695-2-1) / Sealed Ni-Cd rechargeable batteries / Battery charging warning LED / **IP 20 IK 04** / Operation by button-rocker switch / Quick fitting on track DIN 46277/3 / Quick connection / Stand-alone life of 75 operations / 100% functional production testing with computer-electronic systems.



self-activated luminaires
DC central power supply systems

daisalux

DAISALUX, S.A.U.- Polígono Industrial Júndiz - C/Ibarredi, 4 Apdo. 1578
01015 Vitoria (Spain) Tel. +34/945 29 01 81 - Fax: +34/945 29 02 29
e-mail: export@daisalux.com · <http://www.daisalux.com>

All the models shown in this catalogue has been created and patented by Daisalux, S.A.U. and it has its exclusive use. - Edition 2 - Revision 2. 25/04/08
Daisalux reserves the right of modifying the information contained in this catalogue without prior notification.