

Proyectores

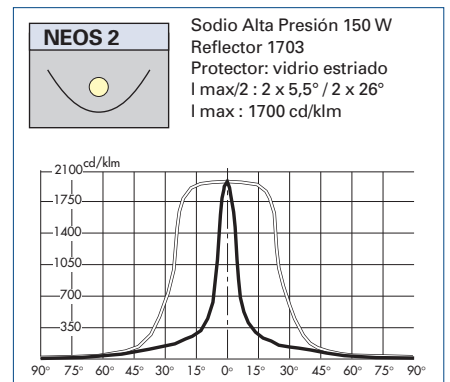

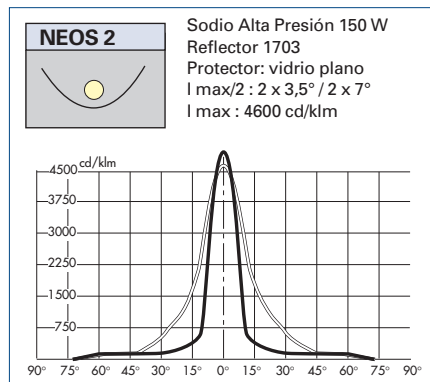

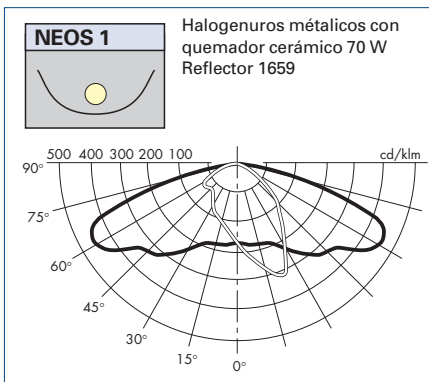
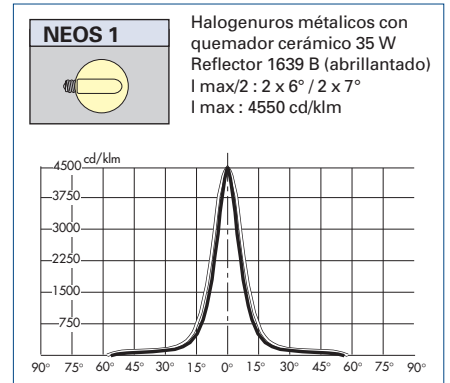
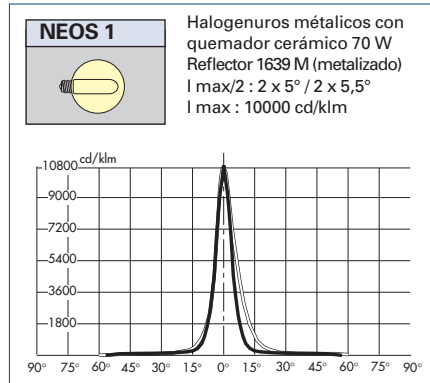
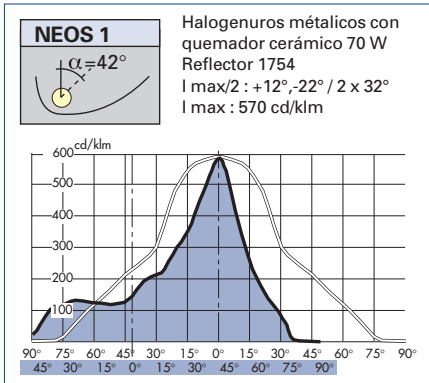
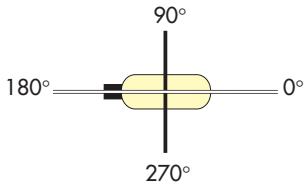
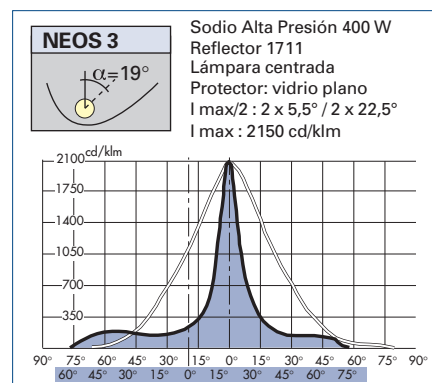
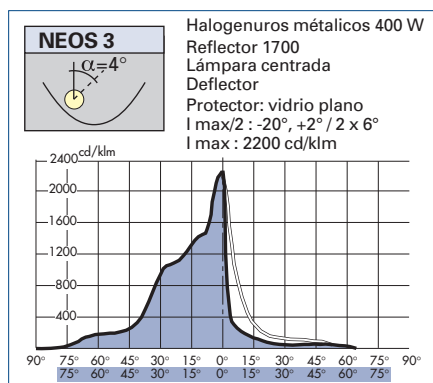
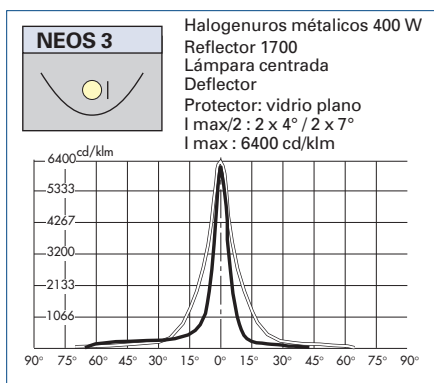
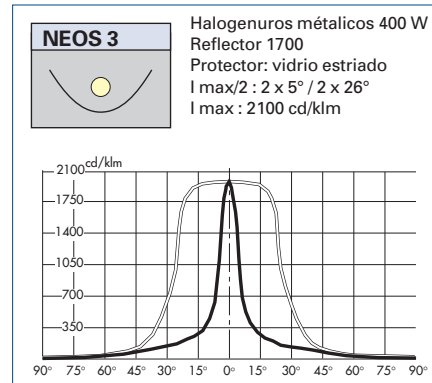
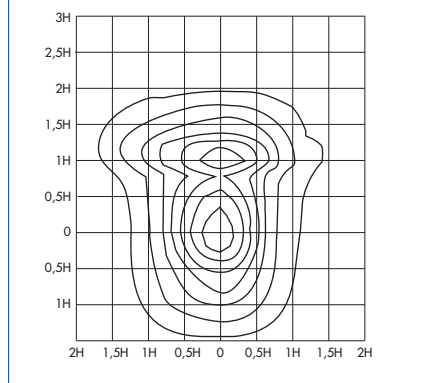
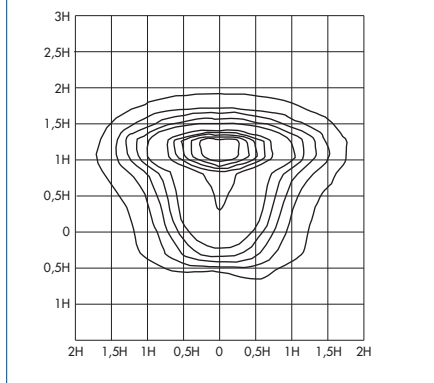
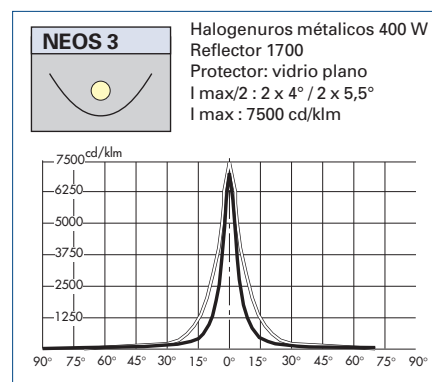
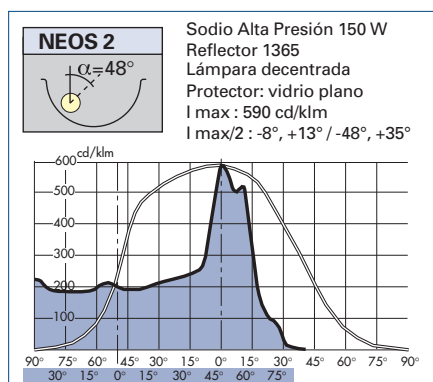
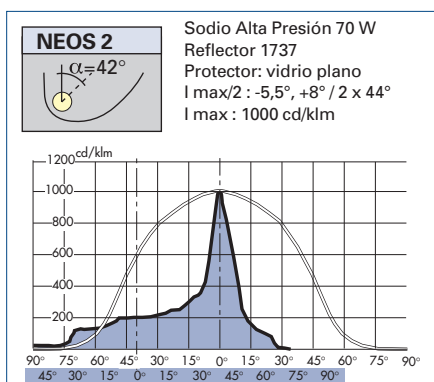
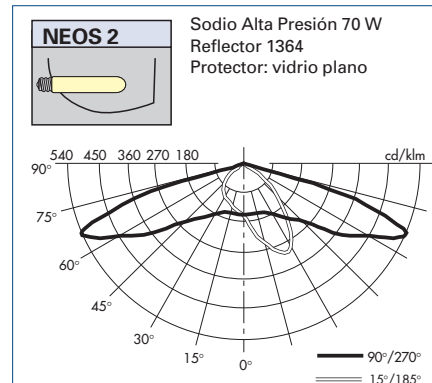
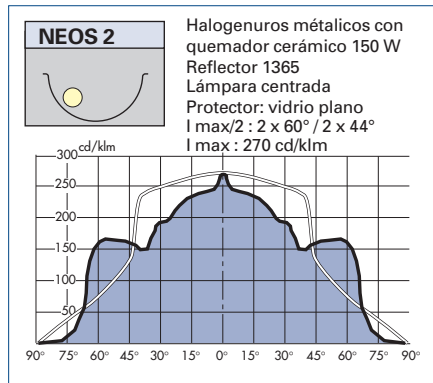
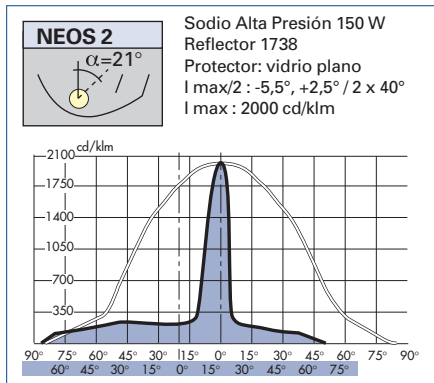
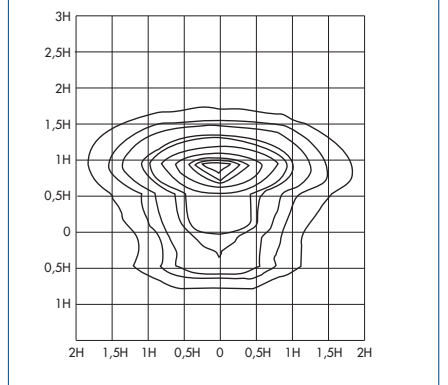
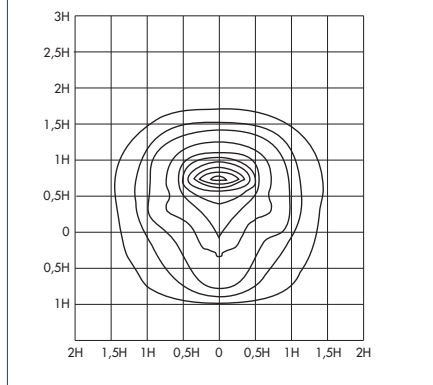
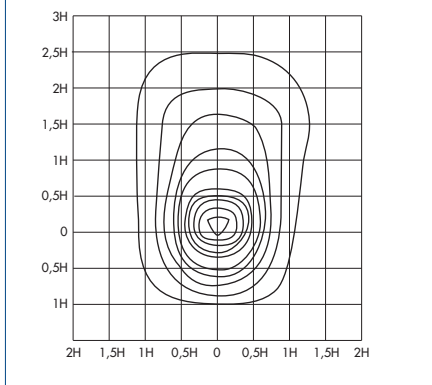
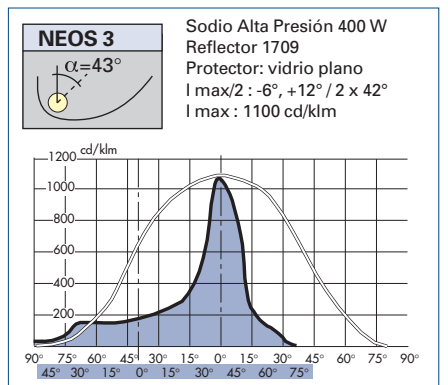
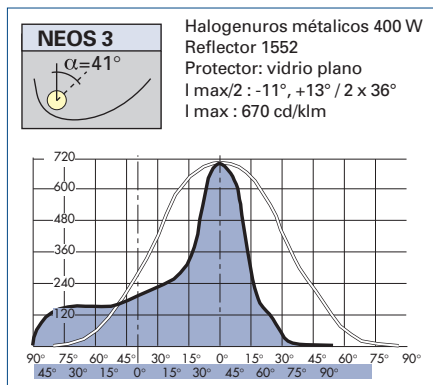
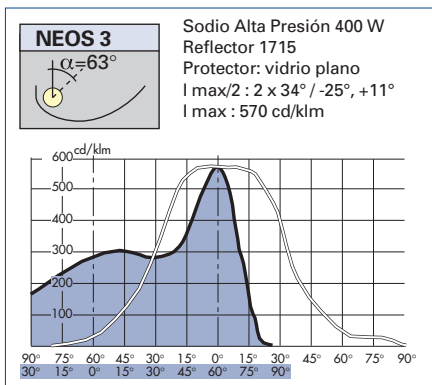
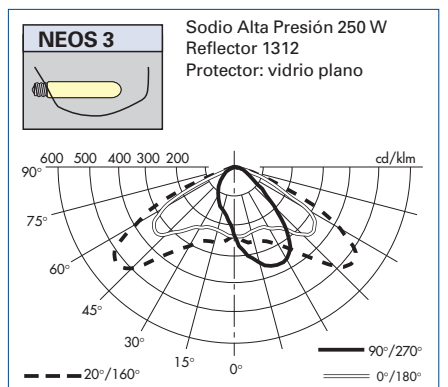
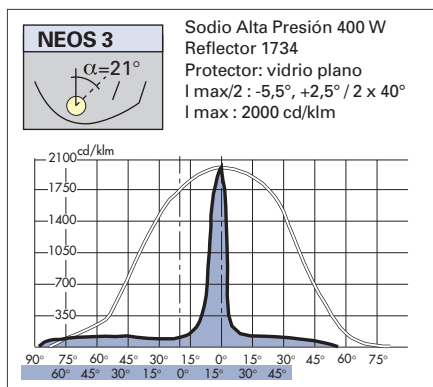
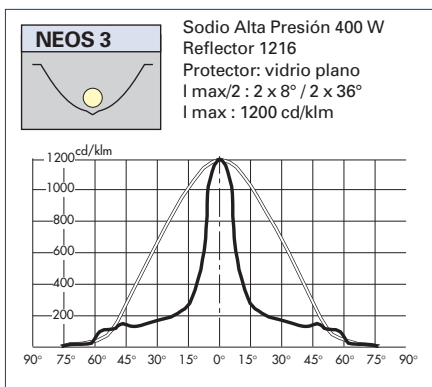
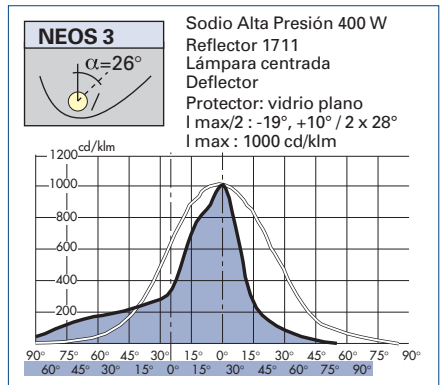
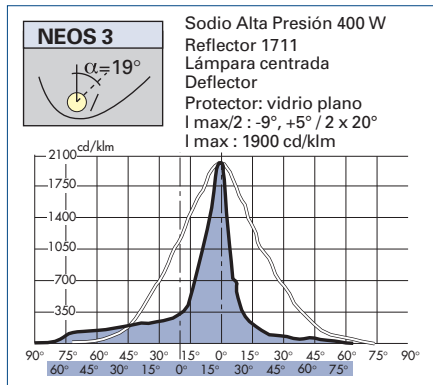
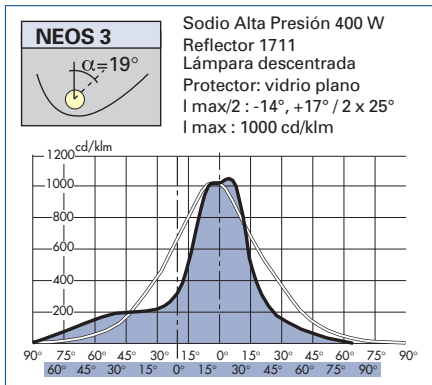
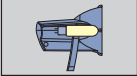

FOCAL

Sodio Alta presión 70 W
Reflector 1576
Protector: vidrio plano
I max/2 : 2x2,5° / 2x2,5°
I max : 8500 cd/klm

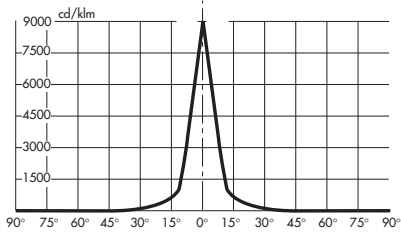
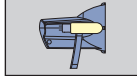
**FOCAL**

Sodio Blanco 100 W
Reflector 1576
Protector: vidrio plano
I max/2 : 2x2° / 2x2°
I max : 13500 cd/klm

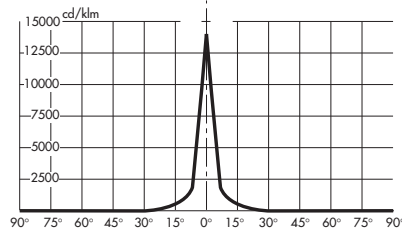
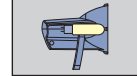
**FOCAL**

Halogenuros metálicos con quemador cerámico 150 W
Reflector 1576
Protector: vidrio plano
I max/2 : 2x3° / 2x3°
I max : 27000 cd/klm

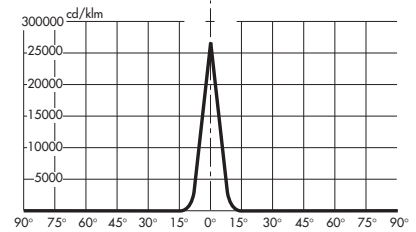
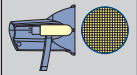
**FOCAL**

Halogenuros metálicos con quemador cerámico 70 W
Reflector 1691
Vidrio refractor Q1
I max/2 : 2x9° / 2x7,5°
I max : 4500 cd/klm

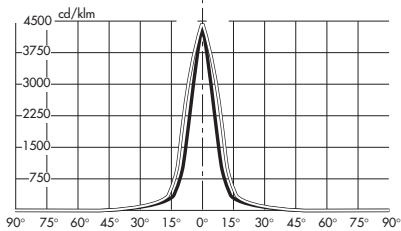
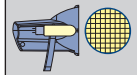
**FOCAL**

Halogenuros metálicos con quemador cerámico 70 W
Reflector 1691
Vidrio refractor Q2
I max/2 : 2x20° / 2x16°
I max : 1200 cd/klm

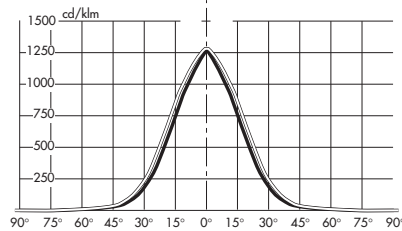
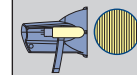
**FOCAL**

Halogenuros metálicos con quemador cerámico 70 W
Reflector 1691
Vidrio refractor L1
I max/2 : 2x31° / 2x6,5°
I max : 1800 cd/klm

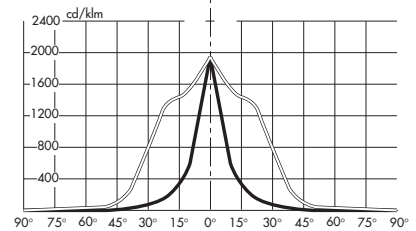
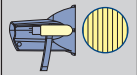
**FOCAL**

Halogenuros metálicos con quemador cerámico 70 W
Reflector 1691
Vidrio refractor L2
I max/2 : 2x20° / 2x16°
I max : 1000 cd/klm

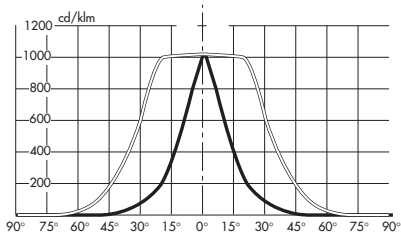
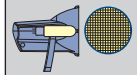
**FOCAL**

Halogenuros metálicos con quemador cerámico 70 W
Reflector 1641
Vidrio refractor Q1
I max/2 : 2x11° / 2x8°
I max : 2400 cd/klm

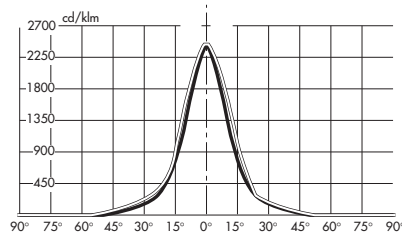
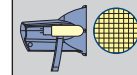
**FOCAL**

Halogenuros metálicos con quemador cerámico 70 W
Reflector 1641
Vidrio refractor Q2
I max/2 : 2x39° / 2x38°
I max : 370 cd/klm

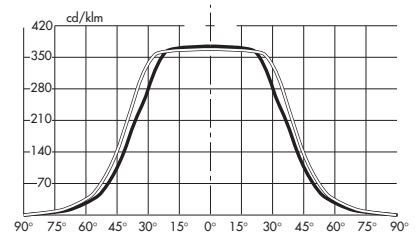
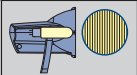
**FOCAL**

Halogenuros metálicos con quemador cerámico 70 W
Reflector 1641
Vidrio refractor L1
I max/2 : 2x25° / 2x7°
I max : 1400 cd/klm

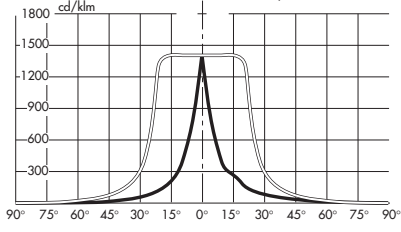
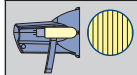
**FOCAL**

Halogenuros metálicos con quemador cerámico 70 W
Reflector 1641
Vidrio refractor L2
I max/2 : 2x52° / 2x36°
I max : 280 cd/klm

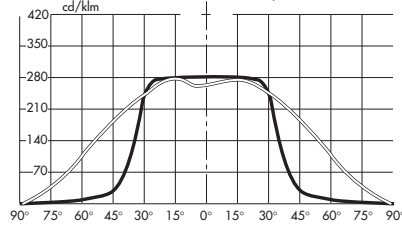
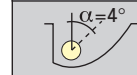
**CORUS**

Halogenuros metálicos con quemador cerámico 70 W
Reflector 1530 liso
Protector: vidrio plano
I max/2 : 2 x 4° / 2 x 40°
I max : 1150 cd/klm

