

ERMEC, S.L. BARCELONA  
C/ Francesc Teixidó, 22  
E-08918 Badalona  
(Spain)

Tel.: (+34) 902 450 160  
Fax: (+34) 902 433 088  
[info@ermec.com](mailto:info@ermec.com)  
[www.ermec.com](http://www.ermec.com)

ERMEC, S.L. MADRID  
C/ Sagasta, 8, 1ª planta  
E-28004 Madrid  
(Spain)

PORTUGAL  
[portugal@ermec.com](mailto:portugal@ermec.com)  
BILBAO  
[bilbao@ermec.com](mailto:bilbao@ermec.com)

# APEM

## K range

Power rocker switches and indicators

- Wide range
- Laser etched symbols
- Illuminated or non-illuminated
- Optionally sealed to IP68



A P E M

Unique  
rocker design

**ERMEC**

[www.ermec.com](http://www.ermec.com)

Distribución de componentes  
eléctricos y electrónicos

### The K range at a glance

A range of mix and match products



**KR rocker switches**  
Attractive rugged rocker switches with more than 3.000.000 possible combinations. Custom laser etching.  
Page 3



**KL locking rocker switches**  
Available with 2 or 3 positions, with one locked position. Patented intuitive ergonomics.  
Page 12



**KI indicators**  
A complete indicator series with a wide choice of colours and a large number of LEDs. Long life expectancy.  
Page 21



**KG rocker switches**  
With a raised protection bezel preventing inadvertent actuation of the rocker.  
Page 26

Accessories - Page 34



**Hole plug**  
For future extensions.

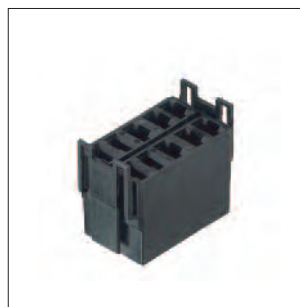

**Connector**  
For separate wiring.



**Mounting panel units**  
To limit the number of cut-outs.



**Removing tool**

APEM will be happy to develop custom product solutions. Please contact us with your requirements.



## Attractive rugged rocker switch

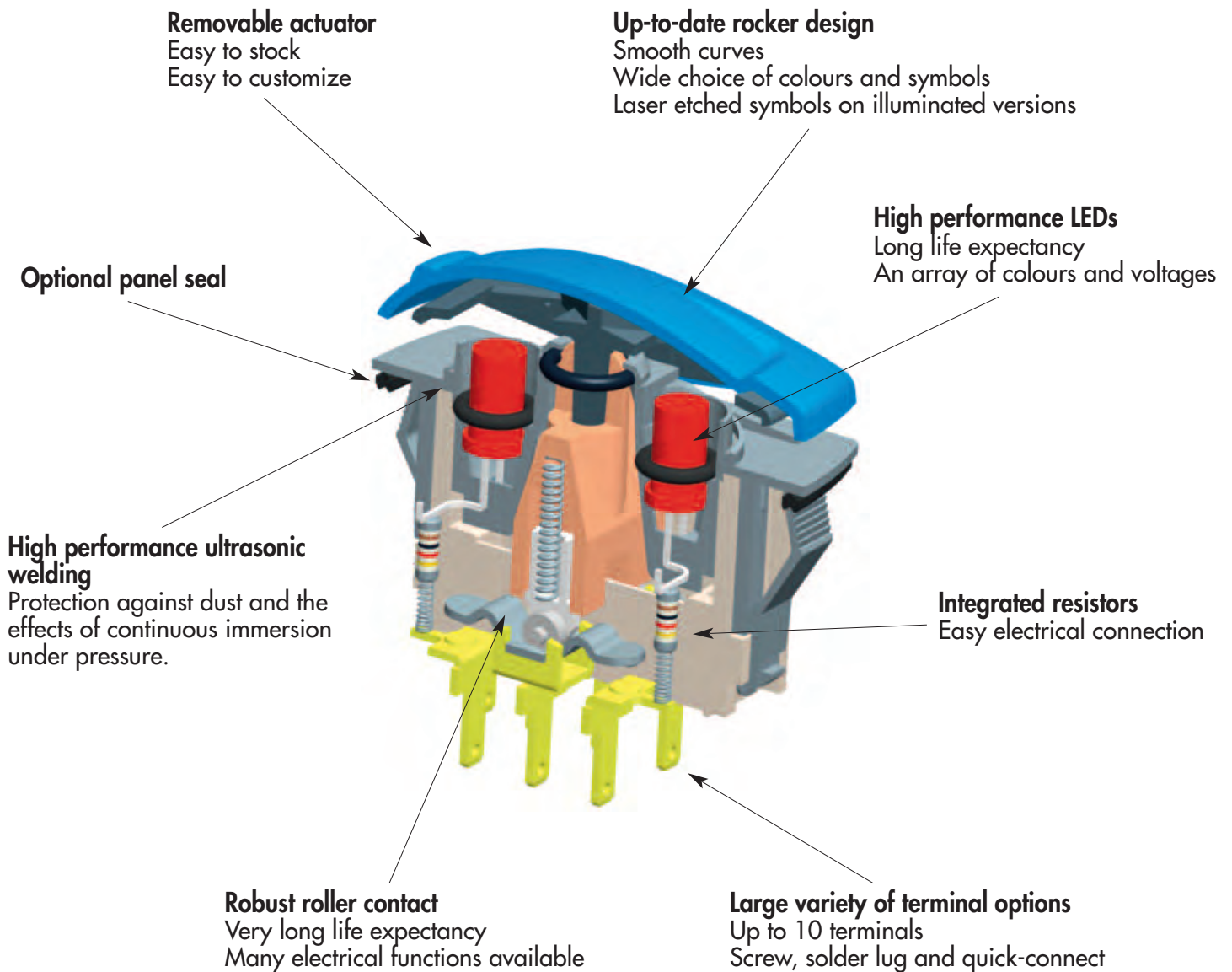

APEM will be happy to develop custom product solutions. Please contact us with your requirements.



[www.ermec.com](http://www.ermec.com)

## Power rocker switches

### Specifications



- Unique rocker design
- Wide choice of colours
- Laser etched symbols
- Illuminated or non-illuminated
- Optionally sealed to IP68

#### ELECTRICAL SPECIFICATIONS

- Current/voltage rating with resistive load :
  - Silver contacts (A) : 5A 24VDC, 100.000 cycles  
10A 24VDC, 10.000 cycles (terminals 6.35 x 0.8 only)
  - Gold plated contacts (D) : 20mA 12V, 150.000 cycles
- Initial contact resistance : 10 mΩ max.
- Insulation resistance : 1.000 MΩ min. at 500VDC
- Dielectric strength : 2.000 Vrms 50 Hz min. between terminals
- Mechanical life : 150.000 cycles min.

#### ENVIRONMENTAL SPECIFICATIONS

- Degree of protection of sealed versions : frontal sealing to IP68 according to IEC 60529 (submersion under 1 meter of water for more than 30 minutes)
- Salt spray resistance : 96 hours according to IEC 512-6, test 11f
- Vibration resistance : 10-500 Hz / 10 g per IEC 60068-2-6
- Operating temperature : -40°C to +85°C

#### MATERIALS

- Case : PA 6-6
- Actuator : ABS
- Bezel : PA 6-6
- Terminals : brass, silver plated
- Contacts : silver (A)  
or silver, gold plated (D)
- Contact roller : brass, nickel plated

#### SEALING

Sealing is optional.  
To order a sealed product, complete the appropriate box of ordering format on the following pages.

#### DIMENSIONS

→ Flat seal

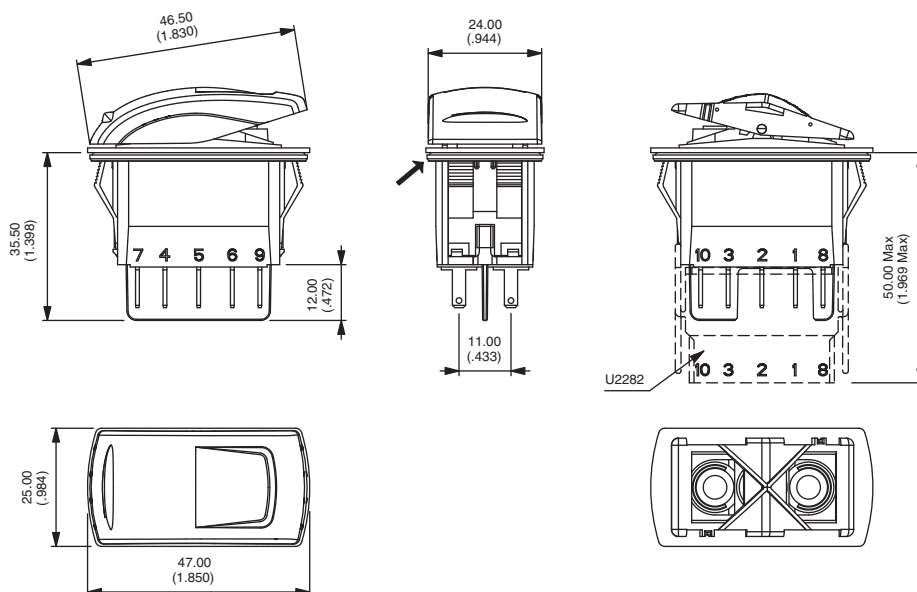

**Dimensions :** First dimensions are in mm while inches are shown as bracketed numbers.

**Tolerance :** The general tolerance for dimensions in this brochure is  $\pm 0,3$  (.012). Overall dimension tolerance is  $\pm 0,5$  (.020).



Packaging unit : 40 pieces

Dimensions, specifications and data shown in this brochure are subject to change without notice.



www.ermec.com

#### HOW TO ORDER

- To order a complete product, fill in all the boxes of the following order guide.
- To order case only (without actuator), finish your order number with the LED wiring code.
- To order actuator only (without case), begin the order number with code KRR, then follow the order format from "actuator type" until the end of the options.

#### CASE + LEADS

<b>KR</b>							<b>Side A</b>	<b>Side B</b>																																																																									
<b>SERIES</b>	<b>Electrical functions</b>		<b>Contacts</b>	<b>Sealing</b>	<b>LEDS</b>		<b>Wiring</b>																																																																										
<b>Poles</b>	<table border="1"> <tr><td>1</td><td>ON</td><td>-</td><td>OFF</td></tr> <tr><td>4</td><td>ON</td><td>ON</td><td>ON</td></tr> <tr><td>4-1R</td><td>ON</td><td>ON</td><td>MOM</td></tr> <tr><td>5</td><td>MOM</td><td>-</td><td>ON</td></tr> <tr><td>6</td><td>ON</td><td>-</td><td>ON</td></tr> <tr><td>7</td><td>MOM</td><td>OFF</td><td>MOM</td></tr> <tr><td>8</td><td>ON</td><td>OFF</td><td>MOM</td></tr> <tr><td>9</td><td>ON</td><td>OFF</td><td>ON</td></tr> </table>		1	ON	-	OFF	4	ON	ON	ON	4-1R	ON	ON	MOM	5	MOM	-	ON	6	ON	-	ON	7	MOM	OFF	MOM	8	ON	OFF	MOM	9	ON	OFF	ON	<table border="1"> <tr><td>A</td><td>Silver</td></tr> <tr><td>D</td><td>Gold plated</td></tr> </table>	A	Silver	D	Gold plated	<table border="1"> <tr><td>X</td><td>No</td></tr> <tr><td>K</td><td>Yes</td></tr> </table>	X	No	K	Yes	<table border="1"> <tr><td>X</td><td>None</td></tr> <tr><td>A</td><td>LED 6V red</td></tr> <tr><td>B</td><td>LED 6V green</td></tr> <tr><td>C</td><td>LED 6V yellow</td></tr> <tr><td>M</td><td>LED 6V blue</td></tr> <tr><td>R</td><td>LED 6V white</td></tr> <tr><td>D</td><td>LED 12V red</td></tr> <tr><td>E</td><td>LED 12V green</td></tr> <tr><td>F</td><td>LED 12V yellow</td></tr> <tr><td>N</td><td>LED 12V blue</td></tr> <tr><td>S</td><td>LED 12V white</td></tr> <tr><td>J</td><td>LED 24V red</td></tr> <tr><td>K</td><td>LED 24V green</td></tr> <tr><td>L</td><td>LED 24V yellow</td></tr> <tr><td>P</td><td>LED 24V blue</td></tr> <tr><td>T</td><td>LED 24V white</td></tr> </table>		X	None	A	LED 6V red	B	LED 6V green	C	LED 6V yellow	M	LED 6V blue	R	LED 6V white	D	LED 12V red	E	LED 12V green	F	LED 12V yellow	N	LED 12V blue	S	LED 12V white	J	LED 24V red	K	LED 24V green	L	LED 24V yellow	P	LED 24V blue	T	LED 24V white	See diagrams page 9.		
1	ON	-	OFF																																																																														
4	ON	ON	ON																																																																														
4-1R	ON	ON	MOM																																																																														
5	MOM	-	ON																																																																														
6	ON	-	ON																																																																														
7	MOM	OFF	MOM																																																																														
8	ON	OFF	MOM																																																																														
9	ON	OFF	ON																																																																														
A	Silver																																																																																
D	Gold plated																																																																																
X	No																																																																																
K	Yes																																																																																
X	None																																																																																
A	LED 6V red																																																																																
B	LED 6V green																																																																																
C	LED 6V yellow																																																																																
M	LED 6V blue																																																																																
R	LED 6V white																																																																																
D	LED 12V red																																																																																
E	LED 12V green																																																																																
F	LED 12V yellow																																																																																
N	LED 12V blue																																																																																
S	LED 12V white																																																																																
J	LED 24V red																																																																																
K	LED 24V green																																																																																
L	LED 24V yellow																																																																																
P	LED 24V blue																																																																																
T	LED 24V white																																																																																
<table border="1"> <tr><td>3</td><td>Single pole</td></tr> <tr><td>4</td><td>Double pole</td></tr> </table>	3	Single pole	4	Double pole			<b>Terminals</b>	<b>Terminals (continued)</b>																																																																									
3	Single pole																																																																																
4	Double pole																																																																																
		<table border="1"> <tr><td>0</td><td>6 terminals with barrier</td></tr> <tr><td>2</td><td>6 terminals with barrier</td></tr> <tr><td>4</td><td>6 terminals w/o barrier</td></tr> <tr><td>A</td><td>10 term. with barrier</td></tr> <tr><td>B</td><td>10 term. w/o barrier</td></tr> <tr><td>C</td><td>10 terminals for use with connector U2292</td></tr> <tr><td>Quick-connect 6,35x0,8</td><td>3 6 terminals with barrier</td></tr> </table>		0	6 terminals with barrier	2	6 terminals with barrier	4	6 terminals w/o barrier	A	10 term. with barrier	B	10 term. w/o barrier	C	10 terminals for use with connector U2292	Quick-connect 6,35x0,8	3 6 terminals with barrier	<table border="1"> <tr><td>5</td><td>6 terminals w/o barrier</td></tr> <tr><td>D</td><td>10 term. with barrier</td></tr> <tr><td>E</td><td>10 term. w/o barrier</td></tr> <tr><td>F</td><td>10 term. for use with connector U2292</td></tr> <tr><td>Quick-connect 2,8x0,8</td><td>G 10 term. with barrier</td></tr> <tr><td>H</td><td>10 term. w/o barrier</td></tr> <tr><td>J</td><td>10 terminals for use with connector U2282</td></tr> </table>		5	6 terminals w/o barrier	D	10 term. with barrier	E	10 term. w/o barrier	F	10 term. for use with connector U2292	Quick-connect 2,8x0,8	G 10 term. with barrier	H	10 term. w/o barrier	J	10 terminals for use with connector U2282																																																
0	6 terminals with barrier																																																																																
2	6 terminals with barrier																																																																																
4	6 terminals w/o barrier																																																																																
A	10 term. with barrier																																																																																
B	10 term. w/o barrier																																																																																
C	10 terminals for use with connector U2292																																																																																
Quick-connect 6,35x0,8	3 6 terminals with barrier																																																																																
5	6 terminals w/o barrier																																																																																
D	10 term. with barrier																																																																																
E	10 term. w/o barrier																																																																																
F	10 term. for use with connector U2292																																																																																
Quick-connect 2,8x0,8	G 10 term. with barrier																																																																																
H	10 term. w/o barrier																																																																																
J	10 terminals for use with connector U2282																																																																																

#### ACTUATOR

<b>Type</b>	<b>Colour</b>																								
<table border="1"> <tr><td>1</td><td>For non-illuminated application</td></tr> <tr><td>2</td><td>For illuminated application</td></tr> </table>	1	For non-illuminated application	2	For illuminated application	<table border="1"> <tr><td>1</td><td>Blue</td></tr> <tr><td>1/4</td><td>Dark blue</td></tr> <tr><td>2</td><td>Black</td></tr> <tr><td>3</td><td>Green</td></tr> <tr><td>4</td><td>Grey</td></tr> <tr><td>5</td><td>Yellow</td></tr> <tr><td>6</td><td>Red</td></tr> <tr><td>7</td><td>Ivory</td></tr> <tr><td>9</td><td>Orange</td></tr> <tr><td>A</td><td>Aluminium bright</td></tr> </table>	1	Blue	1/4	Dark blue	2	Black	3	Green	4	Grey	5	Yellow	6	Red	7	Ivory	9	Orange	A	Aluminium bright
1	For non-illuminated application																								
2	For illuminated application																								
1	Blue																								
1/4	Dark blue																								
2	Black																								
3	Green																								
4	Grey																								
5	Yellow																								
6	Red																								
7	Ivory																								
9	Orange																								
A	Aluminium bright																								

#### ACTUATOR MARKING

	<b>Area A</b>	<b>Area M</b>	<b>Area B</b>									
<b>Orientation</b>	<b>Symbols</b>											
<table border="1"> <tr><td>N</td><td></td></tr> <tr><td>O</td><td></td></tr> <tr><td>S</td><td></td></tr> <tr><td>E</td><td></td></tr> </table>	N		O		S		E		<table border="1"> <tr><td></td></tr> </table>			
N												
O												
S												
E												
	<p><b>Symbols</b> : see page 31.  <b>Accessories</b> : see page 34.</p>											



**NOTICE** : please note that not all combinations of above numbers are available. Refer to the following pages for further information.



## Power rocker switches

### Case

- To order case only (without rocker), finish your order number with the LED wiring code.

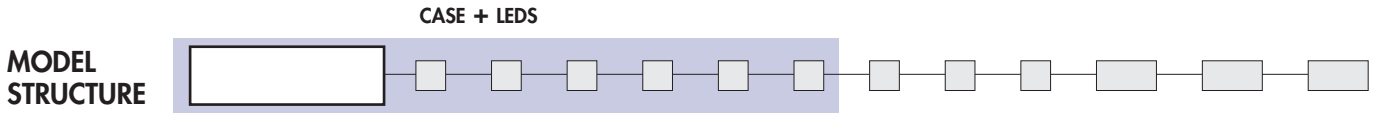



		2-3		1-2
		5-6		4-5
Single pole	Double pole			
<b>KR31</b>	<b>KR41</b>	ON	-	OFF
	<b>KR44*</b>	ON	ON	ON
	<b>KR44-1R*</b>	ON	ON	MOM
<b>KR35</b>	<b>KR45</b>	MOM	-	ON
<b>KR36</b>	<b>KR46</b>	ON	-	ON
<b>KR37</b>	<b>KR47</b>	MOM	OFF	MOM
<b>KR38</b>	<b>KR48</b>	ON	OFF	MOM
<b>KR39</b>	<b>KR49</b>	ON	OFF	ON

\* Function 4 : single pole in double pole case

Bottom view

Contact area

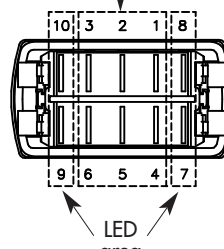

LED area

10 terminal version

Contact & LED area

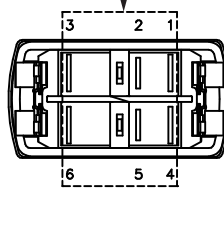









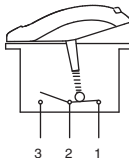
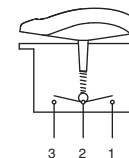
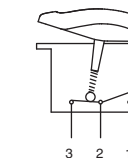
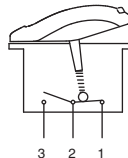
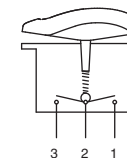
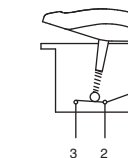
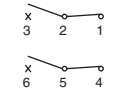

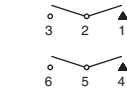
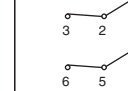
6 terminal version

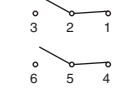
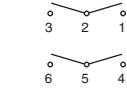
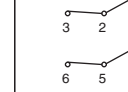
### ELECTRICAL FUNCTIONS AND CONNECTIONS

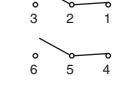
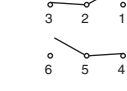
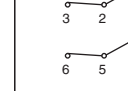
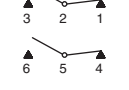
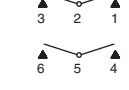
In the tables below, terminal connections as viewed from bottom of switch.  
Only the contact area is represented.  
For single pole models, only terminals 1, 2 and 3 are to be considered (not terminals 6, 5, 4).

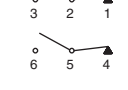
x = w/o terminal  
o = with terminal  
▲ = momentary

	Positions				Positions		
							
Function 1 * KR31-KR41				Function 8 KR38-KR48			
Function 5 KR35-KR45				Function 9 KR39-KR49			
Function 6 KR36-KR46				Function 4 KR44			
Function 7 KR37-KR47				Function 4-1R KR44-1R			

\* Function 1 only available for 6 terminal versions.



www.ermec.com

#### TERMINALS

CASE + LEDS

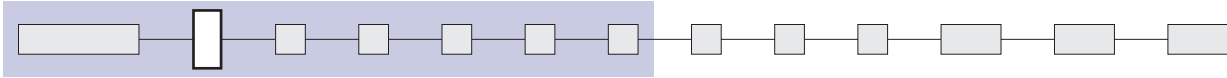

#### Screw

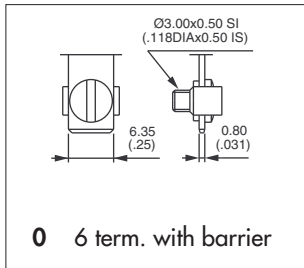

#### Solder lug / quick-connect

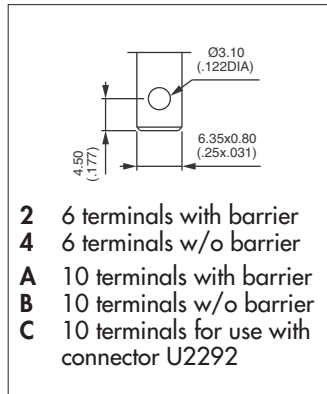

#### Normalized quick-connect 6,35x0,8

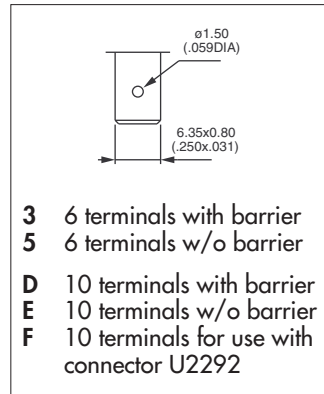

#### Normalized quick-connect 2,8x0,8

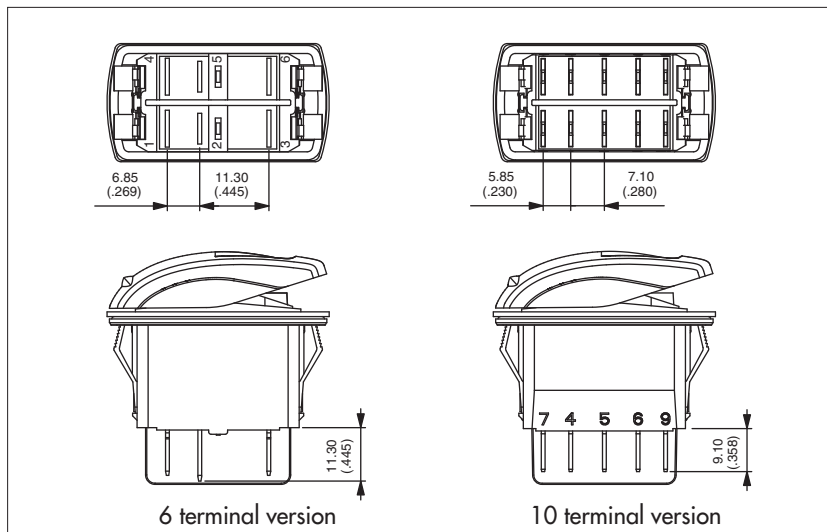
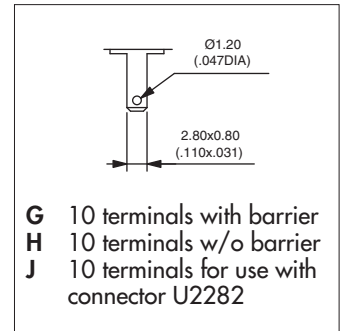

Terminals are marked on the case.

The drawings show the maximum possible number of terminals.

#### CONTACT MATERIALS

CASE + LEDS

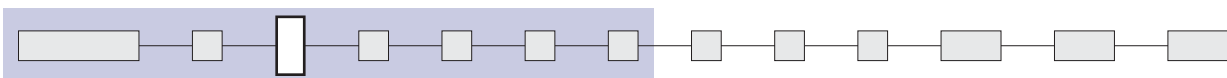

- A** Silver
- D** Silver, gold plated

## Power rocker switches

### Case - LEDs

#### SEALING

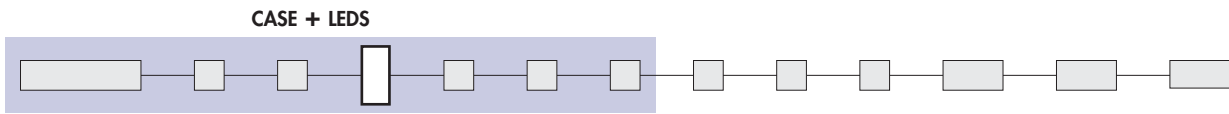

**X** No sealing

**K** IP68 (switch assembled on panel)

Ultrasonic welding of frame to case is standard on all versions.  
The ultrasonic welding and the optional panel seal prevent water and dust from introducing into the switch housing.

*The product shall be installed professionally.  
Test conditions available on request.*

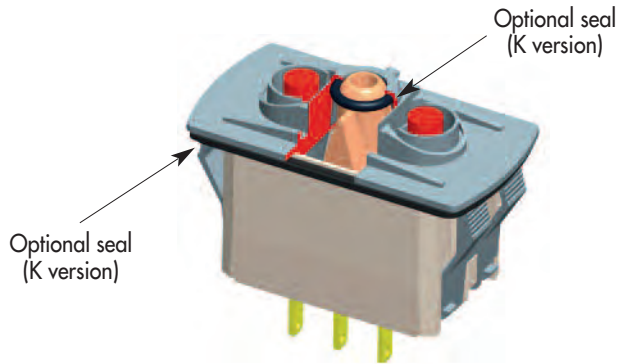

#### LEDS

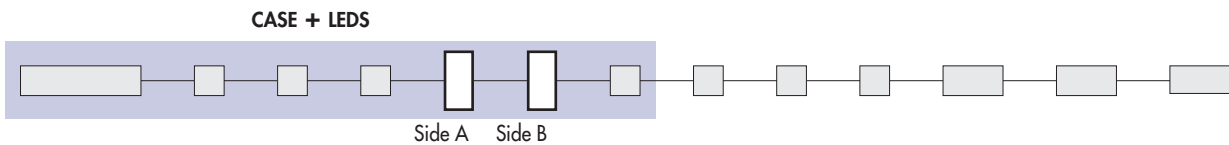

Complete each enlarged box with one of the codes listed below.

**X** Without LED

	Red	Green	Yellow	Blue	White
6VDC	<b>A</b>	<b>B</b>	<b>C</b>	<b>M</b>	<b>R</b>
12VDC	<b>D</b>	<b>E</b>	<b>F</b>	<b>N</b>	<b>S</b>
24VDC	<b>J</b>	<b>K</b>	<b>L</b>	<b>P</b>	<b>T</b>

LED consumption : 20mA @ nominal voltage (25°C)

Other illumination solutions : on request.

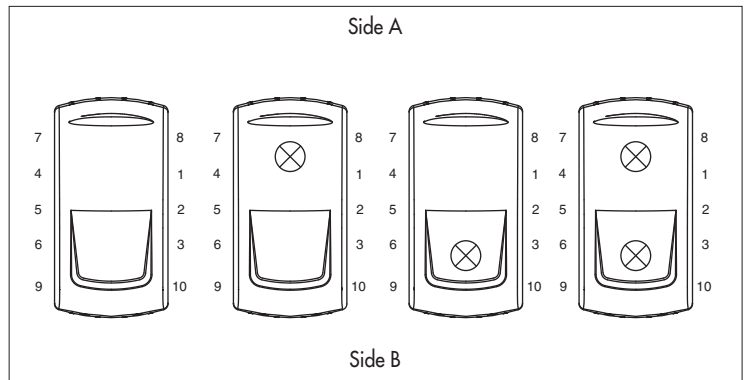

#### WIRING

The LED wiring diagram is shown on the case.

#### CASE + LEDs

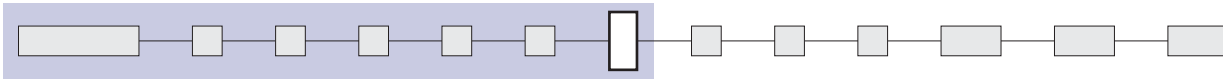

#### • For 6 terminal versions

LED connected to the load

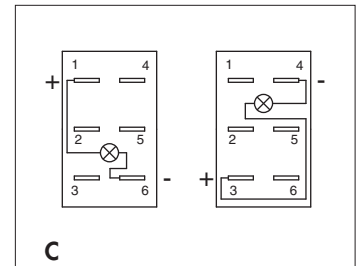
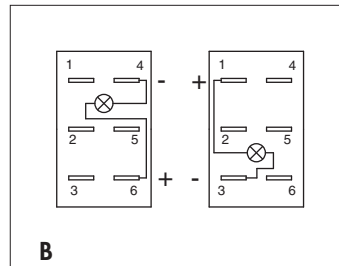
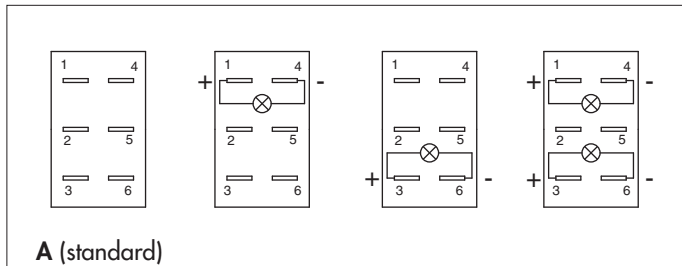

Note : If not available, terminals are added to connect the LED.

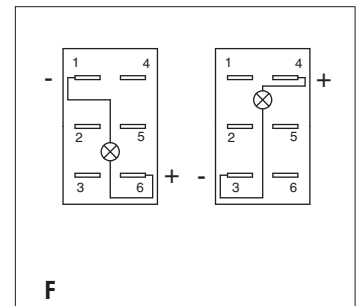
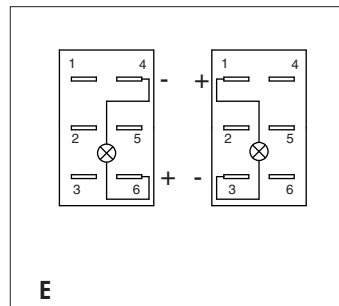
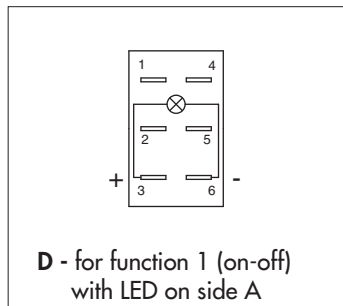

#### • For 10 terminal versions

Independent LED or integrated functions

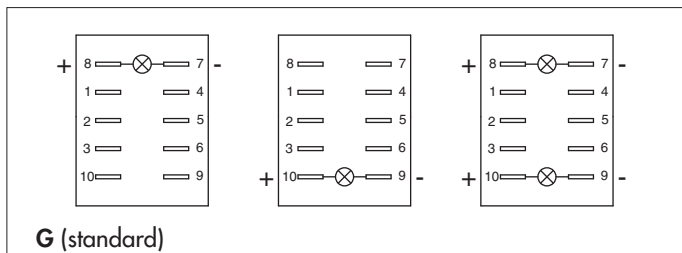

To have independent LEDs.

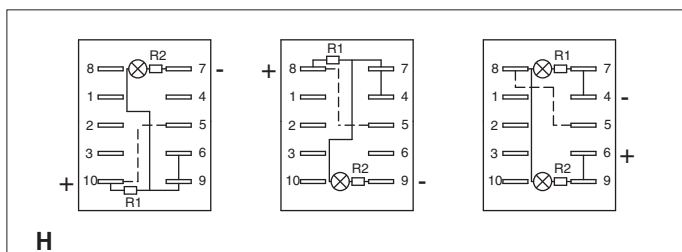

To obtain 2 symbol illumination levels (night illumination when OFF and higher illumination when ON).

*Dotted line = external wiring, continuous line = internal wiring*

Available in Single Pole only, with H and J quick-connect terminals.

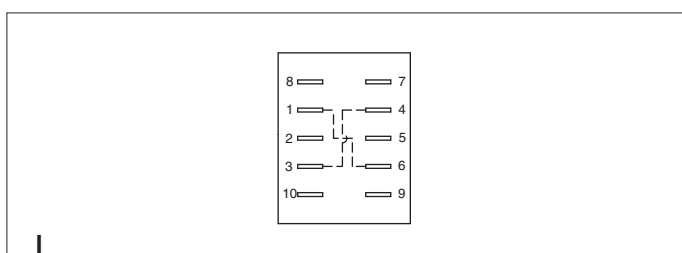

To have a polarity inversion (typical application : fan motor).

*Dotted line = internal wiring, continuous line = internal wiring*

Power supply between 2 and 5 - Load between 1 and 4 or 3 and 6. Available with H and J quick-connect terminals.

Please contact us for other wiring solutions.



www.ermec.com

## Power rocker switches

### Actuator - Marking

To order actuator only (without case), begin the order number with code KRR, then follow the order format from "actuator type" until the end of the options.

#### ACTUATOR TYPE

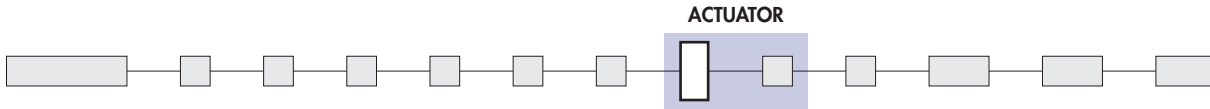

- 1 For non-illuminated application
  - 2 For illuminated application
- Other rocker design : on request.

#### ACTUATOR COLOUR

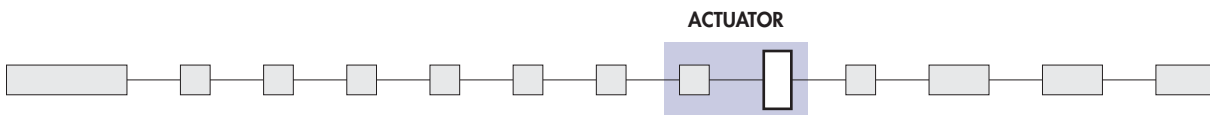

Code	Colour
1	Blue
1/4	Dark blue
2	Black
3	Green

Code	Colour
4	Grey
5	Yellow
6	Red
7	Ivory

Code	Colour
9	Orange
A	Aluminium bright

Note : colour 7 not available on illuminated versions.

A **soft-touch varnish** can be added. Consult us.



#### MARKING ORIENTATION

If no marking required, leave box blank.

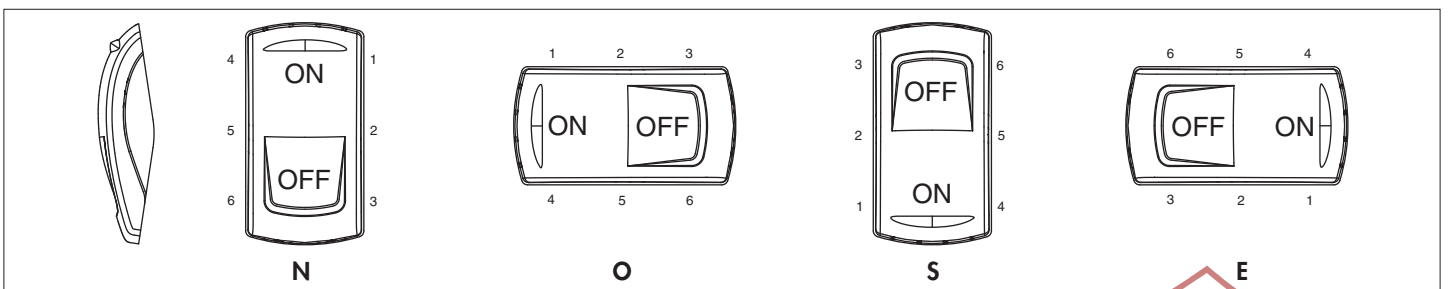
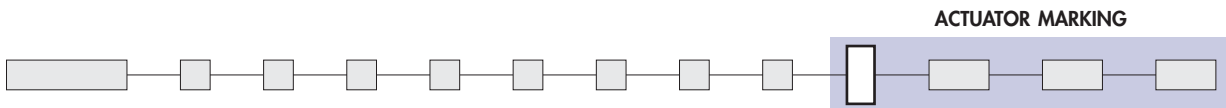

Other orientations : on request



#### SYMBOLS

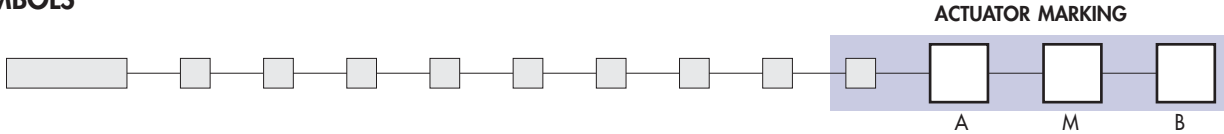

Available symbols : see page 31.

#### Marking colour

White marking for illuminated rockers (laser etching) and non-illuminated black rockers (pad printing). Black marking for non-illuminated colour rockers (pad printing). Other : on request.

#### Laser etching resistance

- Water and petrol resistant according to EN61058-1
- Tear resistant (cross-cut test) according to NF ISO 2409 : class 0
- UV resistant according to ISO 4892-2

#### Marking area

For illuminated versions. The symbol will be included in the hatched area.

Marking in M are : on request.

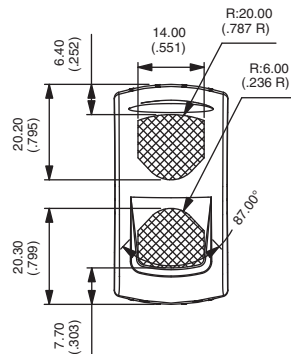
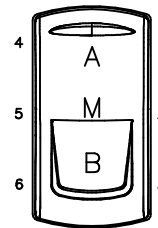

#### SWITCH PANEL CUT-OUT

Panel thickness : 0,8 mm to 4,6 mm  
Recommended panel thickness :  
between 2 mm and 3,5 mm

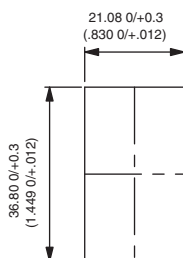

#### MATRIX MOUNTING

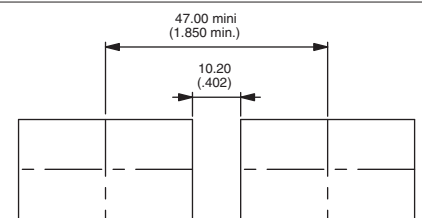
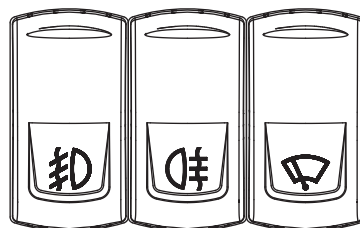
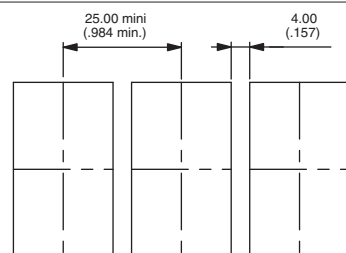

## Locking rocker switches

### Distinctive features

#### Unlocking actuator

Each KL rocker switch includes an unlocking actuator.

This actuator must be pressed to activate the protected function of the rocker. Moreover, two frames protect the unlocking actuator from untimely activation.

This intuitive and secured ergonomics is patented by APEM.

Unlocking actuator      Protection frames



#### 2 position versions (electrical functions 1, 5 and 6)

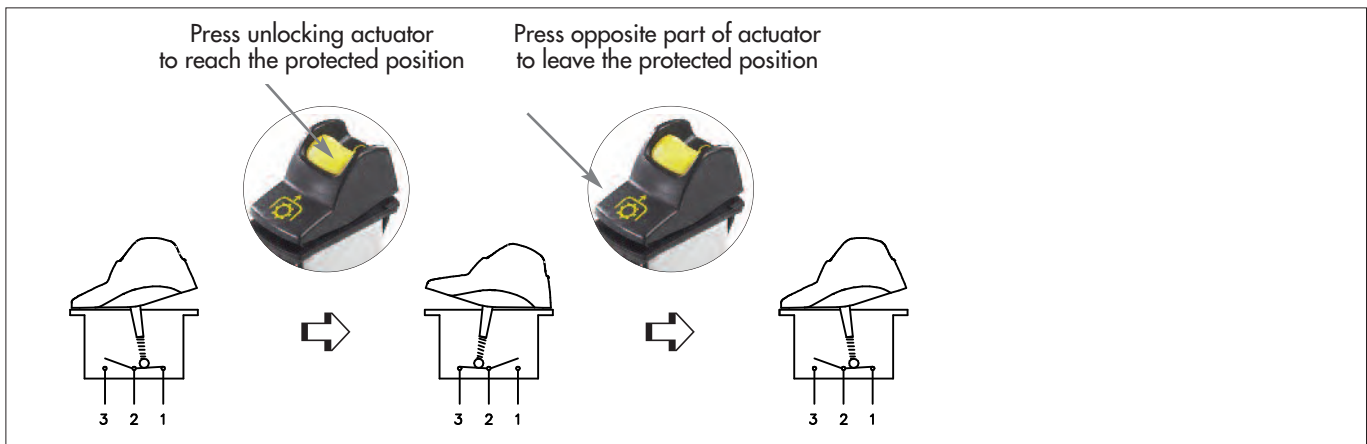

#### 3 position versions (electrical functions 7, 8, 9 4, 4-1R)

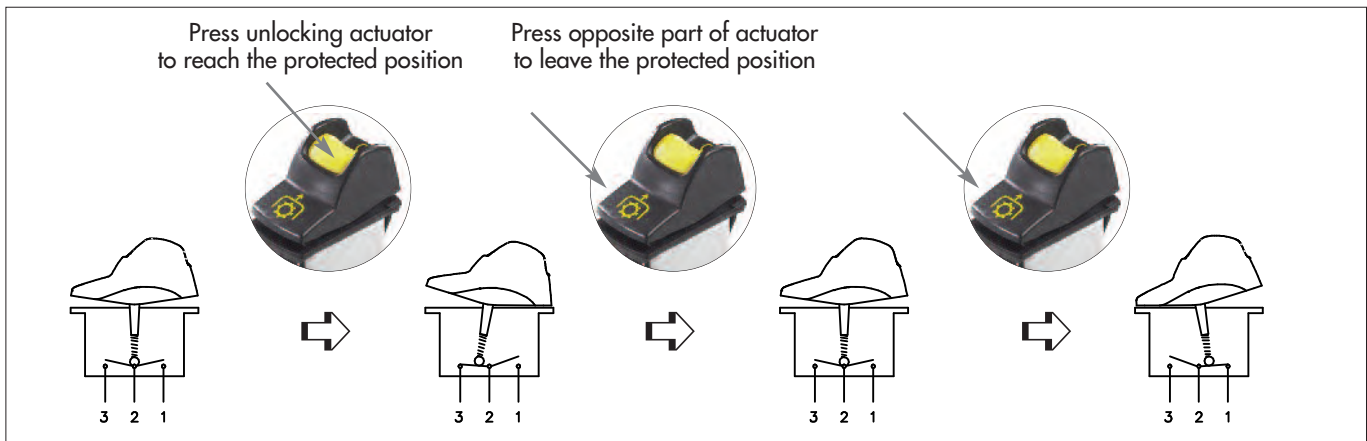



- One protected position
- Patented intuitive ergonomics
- Wide choice of colours
- Laser etched symbols
- Illuminated or non-illuminated

#### ELECTRICAL SPECIFICATIONS

- Current/voltage rating with resistive load :
  - Silver contacts (A) : 5A 24VDC, 100.000 cycles  
10A 24VDC, 10.000 cycles (terminals 6.35 x 0.8 only)
  - Gold plated contacts (D) : 20mA 12V, 150.000 cycles
- Initial contact resistance : 10 mΩ max.
- Insulation resistance : 1.000 MΩ min. at 500VDC
- Dielectric strength : 2.000 Vrms 50 Hz min. between terminals
- Mechanical life : 150.000 cycles min.

#### MATERIALS

- Case : PA 6-6
- Actuator and unlocking actuator : ABS
- Bezel : PA 6-6
- Terminals : brass, silver plated
- Contacts : silver (A)  
or silver, gold plated (D)
- Contact roller : brass, nickel plated

#### ENVIRONMENTAL SPECIFICATIONS

- Degree of protection of sealed versions : frontal sealing to IP68 according to IEC 60529 (submersion under 1 meter of water for more than 30 minutes)
- Salt spray resistance : 96 hours according to IEC 512-6, test 11f
- Operating temperature : -40°C to +85°C

#### SEALING

Sealing is optional.

To order a sealed product, complete the appropriate box of ordering format on the following pages.

#### DIMENSIONS

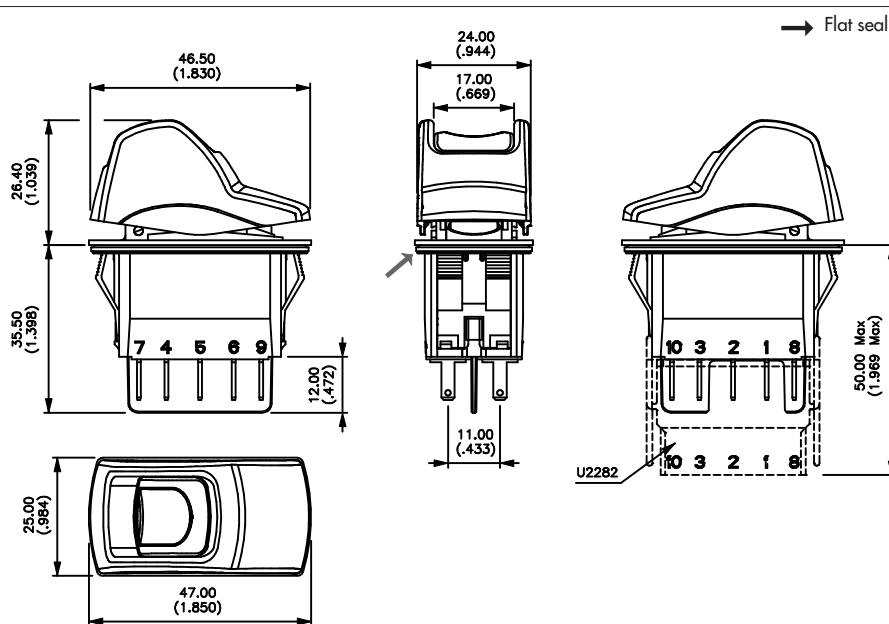

**Dimensions :** First dimensions are in mm while inches are shown as bracketed numbers.

**Tolerance :** The general tolerance for dimensions in this brochure is  $\pm 0,3$  (.012). Overall dimension tolerance is  $\pm 0,5$  (.020).



Packaging unit : 40 pieces

Dimensions, specifications and data shown in this brochure are subject to change without notice.

## Locking rocker switches

### Selection guide

• To order a complete product, fill in all the boxes of the following order guide.

#### CASE + LEDS

<b>KL</b>							<b>Side B</b>																																																																	
<b>SERIES</b>	<b>Electrical functions</b>			<b>Contacts</b>	<b>Sealing</b>	<b>LEDS</b>		<b>Wiring</b>																																																																
<b>Poles</b>	<table border="1"> <tr><td>1</td><td>ON</td><td>-</td><td>OFF</td></tr> <tr><td>4</td><td>ON</td><td>ON</td><td>ON</td></tr> <tr><td>4-1R</td><td>ON</td><td>ON</td><td>MOM</td></tr> <tr><td>5</td><td>MOM</td><td>-</td><td>ON</td></tr> <tr><td>6</td><td>ON</td><td>-</td><td>ON</td></tr> <tr><td>7</td><td>MOM</td><td>OFF</td><td>MOM</td></tr> <tr><td>8</td><td>ON</td><td>OFF</td><td>MOM</td></tr> <tr><td>9</td><td>ON</td><td>OFF</td><td>ON</td></tr> </table>			1	ON	-	OFF	4	ON	ON	ON	4-1R	ON	ON	MOM	5	MOM	-	ON	6	ON	-	ON	7	MOM	OFF	MOM	8	ON	OFF	MOM	9	ON	OFF	ON	<b>A</b> Silver <b>D</b> Gold plated	<b>X</b> No <b>K</b> Yes	<table border="1"> <tr><td>X</td><td>None</td></tr> <tr><td>A</td><td>LED 6V red</td></tr> <tr><td>B</td><td>LED 6V green</td></tr> <tr><td>C</td><td>LED 6V yellow</td></tr> <tr><td>M</td><td>LED 6V blue</td></tr> <tr><td>R</td><td>LED 6V white</td></tr> <tr><td>D</td><td>LED 12V red</td></tr> <tr><td>E</td><td>LED 12V green</td></tr> <tr><td>F</td><td>LED 12V yellow</td></tr> <tr><td>N</td><td>LED 12V blue</td></tr> <tr><td>S</td><td>LED 12V white</td></tr> <tr><td>J</td><td>LED 24V red</td></tr> <tr><td>K</td><td>LED 24V green</td></tr> <tr><td>L</td><td>LED 24V yellow</td></tr> <tr><td>P</td><td>LED 24V blue</td></tr> <tr><td>T</td><td>LED 24V white</td></tr> </table>		X	None	A	LED 6V red	B	LED 6V green	C	LED 6V yellow	M	LED 6V blue	R	LED 6V white	D	LED 12V red	E	LED 12V green	F	LED 12V yellow	N	LED 12V blue	S	LED 12V white	J	LED 24V red	K	LED 24V green	L	LED 24V yellow	P	LED 24V blue	T	LED 24V white	See diagrams page 18.
1	ON	-	OFF																																																																					
4	ON	ON	ON																																																																					
4-1R	ON	ON	MOM																																																																					
5	MOM	-	ON																																																																					
6	ON	-	ON																																																																					
7	MOM	OFF	MOM																																																																					
8	ON	OFF	MOM																																																																					
9	ON	OFF	ON																																																																					
X	None																																																																							
A	LED 6V red																																																																							
B	LED 6V green																																																																							
C	LED 6V yellow																																																																							
M	LED 6V blue																																																																							
R	LED 6V white																																																																							
D	LED 12V red																																																																							
E	LED 12V green																																																																							
F	LED 12V yellow																																																																							
N	LED 12V blue																																																																							
S	LED 12V white																																																																							
J	LED 24V red																																																																							
K	LED 24V green																																																																							
L	LED 24V yellow																																																																							
P	LED 24V blue																																																																							
T	LED 24V white																																																																							
3 Single pole 4 Double pole				<b>Terminals</b>	<b>Terminals (continued)</b>																																																																			
				<b>Screw</b>	<b>Quick-connect 6,35x0,8</b>																																																																			
				0 6 terminals with barrier	5 6 terminals w/o barrier																																																																			
				<b>Solder lug/quick-connect</b>	<b>D</b> 10 term. with barrier																																																																			
				2 6 terminals with barrier	<b>E</b> 10 term. w/o barrier																																																																			
				4 6 terminals w/o barrier	<b>F</b> 10 term. for use with connector U2292																																																																			
				<b>A</b> 10 term. with barrier	<b>Quick-connect 2,8x0,8</b>																																																																			
				<b>B</b> 10 term. w/o barrier	<b>G</b> 10 term. with barrier																																																																			
				<b>C</b> 10 terminals for use with connector U2292	<b>H</b> 10 term. w/o barrier																																																																			
				<b>Quick-connect 6,35x0,8</b>	<b>J</b> 10 terminals for use with connector U2282																																																																			
				3 6 terminals with barrier																																																																				

#### ACTUATOR

<b>Type</b>	<b>Rocker colour</b>	<b>Unlocking actuator colour</b>
1 For non-illum. application 2 For illuminated application	1 Blue 1/4 Dark blue 2 Black 3 Green 4 Grey 5 Yellow 6 Red 7 Ivory 9 Orange	1 Blue 1/4 Dark blue 2 Black 3 Green 4 Grey 5 Yellow 6 Red 7 Ivory 9 Orange

#### ACTUATOR MARKING

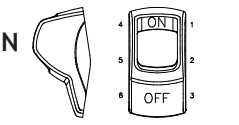
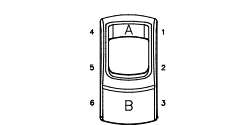
	<b>Area A</b>	<b>Area B</b>
<b>Orientation</b>	<b>Symbols</b>	<b>Marking colour</b>
		<b>Illuminated models</b> <b>Blank</b> White <b>Non-illuminated</b> 1 Blue 2 Black 3 Green 4 Grey 5 Yellow 6 Red 7 White 9 Orange
<b>Symbols</b> : see page 31. <b>Accessories</b> : see page 34.		

 **NOTICE** : please note that not all combinations of above numbers are available. Refer to the following pages for further information.

#### MODEL STRUCTURE

CASE + LEDS

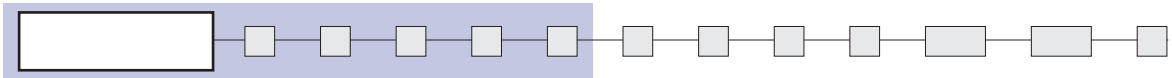

	Single pole	Double pole	2-3	1-2	5-6	4-5
KL31		KL41	ON	-	OFF	
		KL44*	ON	ON	ON	
		KL44-1R*	ON	ON	MOM	
KL35		KL45	MOM	-	ON	
KL36		KL46	ON	-	ON	
KL37		KL47	MOM	OFF	MOM	
KL38		KL48	ON	OFF	MOM	
KL39		KL49	ON	OFF	ON	

\* Function 4 : single pole in double pole case

Bottom view

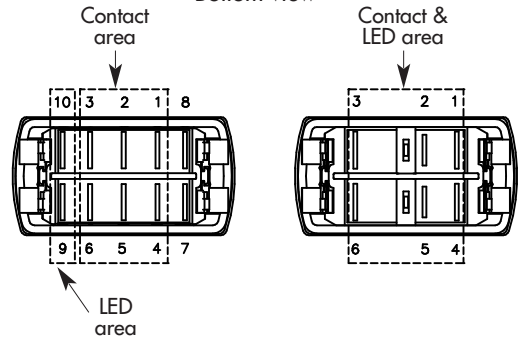

10 terminal version

6 terminal version

#### ELECTRICAL FUNCTIONS AND CONNECTIONS

In the tables below, terminal connections as viewed from bottom of switch. Only the contact area is represented. For single pole models, only terminals 1, 2 and 3 are to be considered (not 6, 5, 4).

x = w/o terminal  
o = with terminal  
▲ = momentary

	2 positions	
Function 1 * KL31-KL41		
Function 5 KL35 - KL45		
Function 6 KL36-KL46		

#### \* Function 1

- Only available for 6 terminal versions.
- Illuminated versions only available with "A" wiring.

	3 positions		
Function 7 KL37-KL47			
Function 8 KL38-KL48			
Function 9 KL39-KL49			
Function 4 KL44			
Function 4-1R KL44-1R			



www.ermec.com

## Locking rocker switches

### Case

#### TERMINALS

CASE + LEDS

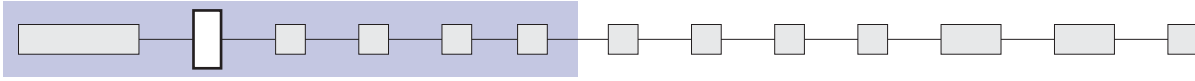

#### Screw

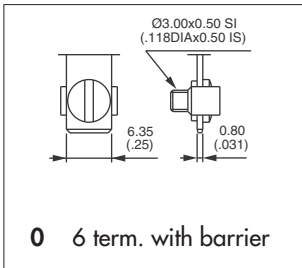

#### Solder lug / quick-connect

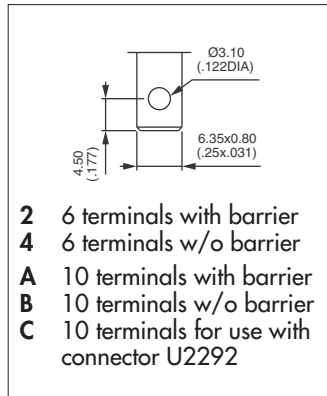

#### Normalized quick-connect 6,35x0,8

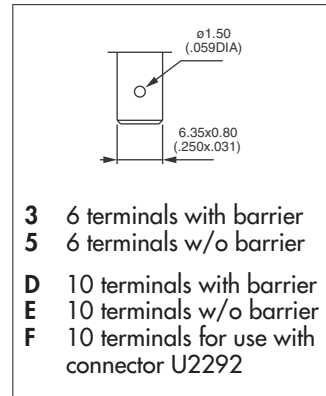

#### Normalized quick-connect 2,8x0,8

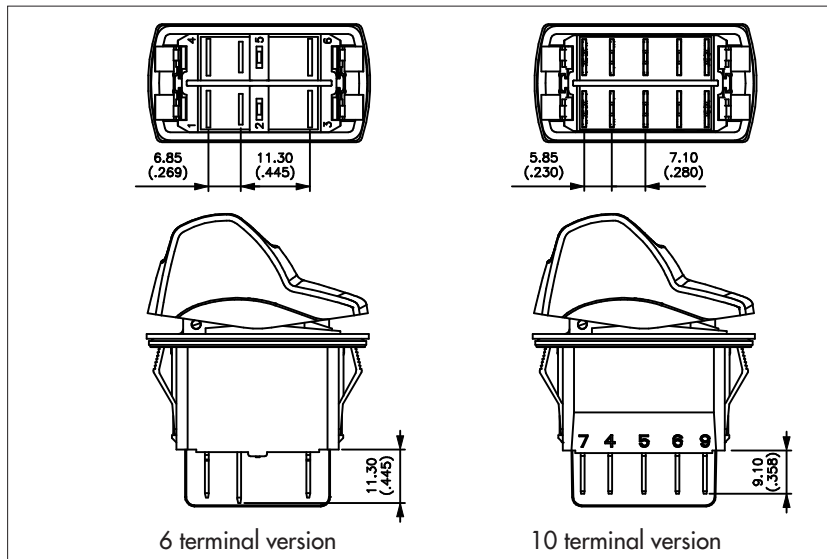
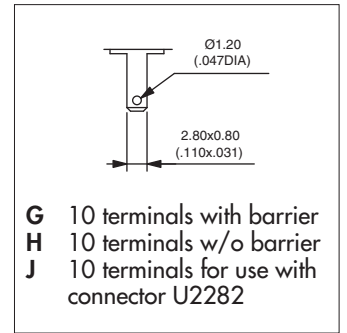

Terminals are marked on the case.

The drawings show the maximum possible number of terminals.

#### CONTACT MATERIALS

CASE + LEDS

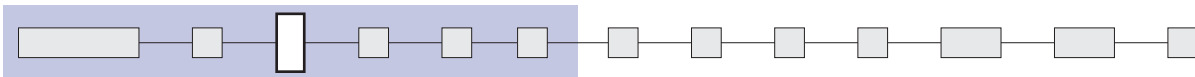

- A** Silver
- D** Silver, gold plated

#### SEALING

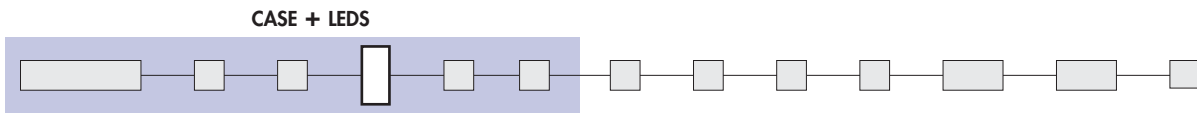

- X No sealing
- K IP68 (switch assembled on panel)

Ultrasonic welding of frame to case is standard on all versions.  
The ultrasonic welding and the optional panel seal prevent water and dust from introducing into the switch housing.

*The product shall be installed professionally.  
Test conditions available on request.*

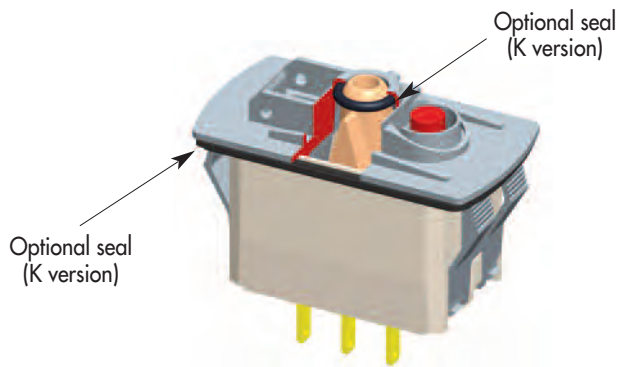

#### LEDS

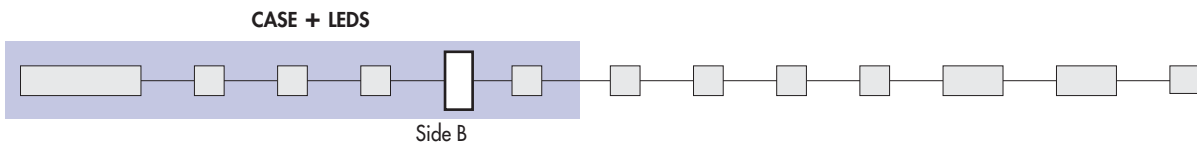

Complete enlarged box with one of the codes listed below.

- X Without LED

	Red	Green	Yellow	Blue	White
6VDC	A	B	C	M	R
12VDC	D	E	F	N	S
24VDC	J	K	L	P	T

LED consumption : 20mA @ nominal voltage (25°C)

Other illumination solutions : on request.

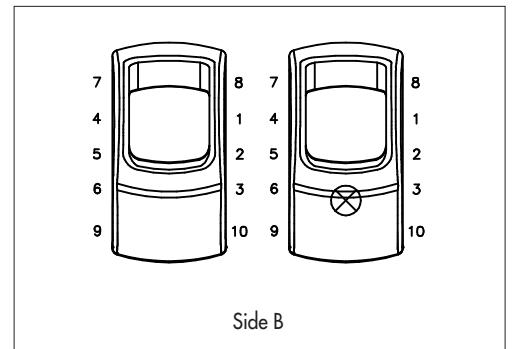

## Locking rocker switches

### Case - LED

#### WIRING

The LED wiring diagram is shown on the case.

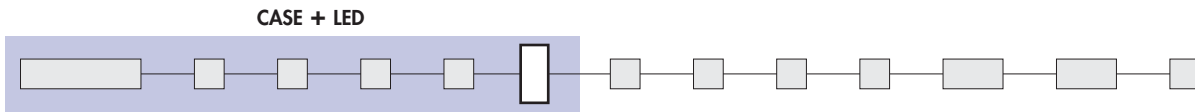

#### • For 6 terminal versions      LED connected to the load

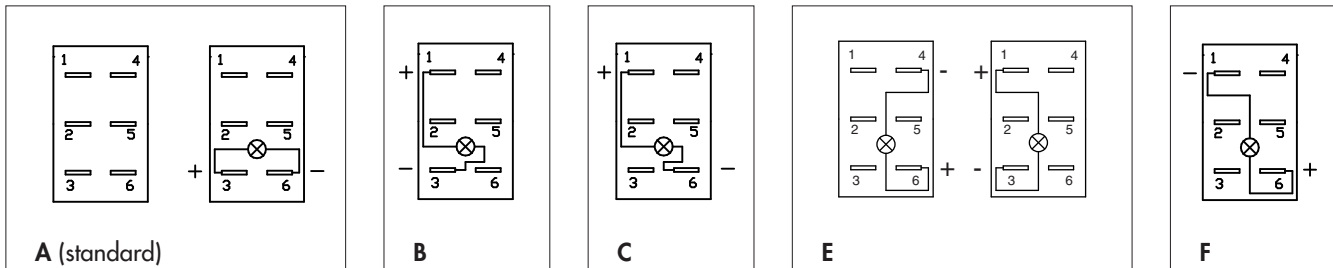

Note : If not available, terminals are added to connect the LED.

#### • For 10 terminal versions      Independent LED or integrated functions

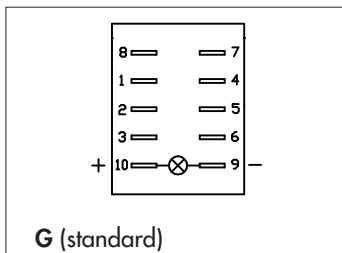

To have independent LED.

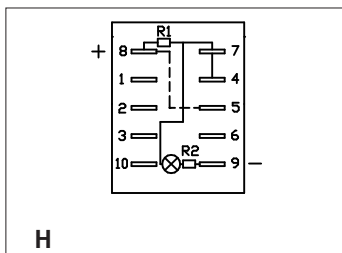

To obtain 2 symbol illumination levels (night illumination when OFF and higher illumination when ON).  
Dotted line = external wiring, continuous line = internal wiring

Available in Single Pole only, with H and J quick-connect terminals.

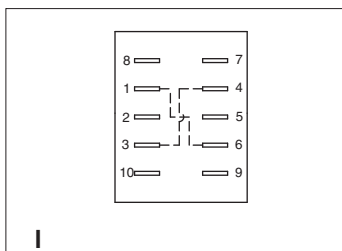

To have a polarity inversion (typical application : fan motor).  
Dotted line = internal wiring, continuous line = internal wiring

Power supply between 2 and 5 - Load between 1 and 4 or 3 and 6.  
Available with H and J quick-connect terminals.

Please contact us for other wiring solutions.

#### ACTUATOR TYPE

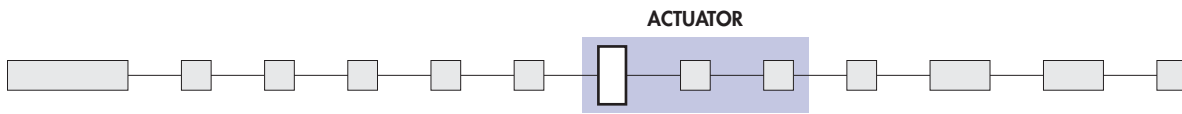

- 1 For non-illuminated application
- 2 For illuminated application

#### ROCKER COLOUR

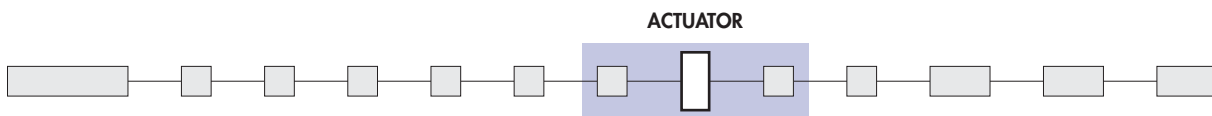

Code	Colour
1	Blue
1/4	Dark blue
2	Black

Code	Colour
3	Green
4	Grey
5	Yellow

Code	Colour
6	Red
7	Ivory
9	Orange

#### UNLOCKING ACTUATOR COLOUR

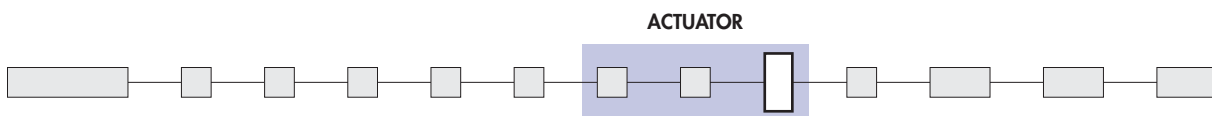

Code	Colour
1	Blue
1/4	Dark blue
2	Black

Code	Colour
3	Green
4	Grey
5	Yellow

Code	Colour
6	Red
7	Ivory
9	Orange

Note : colour 7 not available on illuminated versions

#### MARKING ORIENTATION

If no marking required, leave box blank.

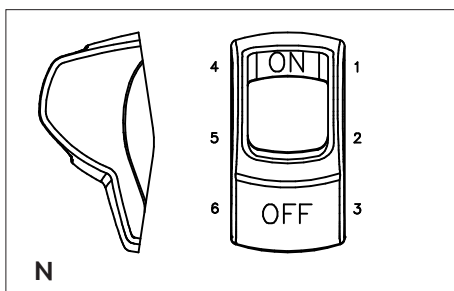
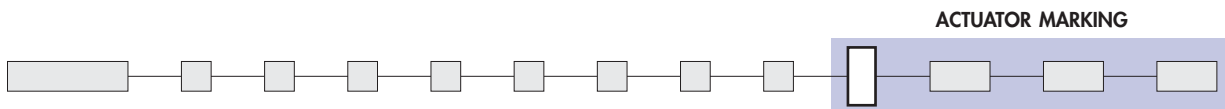

Other orientations : on request

## Locking rocker switches

### Marking - Mounting

#### SYMBOLS

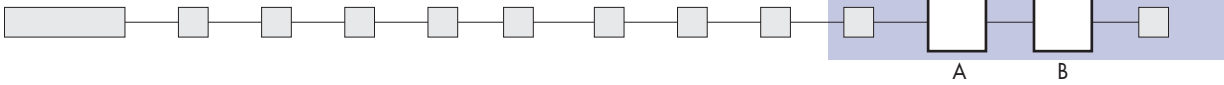

Available symbols : see page 31.

#### Laser etching resistance

- Water and petrol resistant according to EN61058-1
- Tear resistant (cross-cut test) according to NF ISO 2409 : class 0
- UV resistant according to ISO 4892-2

Marking area - The symbol will be included in the hatched area.

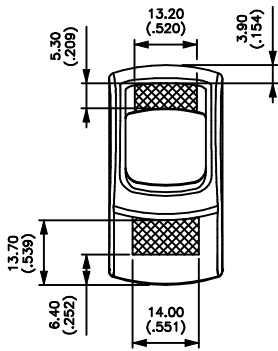
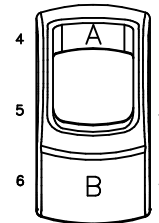

For illuminated versions

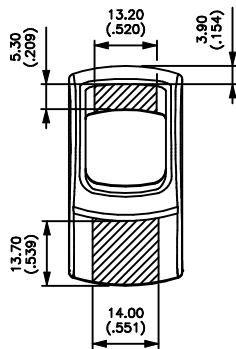

For non-illuminated versions

#### MARKING COLOUR

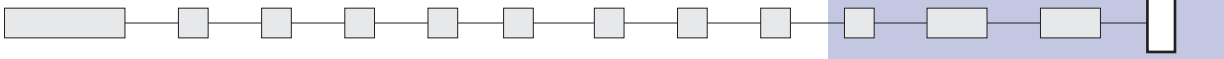

Illuminated models (laser etching)

Blank White

Non-illuminated models (pad printing)

1 : Blue - 2 : Black - 3 : Green - 4 : Grey - 5 : Yellow - 6 : Red - 7 : White - 9 : Orange

#### SWITCH PANEL CUT-OUT

Panel thickness : 0,8 mm to 4,6 mm

Recommended panel thickness :  
between 2 mm and 3,5 mm

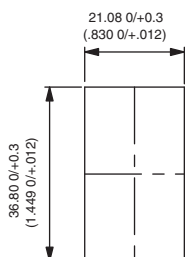

#### MATRIX MOUNTING

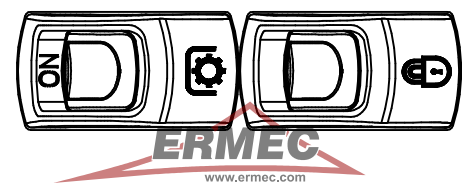
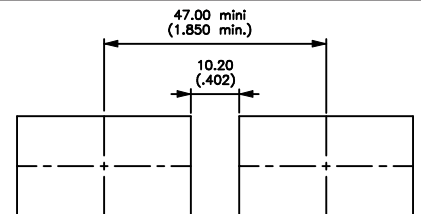
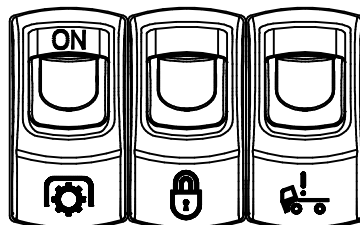
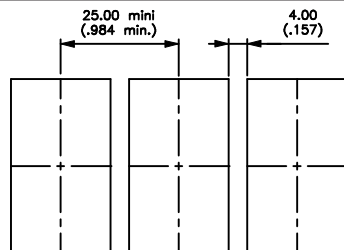



- Wide choice of bezel colours
- Wide choice of LEDs
- Laser etched symbols
- Long life expectancy

#### ELECTRICAL SPECIFICATIONS

- Operating voltage : 6VDC, 12VDC or 24VDC
- Nominal current : 20mA per LED

#### ENVIRONMENTAL SPECIFICATIONS

- Degree of protection of sealed versions : frontal sealing to IP68 according to IEC 60529 (submersion under 1 meter of water for more than 30 minutes)
- Salt spray resistance : 96 hours according to IEC 512-6, test 11f
- Operating temperature : -40°C to +85°C

#### MATERIALS

- Case : ABS
- Bezel : ABS
- Terminals : brass, silver plated

#### SEALING

Sealing is optional.  
To order a sealed product, complete the appropriate box of ordering format on the following pages.

#### DIMENSIONS

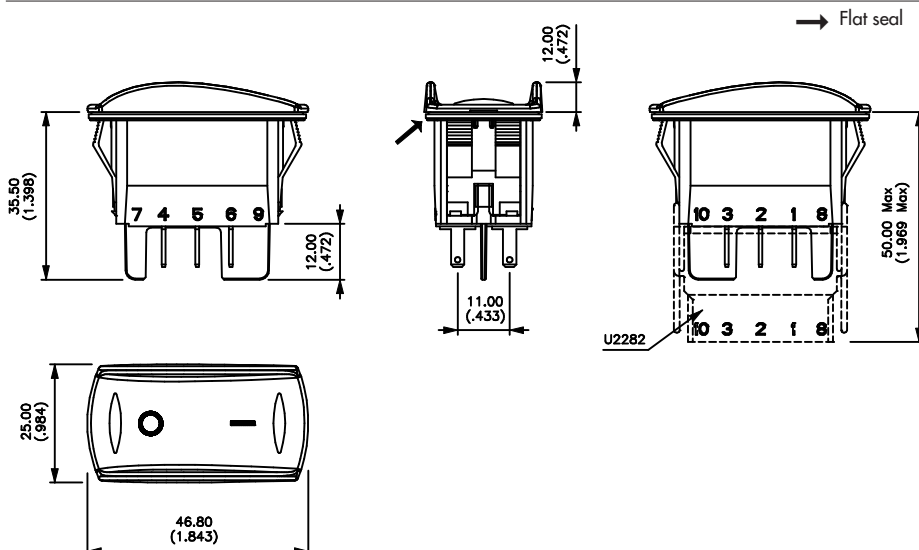

**Dimensions** : First dimensions are in mm while inches are shown as bracketed numbers.



**Tolerance** : The general tolerance for dimensions in this brochure is  $\pm 0,3$  (.012). Overall dimension tolerance is  $\pm 0,5$  (.020).



**Packaging unit** : 40 pieces

## LED indicators

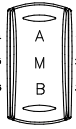
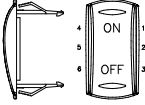
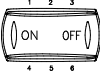
### Selection guide

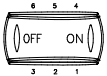
Side A	Side M	Side B	Side A	Side M	Side B
<b>SERIES</b> <b>KI</b>	<b>Colours</b> <b>1</b> Blue <b>1/4</b> Dark blue <b>2</b> Black <b>3</b> Green <b>4</b> Grey <b>5</b> Yellow <b>6</b> Red <b>9</b> Orange	<b>LEDS</b> <b>X</b> None <b>A</b> LED 6V red <b>B</b> LED 6V green <b>C</b> LED 6V yellow <b>M</b> LED 6V blue <b>R</b> LED 6V white <b>D</b> LED 12V red <b>E</b> LED 12V green <b>F</b> LED 12V yellow <b>N</b> LED 12V blue <b>S</b> LED 12V white <b>J</b> LED 24V red <b>K</b> LED 24V green <b>L</b> LED 24V yellow <b>P</b> LED 24V blue <b>T</b> LED 24V white  DC voltage standard	<b>Type of illumination</b> <b>X</b> Standard <b>S</b> Super bright	<b>Symbols</b> 	<b>Sealing</b> <b>X</b> No <b>K</b> Yes
			<b>Marking orientation</b> <b>N</b>  <b>O</b>  <b>S</b>  <b>E</b> 	<b>Terminals with barrier</b> <b>C</b> Solder lug / quick-connect <b>F</b> Quick-connect 6,35 <b>J</b> Quick-connect 2,8	

**On request** : 48VDC voltage - AC voltage - new design

**Symbols** : see page 31.

**Accessories** : see page 34.



**NOTICE** : please note that not all combinations of above numbers are available. Refer to the following pages for further information.

#### BEZEL COLOUR

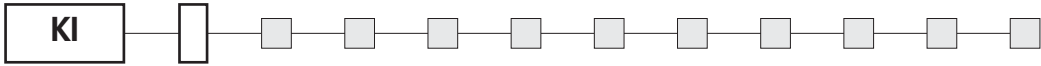

Code	Colour
1	Blue
1/4	Dark blue
2	Black
3	Green

Code	Colour
4	Grey
5	Yellow
6	Red
9	Orange

#### LEDS

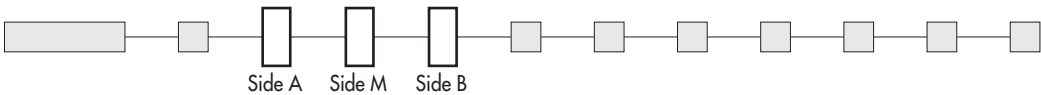

Complete each enlarged box with one of the codes listed below.

**X** Without LED

	Red	Green	Yellow	Blue	White
6VDC	<b>A</b>	<b>B</b>	<b>C</b>	<b>M</b>	<b>R</b>
12VDC	<b>D</b>	<b>E</b>	<b>F</b>	<b>N</b>	<b>S</b>
24VDC	<b>J</b>	<b>K</b>	<b>L</b>	<b>P</b>	<b>T</b>

LED consumption : 20mA @ nominal voltage (25°C)  
 Other illumination solutions : on request.

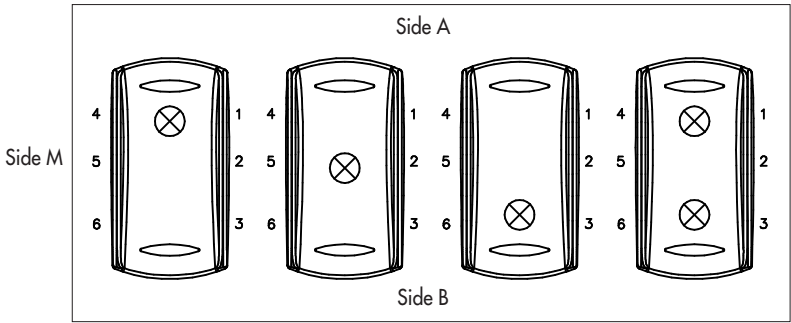

#### TYPE OF ILLUMINATION

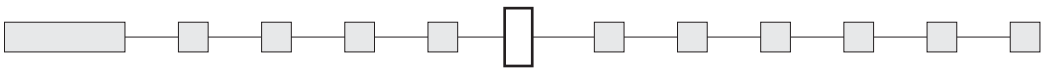

**X** Standard  
**S** Super bright

#### MARKING ORIENTATION

If no marking required, leave box blank. Other orientations : on request

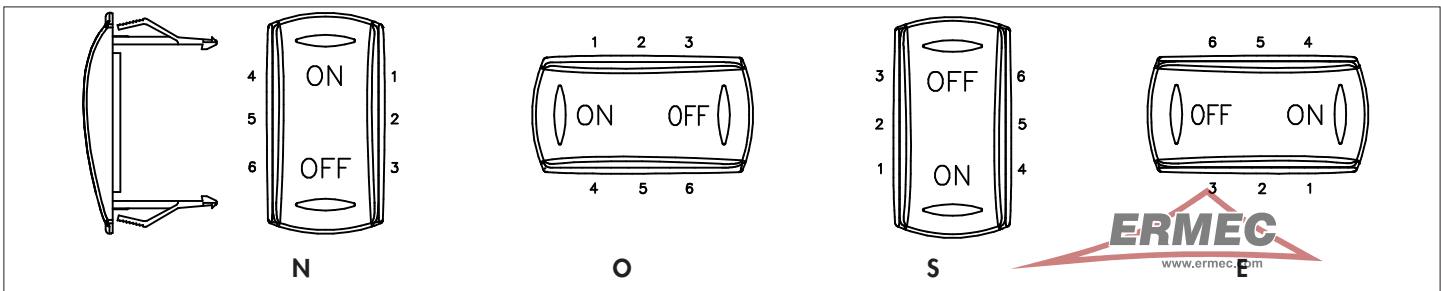
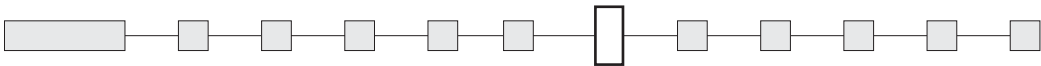

## LED indicators

### Marking - Terminals

#### SYMBOLS

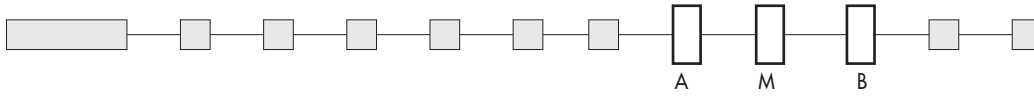

Available symbols : see page 31.

#### Marking colour

White (laser etching)

#### Laser etching resistance

- Water and petrol resistant according to EN61058-1
- Tear resistant (cross-cut test) according to NF ISO 2409 : class 0
- UV resistant according to ISO 4892-2

Marking area - The symbol will be included in the hatched area.

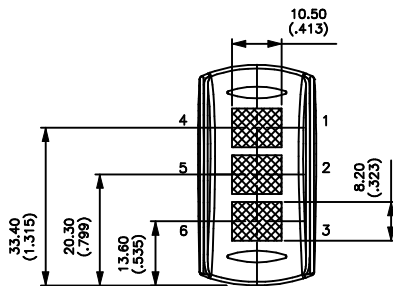
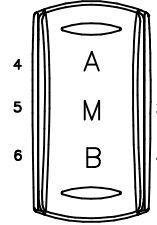

#### TERMINALS (WITH BARRIER)

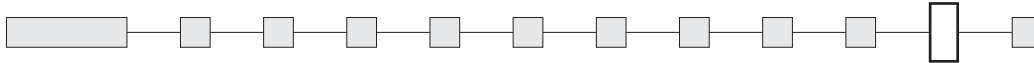

Solder lug / quick-connect

Normalized quick-connect 6,35x0,8

Normalized quick-connect 2,8x0,8

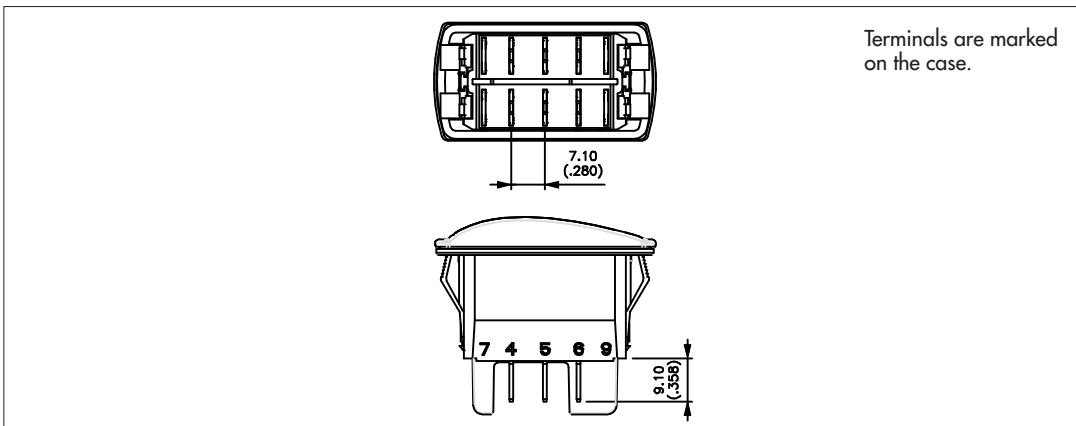
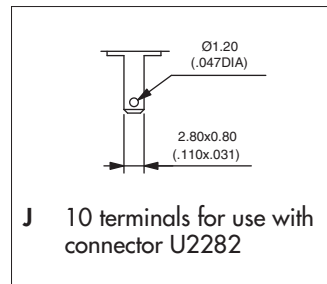
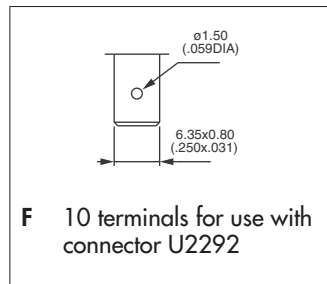
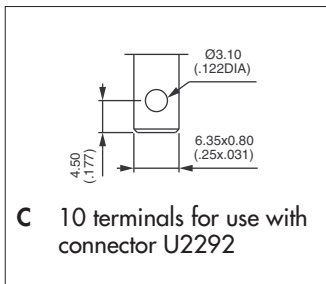

#### SEALING

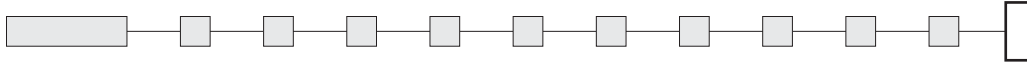

- X No sealing
- K IP68 (switch assembled on panel)

Ultrasonic welding of frame to case is standard on all versions.  
The ultrasonic welding and the optional panel seal prevent water and dust from introducing into the switch housing.

*The product shall be installed professionally.  
Test conditions available on request.*



#### SWITCH PANEL CUT-OUT

Panel thickness : 0,8 mm to 4,6 mm  
Recommended panel thickness :  
between 2 mm and 3,5 mm

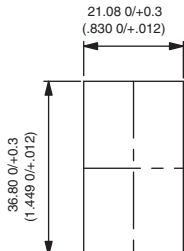

#### MATRIX MOUNTING

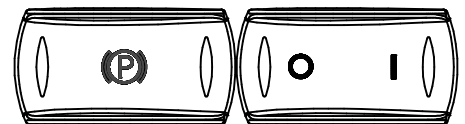
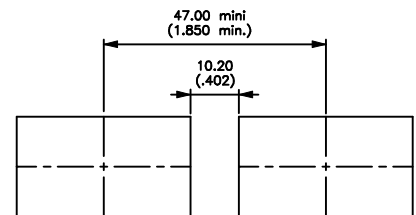
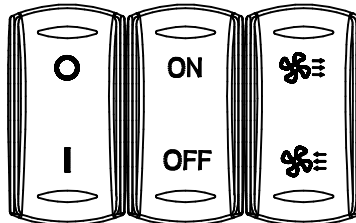
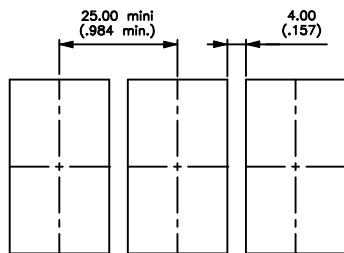

## Power rocker switches

### Distinctive features and specifications



- Protected rocker
- Illuminated or non-illuminated
- VDE (EN 61058-1) approved
- Sealed to IP65

#### ELECTRICAL SPECIFICATIONS

- Current/voltage rating :
  - functions 1 (ON-OFF) and 6 (ON-ON) : 15A 12VDC, 10A 24VDC, 15A 250VAC max., 10mA 14VDC min.
  - functions 4 (ON ON ON) and 4-1R (ON ON MOM) : 8A 12VDC, 5A 24VDC, 8A 250VAC max.
  - other functions : 10A 12VDC, 8A 24VDC, 10A 250VAC max.
- VDE approved ratings : 12(4)A 250VAC, T85/55°C
- Initial contact resistance : 10 mΩ max. at 1A 2VDC
- Insulation resistance : 1.000 MΩ min. at 500VDC
- Dielectric strength : 2.000 Vrms 50 Hz min. between terminals
- Electrical life : 10.000 cycles min.
- Mechanical life : 2 position models : 100.000 cycles min.  
3 position models : 30.000 cycles min.

#### ENVIRONMENTAL SPECIFICATIONS

- Degree of protection : IP65
- Shock resistance : 100 g according to IEC 512-4, test 6c
- Vibration resistance : 10-500 Hz - 10 g according to IEC 512-4, test 6d
- Salt spray resistance : 96 hours according to IEC 512-6, test 11f
- Operating temperature : 2 position models : -40°C to + 85°C  
3 position models : -10°C to + 65°C

#### MATRIX MOUNTING

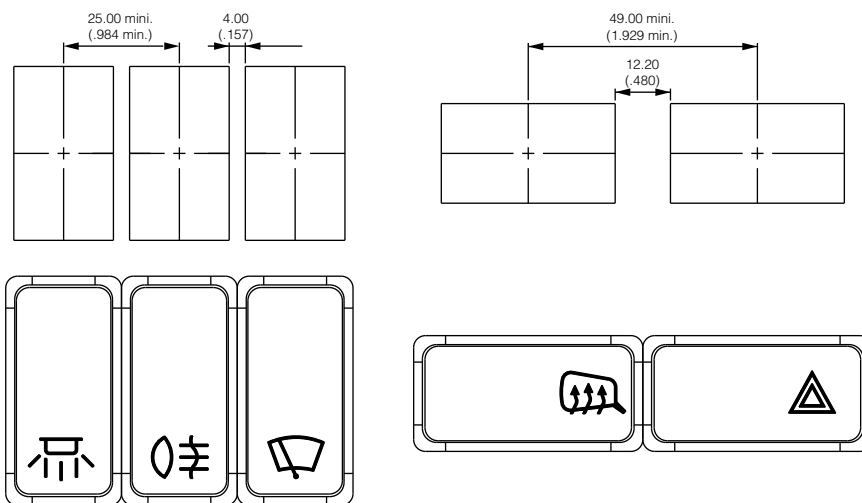

#### MATERIALS

- Case : thermoplastic UL94-V0
- Terminals : brass, silver plated
- Contacts : silver grain
- Contact roller : brass, nickel plated

#### AGENCY APPROVAL



EN 61058-1

**Availability** : double pole models, functions ON-OFF and ON-ON.

**Marking** : to order switches marked VDE, add "VDE" at the end of model number.

**Dimensions** : First dimensions are in mm while inches are shown as bracketed numbers.

**Tolerance** : The general tolerance for dimensions in this brochure is  $\pm 0,3$  (.012). Overall dimension tolerance is  $\pm 0,5$  (.020).



**Packaging unit** : 40 pieces

Dimensions, specifications and data shown in this brochure are subject to change without notice.



www.ermec.com

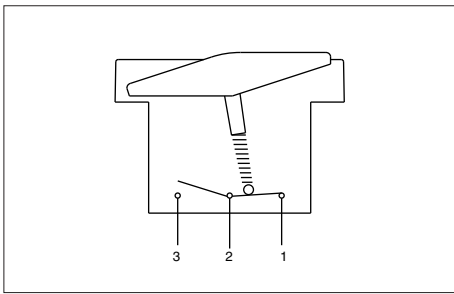

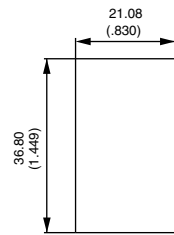

#### PANEL CUT-OUT

Panel thickness :  
0,8 mm to 4,6 mm  
Recommended thickness :  
between 2 mm and 3,5 mm

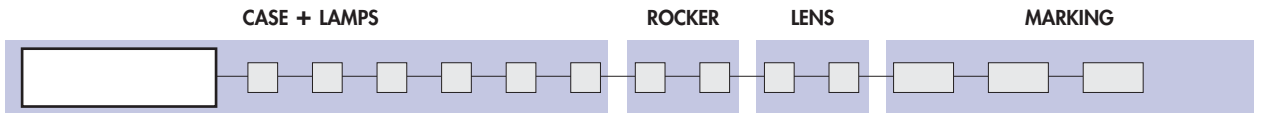

#### MODEL STRUCTURE





		2-3	1-2	
		5-6	4-5	
Single pole	Double pole			
<b>KG31</b>	<b>KG41</b>	ON - OFF		
	<b>KG44*</b>	ON ON ON		
	<b>KG44-1R*</b>	ON ON MOM		
<b>KG35</b>	<b>KG45</b>	MOM - ON		
<b>KG36</b>	<b>KG46</b>	ON - ON		
<b>KG37</b>	<b>KG47</b>	MOM OFF MOM		
<b>KG38</b>	<b>KG48</b>	ON OFF MOM		
<b>KG39</b>	<b>KG49</b>	ON OFF ON		

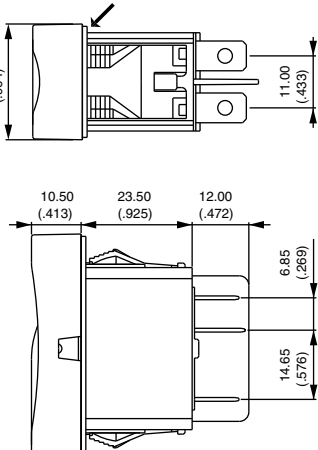

→ Flat seal

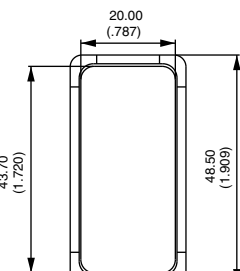

\* Function 4 : single pole in double pole case

#### TERMINALS

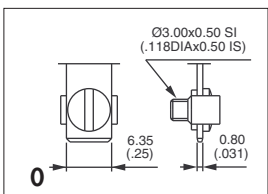
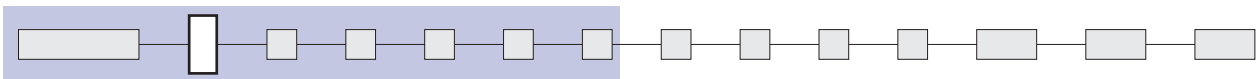

0 Screw

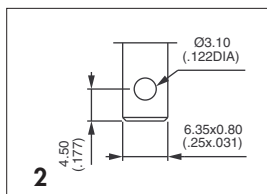

2 Solder lug / quick-connect

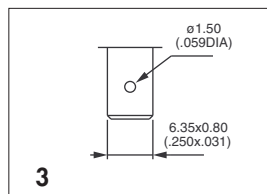

3 Quick-connect

Terminals 1 to 6 are marked on the case.

Side A : terminals 1 and 4  
Side B : terminals 3 and 6

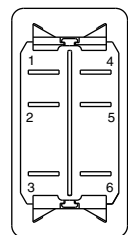

Side B

#### CONTACT MATERIALS

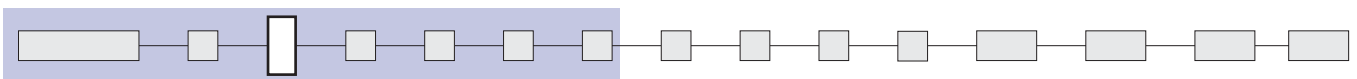

**A** Silver grain  
Functions ON-OFF and ON-ON : 15A 12VDC , 10A 24VDC, 15A 250VAC max. - 10mA 14 VDC min.  
Other functions : 10A 12VDC, 8A 24VDC, 10A 250VAC max.



## Power rocker switches

### Lamps

#### BEZEL

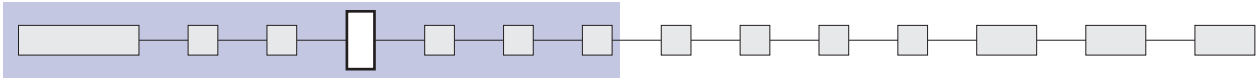

2 Black, sealed to IP65

#### LAMPS

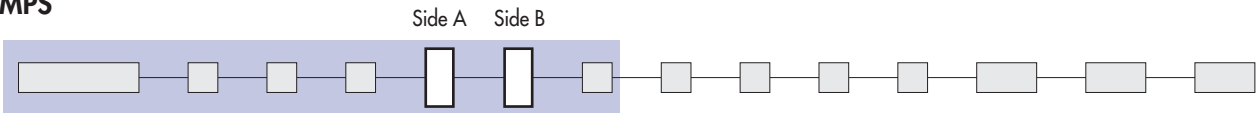

Complete each enlarged box with one of the codes listed below.

X	Without lamp
A	6V LED red
B	6V LED green
C	6V LED yellow
D	12V LED red
E	12V LED green
F	12V LED yellow
G	18V LED red
H	18V LED green
I	18V LED yellow

J	24V LED red
K	24V LED green
L	24V LED yellow
M	Neon 125V
N	Neon 250V
O	Filament 6V
P	Filament 12V
R	Filament 24V
S	Fluorescent 220V
T	Fluorescent 110V

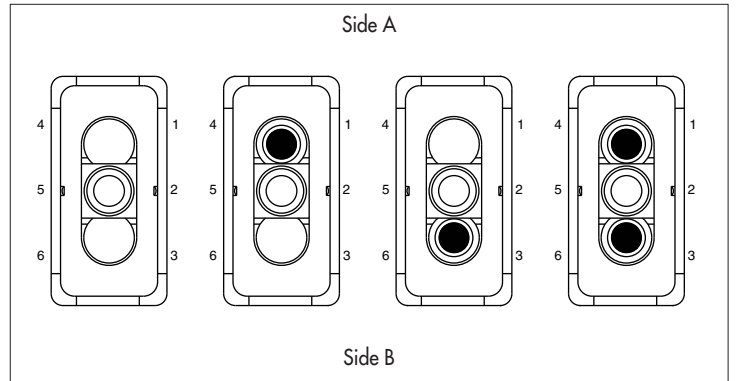

#### LAMP WIRING

The lamp wiring diagram is shown on the case.

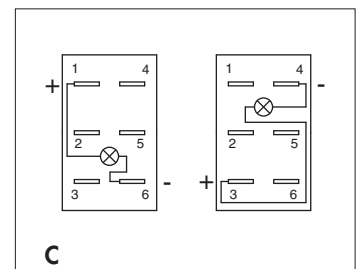
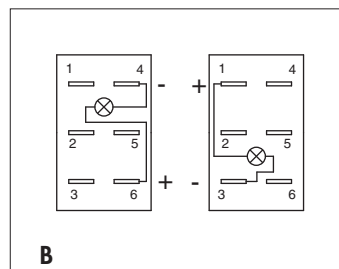
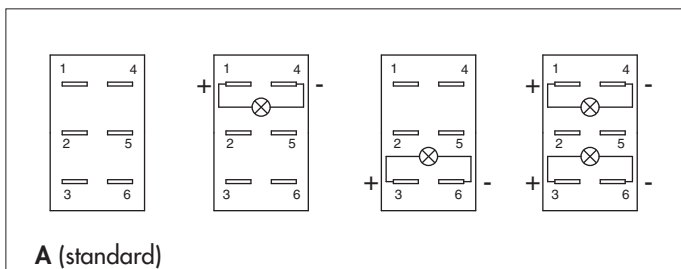
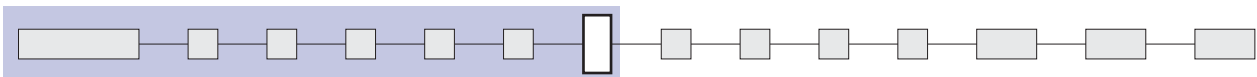

Note : If not available, terminals are added to connect the LED.

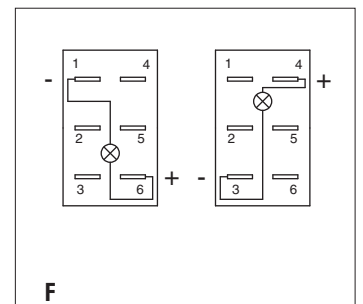
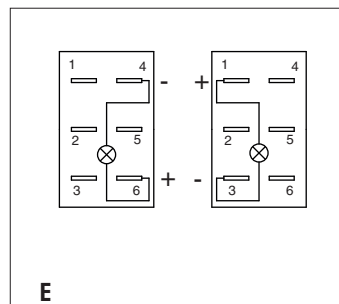
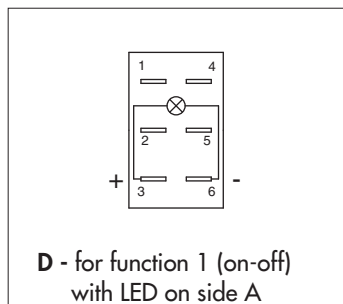

To order case only (without rocker), finish your order number with the lamp wiring code.



#### ROCKER COLOUR

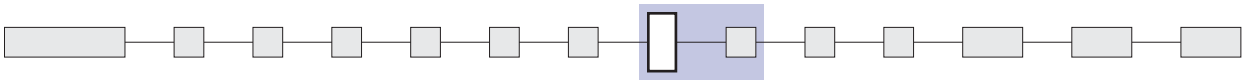

1	Blue
1/4	Dark blue
2	Black
3	Green
4	Grey

5	Yellow
6	Red
7	Ivory
9	Orange

#### ROCKER SHAPE

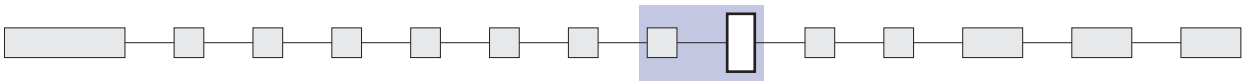

1

Full rocker



4

Opening on side A



6

Opening on side B



8

Opening on sides A and B

Other rocker shapes on customer specifications : on request.

**To order rocker only (without case), begin the order number with code KGR, then follow the order format from "rocker colour" until the end of the options.**

#### LENS COLOUR

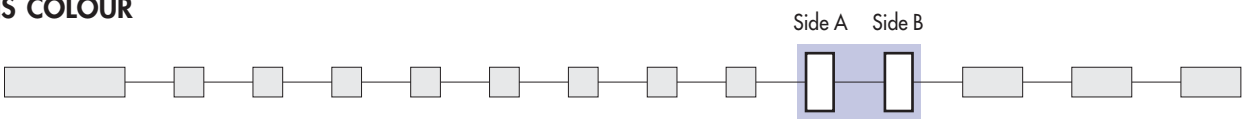

Complete each enlarged box with one of the codes listed below.

X	No lens
1	Blue *
3	Green *
6	Red
9	Orange
B	White
T	Translucent

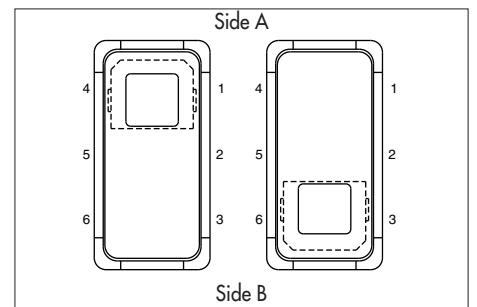

\* Blue or green lens recommended with fluorescent lamp.

**To order lenses only, begin the order number with the codes :  
KGLA for lens A and KGLB for lens B,  
then follow the order format from "lens colour" until the end of the options.**



## Power rocker switches

### Marking

#### MARKING

If no marking required, leave all boxes blank.

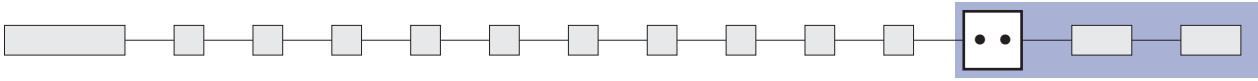

Select one option from each of the tables below.

MARKING METHOD	
C	Hot stamping

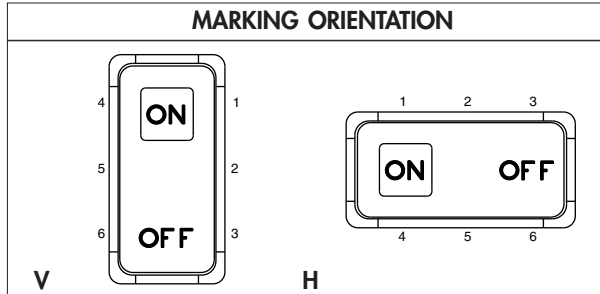

Other orientations :  
on request

#### SYMBOLS

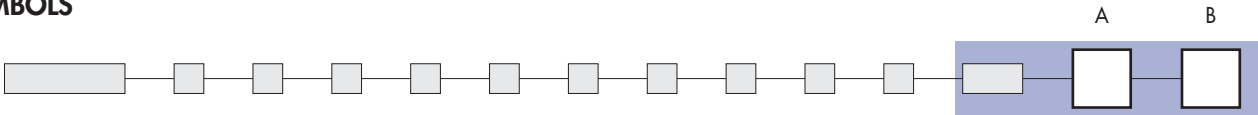

Available symbols : see page 31.

#### Marking colour

White marking for black rockers - Black marking for colour rockers  
Other : on request.

#### Marking area

For illuminated versions. The symbol will be included in the hatched area.

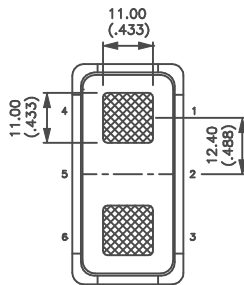
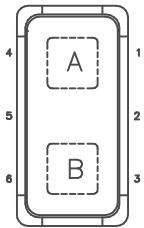

































Most symbols meet the ISO 7000 standard “graphical symbols for use on equipments” (code given in bracket in the description). Contact us for symbols not featured in the following tables.

**Legend scale :**

KR series : 1:1

KL, KG and KI series : depending on space available on the product (see “Symbols” section at the end of each series).

CODE	SYMBOL	DESCRIPTION	CODE	SYMBOL	DESCRIPTION	CODE	SYMBOL	DESCRIPTION
XX	None	-	16		Revolving light	32		Emergency first aid vehicle (2565)
01	<b>ON</b>	-	17		Rear ventilator	33		Load tipping (1557)
02	<b>OFF</b>	-	18		Heating (0637)	34		Loading light (2457)
03		-	19		Door opening	35		Tractor, rear-ward (0089)
04	<b>I</b>	-	20		Windshield demister/defroster (0635)	36		Combine, direction of movement (1678)
05	<b>II</b>	-	21		Windshield wiper (0086)	37		Use no forks (2406)
06	<b>STOP</b>	-	22		Windshield washer (0088)	38		Transmission (1166)
07	<b>A</b>	Stop	23		Ventilator fan (0089)	39		Working spot light (1145)
08	<b>M</b>	Motion	24		Side mirror defroster	40		Engine (0634)
09		Up motion	25		Restarting pump	41		Horn (0244)
10		Down motion	26		Front fog lights (0633)	42		Lock (1656)
11		Hot	27		Rear fog lights (0634)	43		Taxi sign light (2551)
12		Cold	28		Propulsion system trim	44		Working light (1024)
13		Hazard warning (0085)	29		Beacon (1141)	45		Working light symmetric (1024)
14		Traveller lighting	30		Anchor	46		-
15		Driver lighting (1421)	31		Electric motor (0011)	47		-

## Power rocker switches and indicators

### Symbols

Most symbols meet the ISO 7000 standard "graphical symbols for use on equipments" (code given in bracket in the description). Contact us for symbols not featured in the following tables.

**Legend scale :**

KR series : 1:1

KL, KG and KI series : depending on space available on the product (see "Symbols" section at the end of each series).

CODE	SYMBOL	DESCRIPTION	CODE	SYMBOL	DESCRIPTION	CODE	SYMBOL	DESCRIPTION
48		All wheel drive	64		Indicator	80		Front windshield heating
49		Differential lock (1662)	65		Brake release	81	AUS	Aus
50		-	66		Baggage room left door	82		Radiator fan
51		-	67		Baggage room right door	83		Remove retarder
52		-	68		Power blinds	84		Restricted speed
53	N	-	69		Engine idle control	85		Preheater
54		Rear window wiper (0097)	70	CRUISE RES/SET	Cruise res/set	86		ABS detection
55		Rear window washer (0099)	71		Driver windows up/down	87		ECAS detection
56		Lower load (2223)	72		Middle door opening	88		Engine stop
57		Cab lock (1560)	73		Front door opening	89	CRUISE RES/CAN	Cruise res/cancel
58		Extraction	74		Lighting in baggage room	90		ECAS reset
59		Pumping in	75	CRUISE ON/OFF	Cruise on/off	91		Driver windows heating
60		Rear PTO (1572)	76	TV	TV	92	CRUISE SET+/SET-	Cruise set
61		Front PTO	77		Pump	93		Air bag up/down
62		Rockshaft down	78	WC	Toilet	94		Read lighting
63		Rockshaft up	79		Toilet decontamination	95		Lighting main switch

Most symbols meet the ISO 7000 standard “graphical symbols for use on equipments” (code given in bracket in the description). Contact us for symbols not featured in the following tables.

**Legend scale :**

KR series : 1:1

KL, KG and KI series : depending on space available on the product (see “Symbols” section at the end of each series).

CODE	SYMBOL	DESCRIPTION	CODE	SYMBOL	DESCRIPTION	CODE	SYMBOL	DESCRIPTION
96		Heating using water	AD		-	AV		-
97		Low beam	AE		-	AW		-
98		Position lights	AF		-	AY		-
99		Diesel acceleration	AG		Battery charging condition (0247)	AZ		-
A1		Manual mode	AH		Turn signals (0084)	B1	HIGH	-
A2		Clockwise cabin rotation	AJ		High beam (0082)	B2	LOW	-
A3		Anticlockwise cabin rotation	AK		Differential lock, bogie (2600)	B3		-
A4		-	AL		Brushing with a rotating brush (0070)			
A5		-	AM		Differential lock, transfer case 4x4 (2475)			
A6		Parking brake	AN		Loader bucket, float (1441)			
A7		-	AP		Loader bucket (1437)			
A8		-	AQ		Rear window washer & wiper (0098)			
A9		-	AR		Header Header drive (1579)			
AA		-	AS		Excavator/backhoe boom side shift (2091)			
AB		-	AT		Chemical water treatment (1851)			
AC		-	AU		Grapple skidder, single funct° boom (1762)			



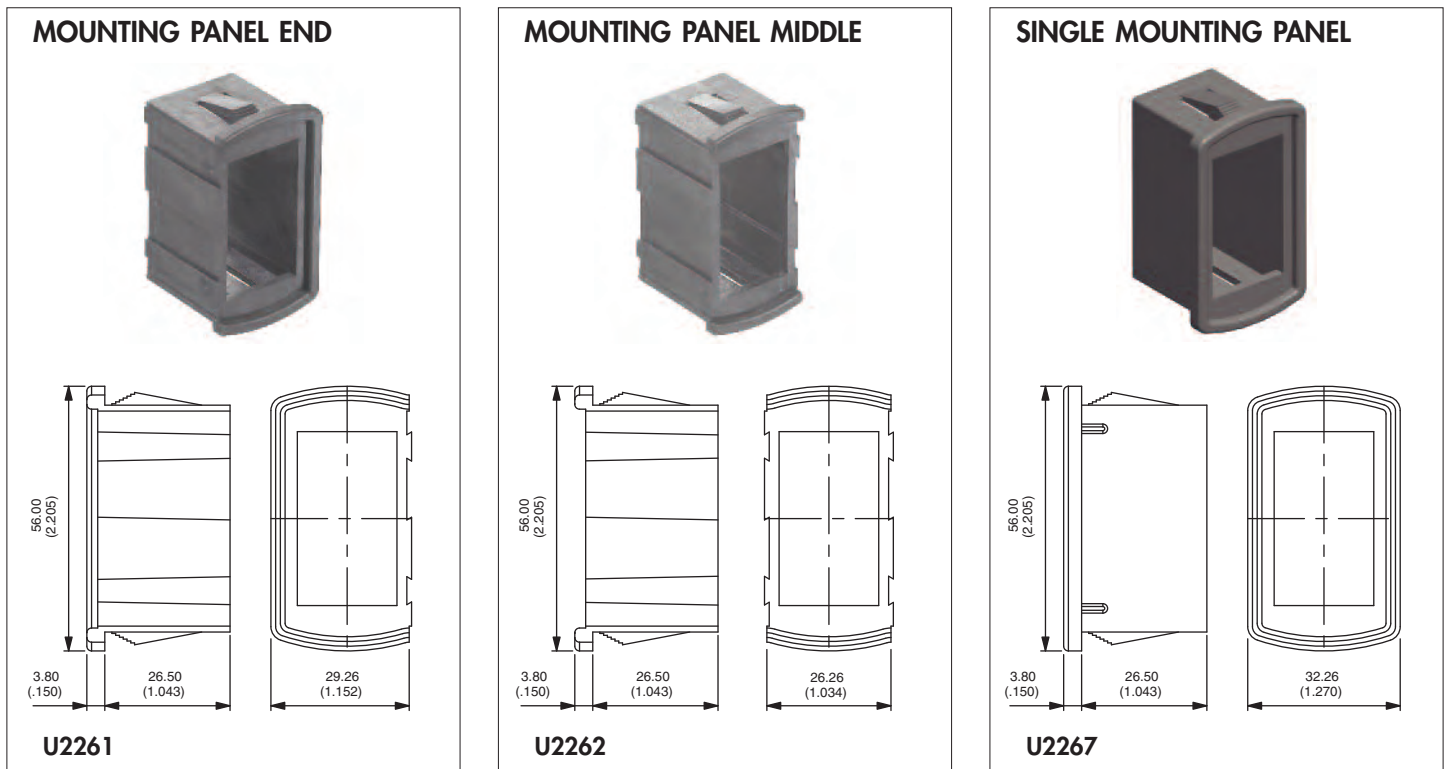

Recommended panel thickness : 1,10 mm - 1,80 mm - 2,60 mm - 3,40 mm - 4,20 mm - 5 mm - 5,80 mm

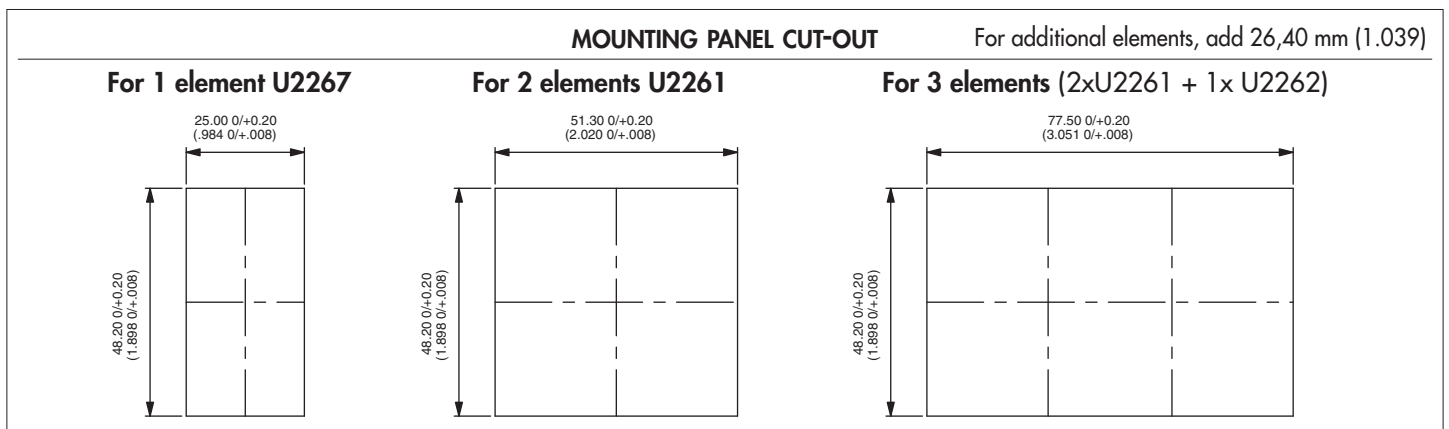

### ACTUATOR REMOVING TOOL



2 tools are supplied

#### EXTRACT ACTUATOR (KR ONLY)

Allows the extraction of the rocker / rocker support assembly.  
Place the 2 claws under the support and push as indicated by the arrow.

#### EXTRACT ROCKER (KR ONLY)

Allows to separate the rocker from its support.

Insert the tool between rocker and support as indicated by the arrow. Pull out the tool in the opposite direction.

#### EXTRACT SWITCH (KR, KL AND KI)

Allows to extract switch from panel mounting units. 2 tools are necessary.

Insert the tools between switch and panel mounting units from the rear to compress the snap-in device. Pull off switch manually.

### CONNECTORS

Standard colour : black. Other colours : on request.  
Connectors cannot be combined with wiring types H and I.

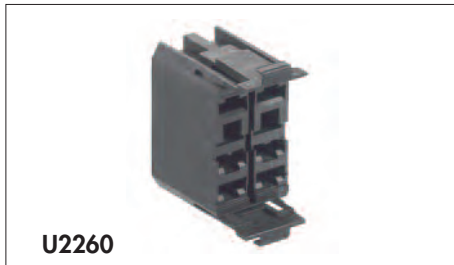

**U2260**

#### 6 terminal version

For use with terminals type 2, 3, 4 or 5.  
6,35 (1/4) tabs to be fitted by the user  
(example : AMP/Tyco 0-0141013-2).  
Can be used for the KG series.



**U2282**

#### 10 terminal version

For use with terminals type H or J.  
2,8 (.110) tabs to be fitted by the user  
(example : AMP/Tyco 0-927779-3).

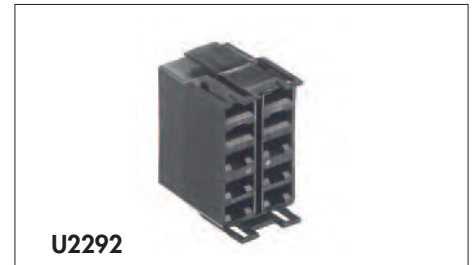

**U2292**

#### 10 terminal version

For use with terminals type B, C, E or F.  
6,35 (1/4) tabs to be fitted by the user  
(example : AMP/Tyco 0-0141013-2).

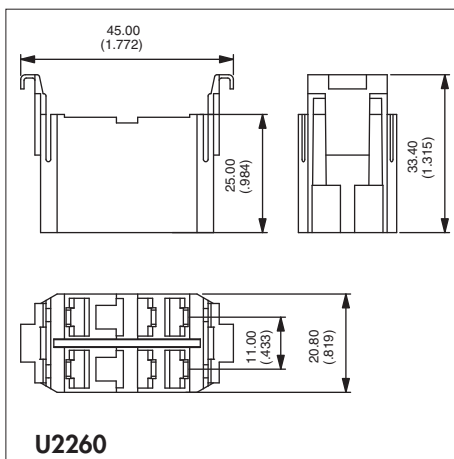

**U2260**

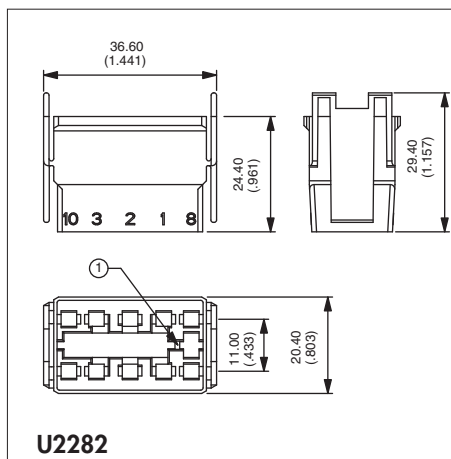

**U2282**

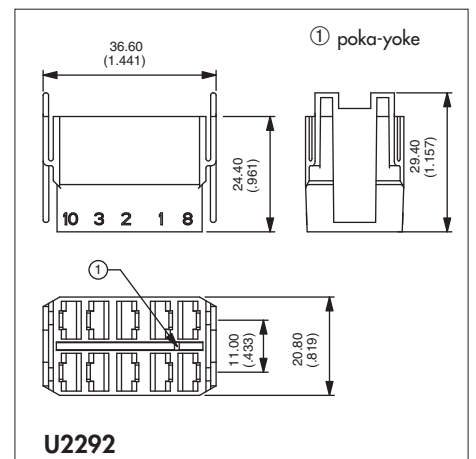

**U2292**

### HOLE PLUGS

Usefull for future extensions.

Code	Colour	Code	Colour
<b>U2271</b>	Blue	<b>U2274</b>	Grey
<b>U2271/4</b>	Dark blue	<b>U2275</b>	Yellow
<b>U2272</b>	Black	<b>U2276</b>	Red
<b>U2273</b>	Green	<b>U2277</b>	Ivory
		<b>U2279</b>	Orange

Recommended panel thickness :  
1,50 mm to 6 mm

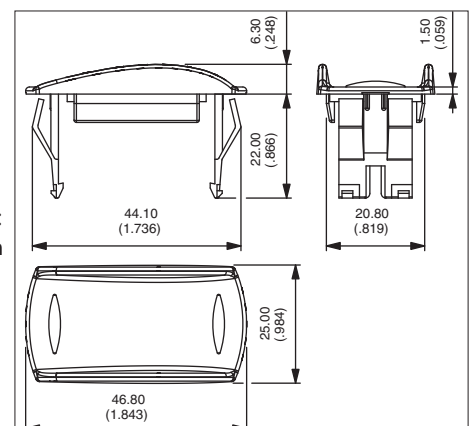

Connectors can be hanged on specific hole plugs. Contact APEM.

# APEM, a world of switching capabilities

ermec@ermec.com

The APEM group is one of the world's largest manufacturers of switches, switch panels and joysticks.

APEM designs, develops, manufactures and sells electro-mechanical components to multiple industrial markets including: instrumentation, medical, security, communications, industrial automation, avionics, military and transport.

## Other APEM embedded products



### ■ " I " range of pushbuttons

This range consists of several series of IP67 sealed pushbuttons (IP, IB, IS, IF, IA) and a large variety of models: round or square, momentary or latching, illuminated or non-illuminated, plastic or metallic, with optional marking.



### ■ Specific switch panels

In addition to the switching function, specific switch panels incorporate several other functions such as illumination by LED, backlighting, EMC protection, sealing, connection, support, mounting...

Applications for these products include transport and utility vehicles, agricultural engines and boats.



### ■ Joysticks

APEM also manufactures joysticks for professional applications. Easy to operate, reliable and designed for extremely long service life, APEM joysticks are offered with a wide range of options allowing to satisfy a large variety of requirements. Several series are available, each one based on a different technology: switch joysticks, potentiometer joysticks and contactless joysticks.



A P E M

Addresses of sales subsidiaries and distributors network on  
[www.apem.com](http://www.apem.com)

ERMEC

[www.ermec.com](http://www.ermec.com)

K0806-A