

## DIN Rail Mount Enclosure IDG-A

**IDG-A1: Snap-together design with installed width of 17.5<sup>-0.5</sup> mm**

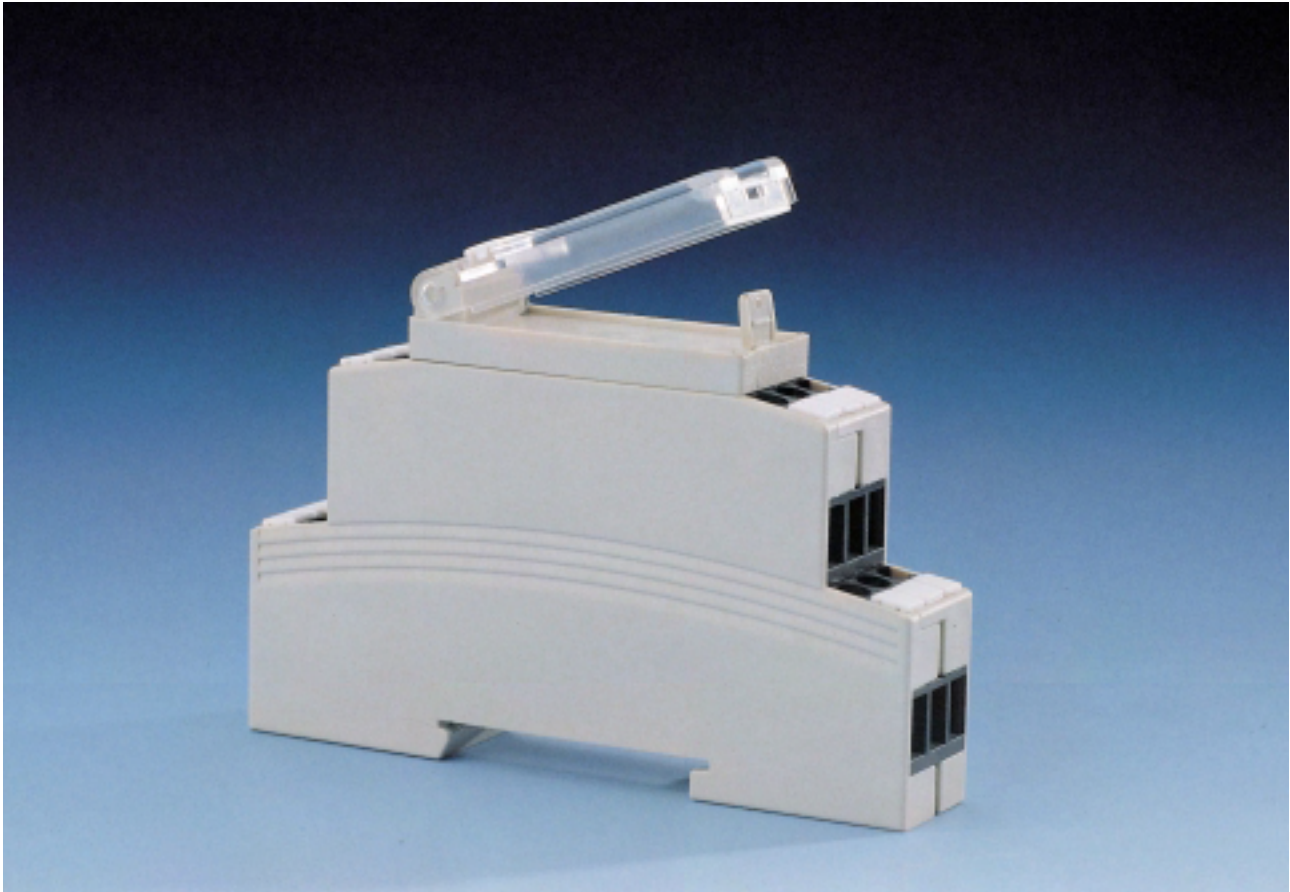

### General

The new IDG-A1 DIN rail mount enclosure is ideal for applications requiring a housing for smaller pcbs and minimal DIN rail space loss. The IDG-A1 has sleek lines, making this an attractive packaging medium for applications such as home/building automation.

This enclosure has been designed according to DIN 43 880, providing the dimensions and specifications required for installation component standards. Conforming to VBG 4 and IEC529/DIN VDE 0470-1, the IDG-A1 prevents accidental shock and injury while meeting the requirements of the automation industries. This new housing enables users to incorporate one vertical pcb and a top horizontal pcb or three horizontal pcbs. The top horizontal pcb is ideal for holding signalling devices/indicators and switches. Fully populated, the terminal blocks have a maximum of 12 screw clamp terminals. For applications not requiring all 12 I/O positions or requirements for additional internal space, selective loading may be done, with empty positions being filled with blind plugs.

### Main Features

- Installed width of 17.5<sup>-0.5</sup> mm
- Dimensional size per DIN 43 880, component size 1
- Mountable to DIN rails meeting DIN 46 277 and DIN EN 50 022 (35mm)
- Ease of assembly due to snap-together design
- One main PCB (vertical) or up to three horizontal PCBs
- Two terminal blocks (one left, one right), each with two sets of three positions (may be custom-loaded)
- Blind insert may be utilized in-place of terminal blocks for maximum space utilization
- 2 cover versions: grey cover or grey cover frame for clear hinged face plate (for access to switching components)
- Grounding connection via DIN rail pending
- Customer-specific colors and designs available upon request

### Electrical and Mechanical Characteristics

Type	IDG-A1
Degree of Protection	IP 20
Air Distance and Creepage per VDE 0110 for Terminal Block	min. 2.5 mm
Creepage proof acc. to IEC 112 for Terminal Block	CTI 250
Insulation Material acc. to VDE 0110	III a
Maximum Current	max. 12 A
Maximum Wire Size	max. 2.5 mm <sup>2</sup> (14 AWG)
Materials	
Upper Housing Shell	PC 30 % GF UL 94-V1
Lower Housing Shell	PC 30 % GF UL 94-V1
Blind Terminal Block	PC 30 % GF UL 94-V1
Cover	PC 30 % GF UL 94-V1
Hinged Face Plate	PC UL 94-V2
Terminal Block	PA 46 30 % GF UL 94-V0
Blind Plug	PC UL 94-V2
Screw Clamp	Steel (zinc plated)
pcb Termination Pin	CuSn 6 (2 µm Ni +5 µm SnPb plating)
Nomenclature Marker	PA 66
Operating Temperature	-40 °C .... +110 °C (-40 °F ... +230 °F)
Outer Dimensions: With Cover (W x H x D)	90 x 58 x 17.7 mm (3.54 x 2.28 x 0.70 inches)
Outer Dimensions: With Hinged Face Plate (W x H x D)	90 x 60 x 17.7 mm (3.54 x 2.36 x 0.70 inches)

All data only for the housing shell without pcb connection. because of the wiring.  
 Notice the influencing of the air distance and the creepage

### IDG-A1: Dimensional Drawing

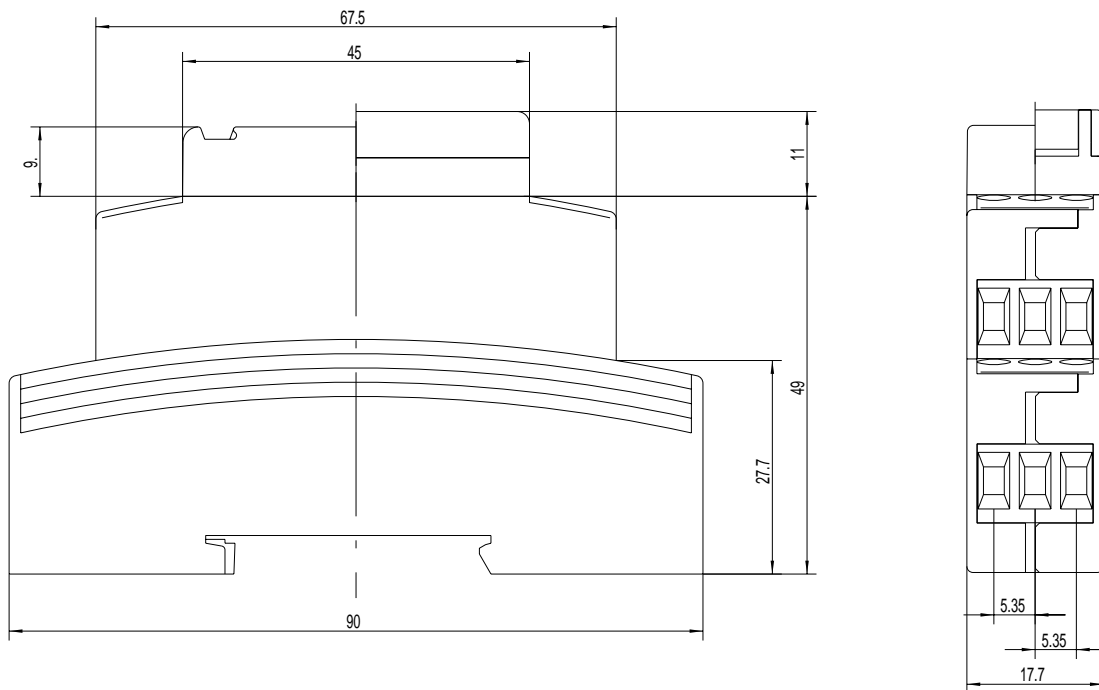

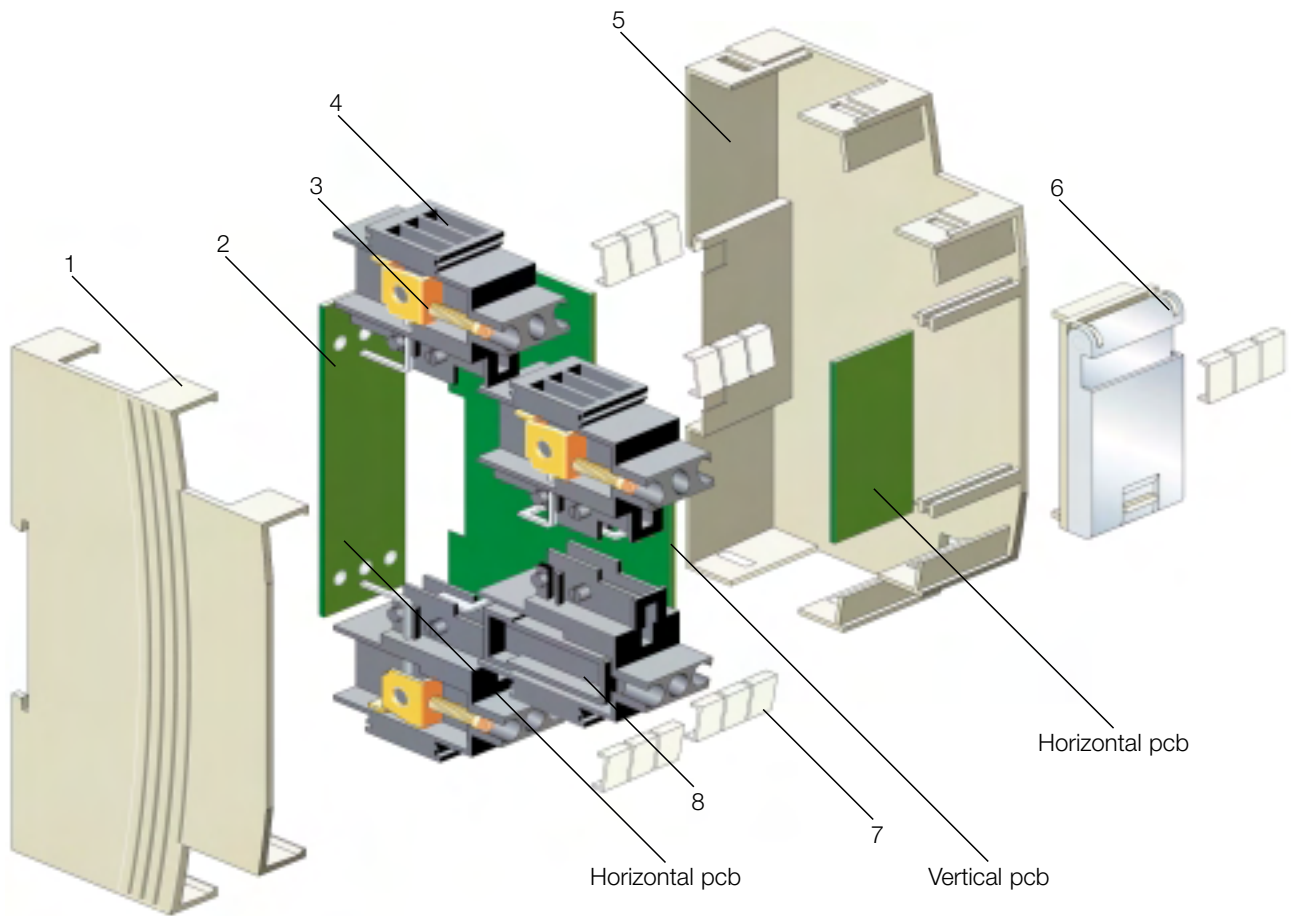

**Individual Components**

Item	Description	Material
1	Upper Housing Shell	PC 30% GF
2	pcb Termination Pin	CuSn6 (tin plated)
3	Screw Clamp	Steel (zinc plated)
4	Terminal Block	PA 46 30% GF
5	Lower Housing Shell	PC 30% GF
6	Cover with Hinged Face Plate	PC 30% GF/PC
7	Snap-on Nomenclature Marker	PA 66
8	Blind Plug	PC



## Ordering Information

Part	PCB Orientation*	Cover Version	Part No.
Complete Kit	Vertical	Cover	<b>104990</b>
Complete Kit	Vertical	Cover with Hinged Face Plate	<b>104991</b>
Complete Kit	Horizontal	Cover	<b>104992</b>
Complete Kit	Horizontal	Cover with Hinged Face Plate	<b>104993</b>

Note: \*pcb Orientation is in relation to DIN rail  
 The complete kits are packaged individually and consist of the following: an upper housing shell, lower housing shell,

two left terminal blocks, two right terminal blocks (both terminal blocks are populated with 6 pins and screw clamps each) and a cover.

The individual components listed in the table below are ideal for applications with high production volumes.

For complete kits, please refer to the table at the top of the page.

Part	Part No.
Lower Housing Shell	<b>064080</b>
Upper Housing Shell	<b>064081</b>
Left Terminal Block, Assembled	<b>104872</b>
Right Terminal Block, Assembled	<b>104873</b>
Horizontal pcb Terminal Block, Assembled	<b>104874</b>
Snap-on Nomenclature Markers	<b>104413</b>
Blind Terminal Block	<b>064085</b>
Empty Terminal Block Housing	<b>064086</b>
Blind Plug for Terminal Block Housing	<b>414466</b>
Screw Clamp	<b>104150</b>

Part	Part No.
pcb Pin 1, Left/Right	<b>064087</b>
pcb Pin 2, Left	<b>064088</b>
pcb Pin 3, Left	<b>103681</b>
pcb Pin 2, Right	<b>103950</b>
pcb Pin 3, Right	<b>103951</b>
pcb Pin Horizontal pcb	<b>103684</b>
Cover	<b>064082</b>
Cover Frame for Hinged Face Plate	<b>064083</b>
Hinged Face Plate, Transparent	<b>064084</b>

## Installation Diagram

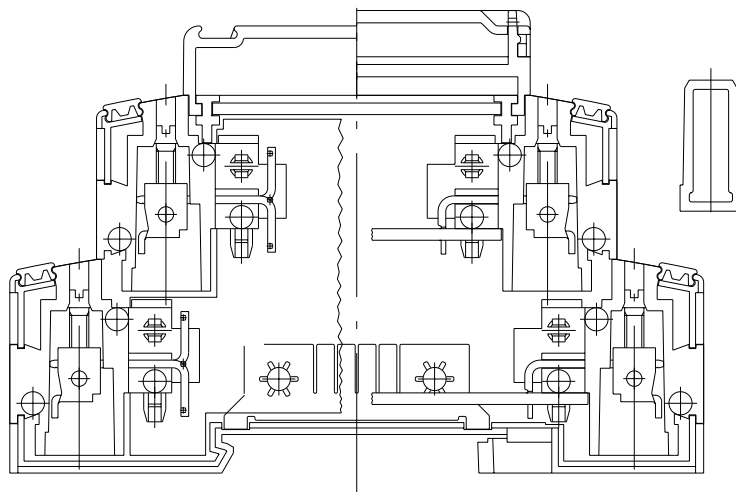

# Miniature Enclosures LDG-A

## The base for all applications Complete family for measuring-/ control technique

Fully-insulated enclosure conforming to the standards of the machine construction and automotive industry with safe-to-touch terminals per VDE 0100 and VBG 4. Facility of inserting max. 2 vertical pcbs as well as 1 horizontal pcb as connection between the 2 vertical pcbs and location for

display and control elements. Housing base optionally with or w/o ventilation slots. Housing surface erosion-textured in attractive design. Easy assembly and disassembly for service purposes.

### Technical Data

Description	LDG-A-12	LDG-A-14	LDG-A-16	LDG-A30	LDG-A-46	LDG-A-70
Protection	Housing IP40					
	Terminal IP20					
Housing base	Polycarbonate (30% GV), RAL 7032, UL 94 V-1					
Terminal housing, cover and blind plugs	Polycarbonate, UL 94 V-2					
Striking distance / track resistance	≥3mm / CTI 275		≥4mm / CTI 275			
creepage / track resistance	≥3,2mm / CTI 275		≥5mm / CTI 275			
Material	sheet steel, tinned					
Terminals	Wire cross section		max. 2,5 mm <sup>2</sup>		max. 4mm <sup>2</sup>	
	Rate current		max. 16A		max. 20A	
Terminal pins	Tin bronze 2µm initial Ni plating 5µm tin plating		2µm Ni		brass  5µm Sn	
Temperature range	-40° C ... +110° C					
Overall dimensions L x W x H	75 x 22.5 x 98.5 mm 75 x 22.5 x 110 mm	75 x 45 x 110 mm	75 x 55 x 110 mm	75 x 99.7 x 110 mm	75 x 150 x 110 mm	75 x 225 x 110 mm

### Just snap them on

LDG enclosures have a snap-on fixing for standard rails per DIN 46277 and DIN EN 50022.

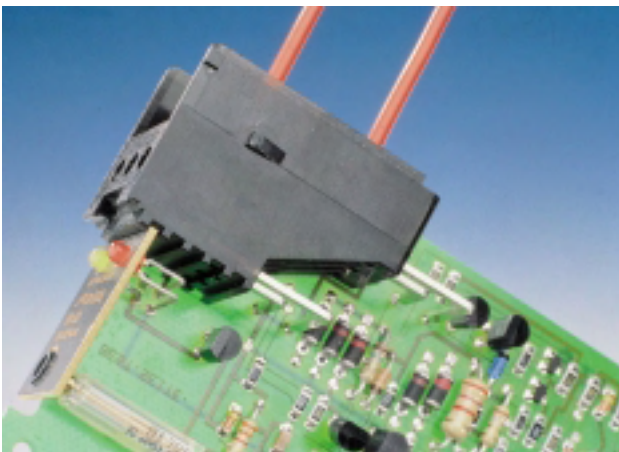

### Rationalized connection technique

Easy connection from the connection cable via the terminal housing to the pcb.

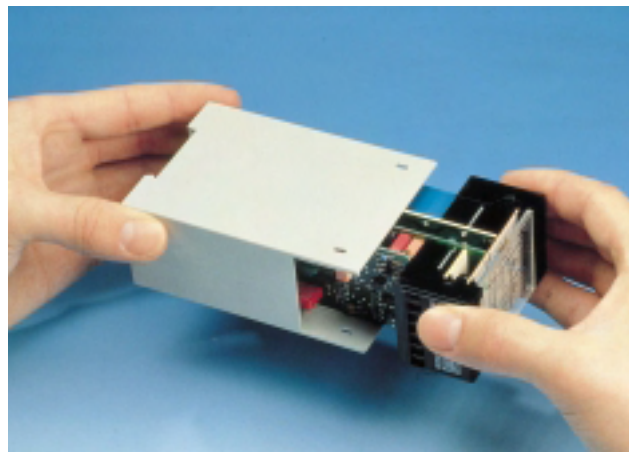

### Fast component-mounting and manufacturing

The pcb assembled with components and the terminal housing is being soldered completely in one working process.

## Further enclosures for secure packaging for your electronics

### DIN Rail Mount Enclosures IDG-B2 and IDG-B4

Width 35.0 mm (max. 10 clamps) and width 70.0 mm (max. 24 clamps)

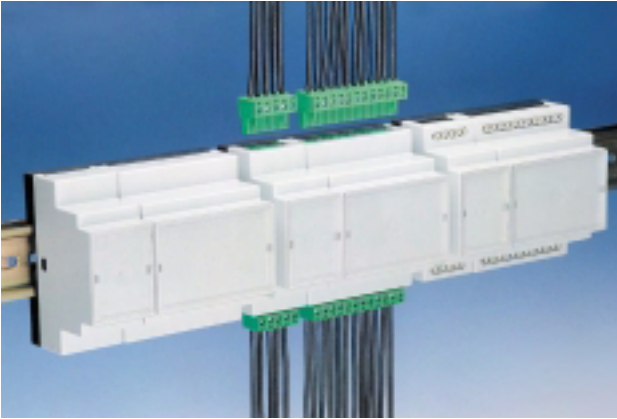

#### General

- 2 installation widths: IDG-B2: 35 mm, IDG-B4: 70 mm
- Dimensional size per DIN 43 880, component size 1
- Ease of assembly to DIN rails per DIN 46 277 and DIN EN 50 022
- Various termination options:
  - 5.0 / 5.08 mm terminal blocks
  - 5.0 / 5.08 mm pluggable terminal blocks
  - choice of connector on front cover
- 2 daughter boards each pluggable either vertically or horizontally; safe guidance in guiding slots.
- Transparent cover protects displays and control devices
- DIN rail clip pre-assembled on housing base
- Customer-specific colors and design on request.

### LDG-D series

Enclosure series available in 3 different dimensional sizes  
Wire termination via Faston connector or screw terminal



### LDG-M4

Waterproof housing for fluid technique  
Degree of protection IP 67





**Our Products:**

Two-Part connectors to DIN 41 612 / IEC 603-2 and VG 95 324  
Press-fit connectors  
SMT connectors  
Miniature connectors with 1.27 mm pitch, Series SMC  
ERmet, 2.0 mm interconnection system  
CompactPCI, Connectors and Backpanels  
Fibre optic cable connectors  
D-Sub Cable connector housings with EMI and ESD protection  
D-Sub Connectors, Series TMC  
ERbic, Bus Interface Connector  
ERNIPRESS systems including PC Boards to customer's specifications  
Complete interfacing system for all connectors  
Modular connector housing system for 6, 8, 14, 30, 64, and 96 pins  
LDG / IDG series of DIN rail mountable miniature enclosures  
Insulation displacement connectors for 10-96 pins  
Pin connectors, 1-100 pins

**ERNI Elektroapparate GmbH**

D-73099 Adelberg, Postfach  
Telephone +49 (0)7166 50-0, Fax +49 (0)7166 50 282  
E-Mail: info@erni.de

**ERNI Components, Inc.**

12701 North Kingston Avenue, Chester, VA 23836 USA  
Telefon +1 804 530-5012, Fax +1 804 530-5232

**ERNI Elektrotechnik AG**

CH-8306 Brüttisellen, Stationsstraße 31  
Telefon +41 (0)1 835 33 83, Fax +41 (0)1 833 07 30

**ERNI connectique S.a.r.l.**

F-69258 LYON Cedex 09, 27 bis, avenue des Sources / CP 638  
Telefon +33 (0)4 72 17 80 81, Fax +33 (0)4 78 66 19 89

**ERNI Australia Pty Ltd**

12 Monomeeth Drive, Mitcham, 3132 VIC,  
Telefon +61 3 98748566, Fax +61 3 98743160

**ERNI Asia Pte Ltd**

Singapore 199466, 50A Bussorah Street  
Telefon +65 295 2113, Fax +65 297 7203

**Internet: <http://www.erni.com>**

**We are also represented in following countries:**

Austria, Belgium, Brazil, China, Czech Republik, Denmark, Finland, Great Britain, Hong Kong, India, Indonesia, Israel, Italy, Japan, Korea, Malaysia, Netherlands, Norway, Poland, Portugal, Sweden, Slovenia, Spain, South Africa, Taiwan, Thailand, Turkey