



Enclosures LDG-A

ERMEC, S.L. BARCELONA
 C/ Francesc Teixidó, 22
 E-08918 Badalona
 (Spain)



Tel.: (+34) 902 450 160
 Fax: (+34) 902 433 088
info@ermec.com
www.ermec.com

ERMEC, S.L. MADRID
 C/ Sagasta, 8, 1ª planta
 E-28004 Madrid
 (Spain)

PORTUGAL
portugal@ermec.com
 BILBAO
bilbao@ermec.com



ERMEC, S.L. BARCELONA
C/ Francesc Teixidó, 22
E-08918 Badalona
(Spain)



Tel.: (+34) 902 450 160
Fax: (+34) 902 433 088
info@ermec.com
www.ermec.com

ERMEC, S.L. MADRID
C/ Sagasta, 8, 1ª planta
E-28004 Madrid
(Spain)

PORTUGAL
portugal@ermec.com
BILBAO
bilbao@ermec.com

www.erni.com

Enclosures LDG-A

Table of Contents



General information about LDG-A enclosures	.2
Technical Data	.3
Temperature Range	.3
The base for economical and compact packaging of your electronics	.4
Terminal block design and type overview	.5
Pluggable terminals and blind inserts	.6
Flexibility for customized solutions	.7
Enclosure versions with ventilation slots	.8
Enclosure LDG-A 12	.9
Enclosure LDG-A 14	.12
Enclosure LDG-A 16	.14
Enclosure LDG-A 30	.16
Enclosure LDG-A 46	.18
Enclosure LDG-A 70	.20

ERMEC, S.L. BARCELONA
C/ Francesc Teixidó, 22
E-08918 Badalona
(Spain)



Tel.: (+34) 902 450 160
Fax: (+34) 902 433 088
info@ermec.com
www.ermec.com

ERMEC, S.L. MADRID
C/ Sagasta, 8, 1ª planta
E-28004 Madrid
(Spain)

PORTUGAL
portugal@ermec.com
BILBAO
bilbao@ermec.com



Types

- LDG-A-12, max. 12 screw clamp terminals
- LDG-A-14, max. 14 screw clamp terminals
- LDG-A-16, max. 16 screw clamp terminals
- LDG-A-30, max. 30 screw clamp terminals
- LDG-A-46, max. 46 screw clamp terminals
- LDG-A-70, max. 70 screw clamp terminals

General

The LDG-A series of enclosures are fully insulated enclosures. The screw clamp terminals are protected against accidental contact in accordance with VDE 0100 Part 570, VDE 0160 Part 100 and VBG 4. Designed for easy installation, these screw terminals can be soldered by wave, allowing the manufacturing of the PCB boards in one step.

Features

- Snap-in design for fast end assembly
- Complete assembly of the unit outside of the housing before end assembly
- Robust self locking vibration proof terminal block screws
- Protection against accidental human contact
- Transparent cover for LED indicators
- Suitable frame inserts for pluggable standard connectors
- Base parts with and without ventilation slots
- Base part metallized
- Compact and attractive design
- Wall and DIN rail mountable

Type	LDG-A-12	LDG-A-14	LDG-A-16	LDG-A-30	LDG-A-46	LDG-A-70
Degree of protection	IP20					
Air distances	≥ 3 mm		≥ 4 mm			
Creepage distances	≥ 3.2 mm		≥ 5 mm			
Voltage rating (IEC 60664)	The permissible operating voltages depend on the customer application and on the applicable or specified safety requirements. Insulation coordination according to IEC 60664-1 has to be regarded for the complete electrical device. Therefore, the maximum creepage and clearance distances of the mated connectors are specified for consideration as a part of the whole current path. In practice, reductions in creepage or clearance distances may occur due to the conductive pattern of the printed board or the wiring used, and have to be taken into account separately. As a result the creepage and clearance distances for the application may be reduced compared to those of the connector.					
Screw clamp	steel, tin plated					
Terminal wire size	max. 2.5 mm ²		max. 4 mm ²			
	current rating		max. 16 A			
tightening torque	max. 16 A		max. 20 A			
	max. 0.4 Nm					
material	CuSn6		Ms			
Terminal pin plating	2 μm Ni		2 μm Ni			
	5 μm Sn		5 μm Sn			
Temperature range	-40° C ... +110° C					
Base part	PC (30% GF), RAL 7032, UL 94 V-0					
Terminal block housing, cover and blind plug	PC UL 94 V-0					
Outside dimensions L x B x H	75 x 22.5 x 98.5 mm	75 x 45 x 110 mm	75 x 55 x 110 mm	75 x 99.7 x 110 mm	75 x 150 x 110 mm	75 x 225 x 110 mm
	75 x 22.5 x 110 mm					
Aprovales UL	File E 84703					
CSA	File LR 62504					

Temperature Range

Enclosure Typ LDG-A-	Inside temperature 95°								
	Ambient temperature								
	23°C			50°C			70°C		
	A	A	C	A	B	C	A	B	C
12	8	6	3	5	4	2	2,5	2	1
14	12	10	7	7	6	4	4	3	2
16	13	11	9	8	7	5	4	3,5	3
30	19	18	16	12	11	10	7	6	5
46	26	23	20	16	14	12	9	8	7
70	36	33	30	23	21	19	12	10	11
Dissipation in W									

A = Both side faces not obstructed, free airflow

B = One side face blocked by obstruction, 0 mm away

C = Both side face blocked by obstruction, 0 mm away

ERMEC, S.L. BARCELONA
C/ Francesc Teixidó, 22
E-08918 Badalona
(Spain)



Tel.: (+34) 902 450 160
Fax: (+34) 902 433 088
info@ermec.com
www.ermec.com

ERMEC, S.L. MADRID
C/ Sagasta, 8, 1ª planta
E-28004 Madrid
(Spain)

PORTUGAL
portugal@ermec.com
BILBAO
bilbao@ermec.com

Enclosures LDG-A

The base for all applications

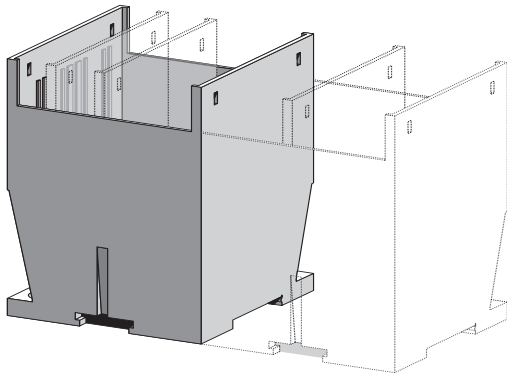

Fully-insulated enclosures in accordance with machinery and automotive industry standards, with shockproof terminals acc. to VDE 0100 and VBG 4.
Base part optionally with or without ventilation slots.
Enclosure surface with erosion-structure in attractive design.
Easy assembly and disassembly for servicing.

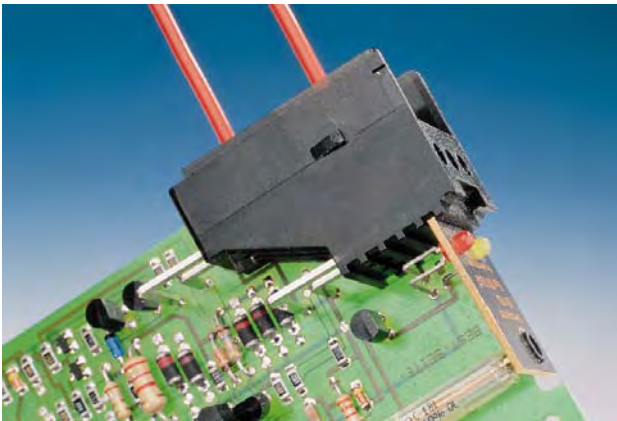

Easy connecting technique

From the connection cable via the terminal block to the PC board, the connection could not be more simple.



Generously dimensioned stacking compartment

Printed circuit boards can be stacked one above the other such that complex assemblies can be implemented in compact dimensions.

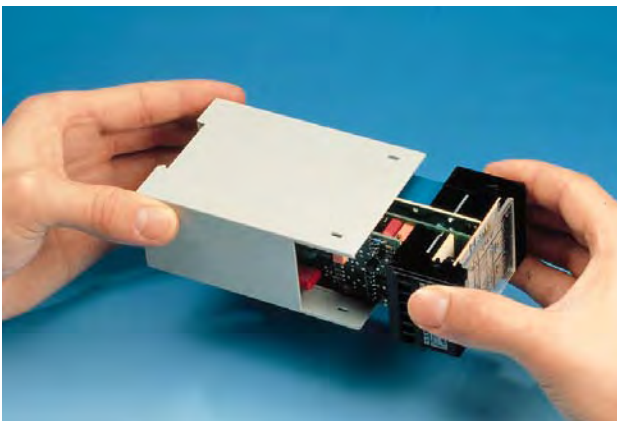

Fast component-mounting and manufacturing times

The PC board, with the mounted components and terminal blocks will be wave-soldered, in one work process and then completely assembled into the base part in one step.



Just snap them on

LDG-A enclosures have a snap-on clip for easy snap-on assembly for standard DIN rails acc. to DIN 46277 and DIN EN 50022.

ERMEC, S.L. BARCELONA Tel.: (+34) 902 450 160
C/ Francesc Teixidó, 22 Fax: (+34) 902 433 088
E-08918 Badalona info@ermec.com
(Spain) www.ermec.com
 Distribución de componentes eléctricos y electrónicos

ERMEC, S.L. MADRID **PORTUGAL**
C/ Sagasta, 8, 1ª planta portugal@ermec.com
E-28004 Madrid **BILBAO**
(Spain) bilbao@ermec.com

Enclosures LDG-A

Terminal block design and type overview

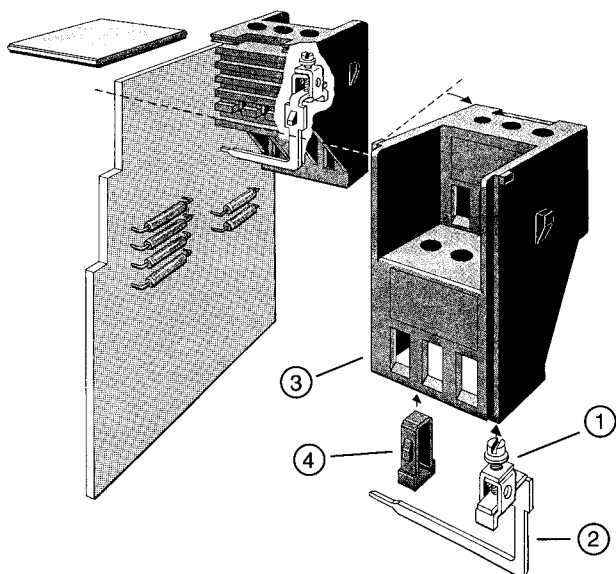

- 1 Terminal clamp
- 2 Terminal pin
- 3 Terminal block housing
- 4 Blind plug

LDG-A 14, 16, 30, 46, 70

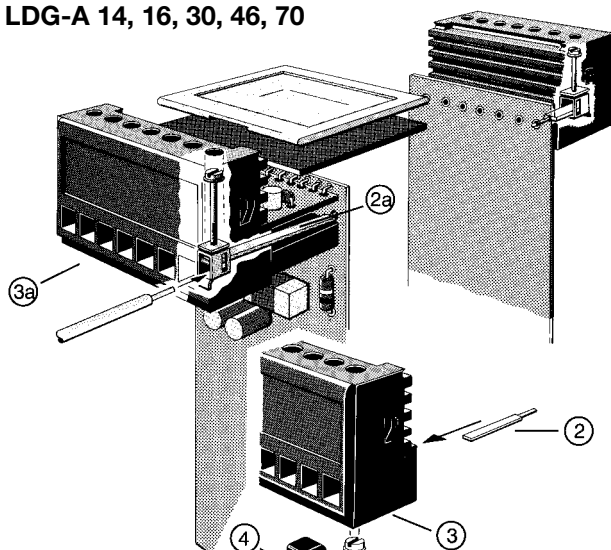

- 1 Terminal clamp
- 2 Terminal pin, short
- 2a Terminal pin, long
- 3 Terminal block housing, narrow
- 3a Terminal block housing, wide
- 4 Blind plug



LDG-A 12

Length: 75 mm
Width: 22.5 mm
Height: 98.5 mm
or 110 mm



LDG-A 14

Length: 75 mm
Width: 45 mm
Height: 110 mm



LDG-A 16

Length: 75 mm
Width: 55 mm
Height: 110 mm



LDG-A 30

Length: 75 mm
Width: 99.7 mm
Height: 110 mm

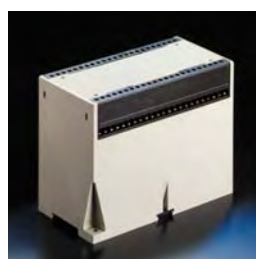

LDG-A 46

Length: 75 mm
Width: 150 mm
Height: 110 mm

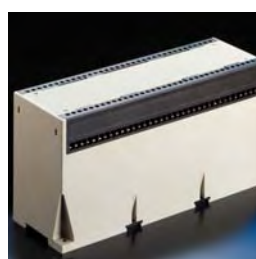

LDG-A 70

Length: 75 mm
Width: 225 mm
Height: 110 mm



Easy service and device exchange

Frame inserts with cut-out for commercially available pluggable terminal connectors

Features:

- Used as assembly and guide element for the PC board with guides for transverse board and longitudinal board offset by 90°.
- Compact design for secure snap-on and safe fixing on the base part.
- Screw-on option for the cover.

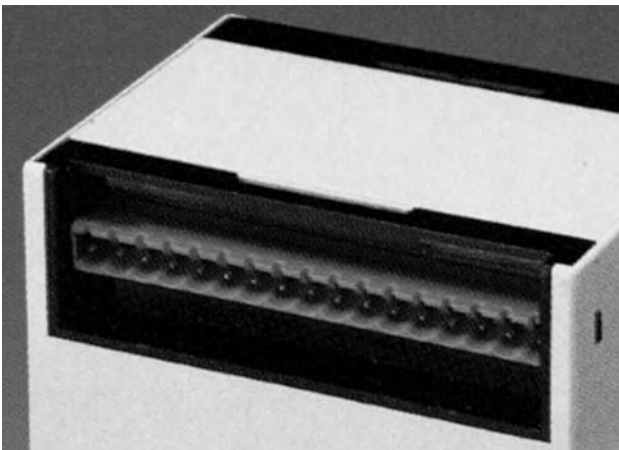
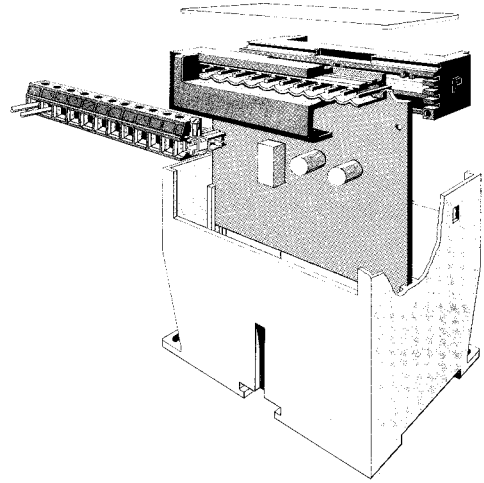

Frame insert with top cutout for separate pin header. For maximum component space on the longitudinal board.

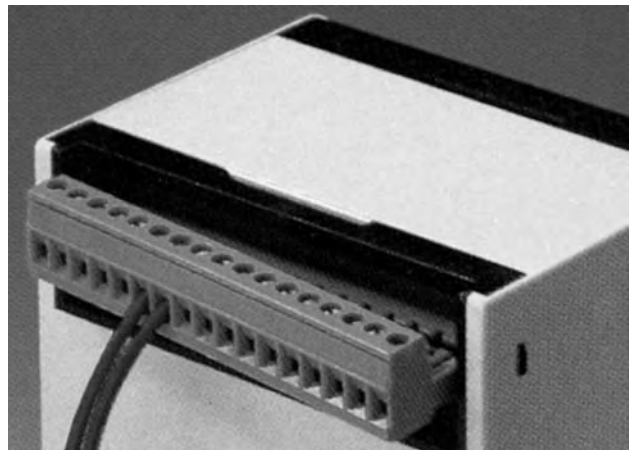

Connection of commercially available screw-plug connectors.

Ordering information

Description	Color	Part no.
LDG-A-16 Frame insert with top cutout	black	053869
Frame insert with bottom cutout	black	053870
Blind insert	black	053871
LDG-A-30 Frame insert with top cutout	black	034769
Frame insert with bottom cutout	black	053164
Blind insert	black	053074
LDG-A-46 Frame insert with bottom insert	black	054248
Blind plug	black	054249
LDG-A-70 Blind insert	black	054730

Frame insert with top cutout for separate pin header. You will have the maximum component space on the PC board.

Frame insert with bottom cutout allows the assembly of a transverse board.

The **blind insert** provides for the full covering of the base part. Individual customized cutouts achieved by mechanical machining or special tool inserts are easy to be realized.

Technical data

Material of plastic parts: PC
 UL 94 V-0
 Color: black
 special colors upon request
 Temperature range: -40°C up to +110°C



Enclosures LDG-A

Flexibility for customized solutions



Various colors, e. g. company color for base part, cover or terminal block possible

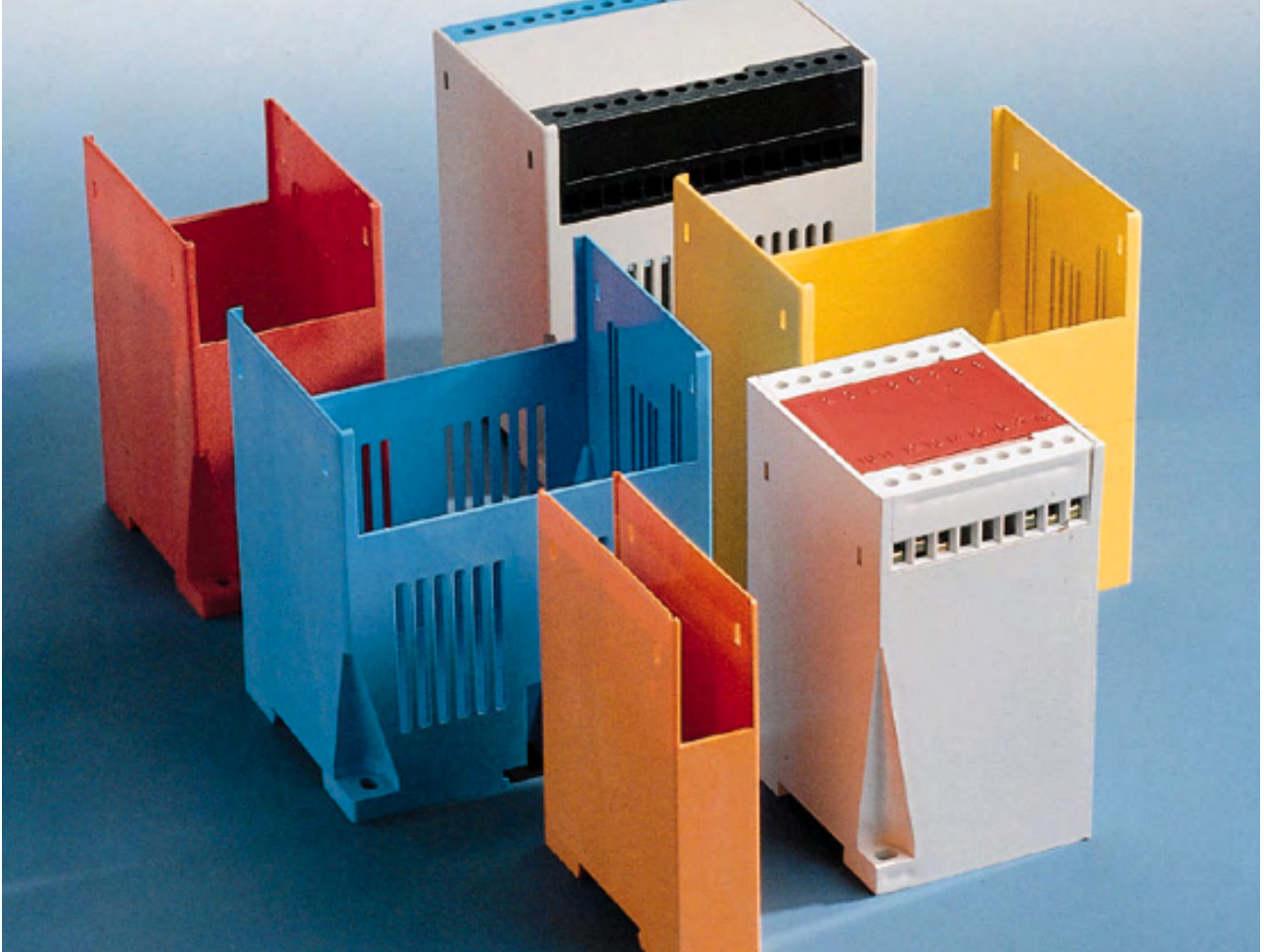

Cover in grey, black or transparent for display functions

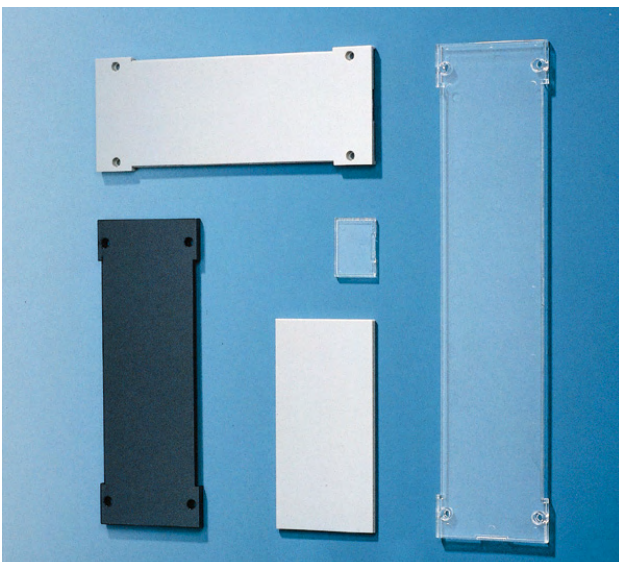

Customized cutouts and holes in covers and blind inserts

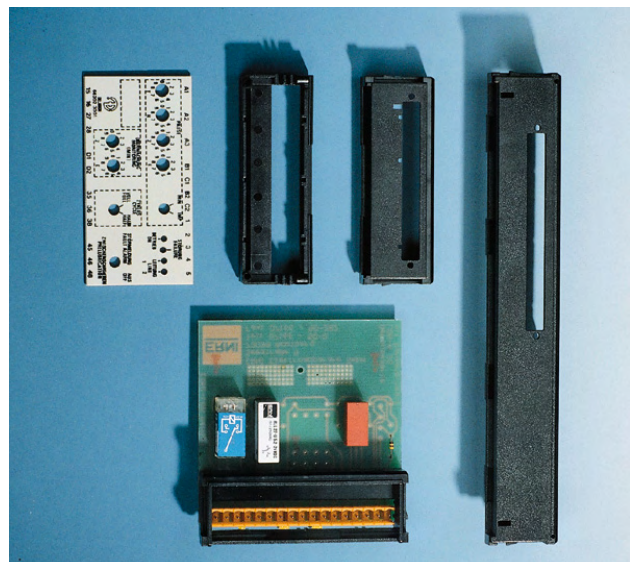

Enclosures LDG-A

Versions with ventilation slots



Effective heat dissipation for electronic subassemblies with increased heating



Base part with ventilation slots

- available for enclosure versions LDG-A-12, LDG-A-16, LDG-A-30, LDG-A-46, LDG-A-70
- slot dimension: 42 x 3 mm
- additional data upon request

Ordering information

Description	Color	Part no.
Base part with ventilation slots		
LDG-A-12	light grey	114932
LDG-A-16	light grey	024870
LDG-A-30	light grey	434098
LDG-A-46	light grey	024080
LDG-A-70	light grey	424328

ERMEC, S.L. BARCELONA
C/ Francesc Teixidó, 22
E-08918 Badalona (Spain)

Tel.: (+34) 902 450 160
Fax: (+34) 902 433 088
info@ermec.com
www.ermec.com



Distribución de componentes eléctricos y electrónicos

ERMEC, S.L. MADRID
C/ Sagasta, 8, 1ª planta
E-28004 Madrid (Spain)

PORTUGAL
portugal@ermec.com
BILBAO
bilbao@ermec.com

Enclosures LDG-A

LDG-A 12



- For max. 12 screw clamp terminals, 6 on each side
- Partial loaded terminal blocks with blind plugs
- PCB board arrangement see drawing

Length: 75 mm
 Width: 22.5 mm
 Height: 98.5 mm or 110 mm

Ordering information

Description	Type	Color	Part Number
Base part 110 mm	w/o ventilation slot	light grey	024082
Base part 110 mm	with ventilation slot	light grey	114932
Base part 98,5 mm	w/o ventilation slot	light grey	414470
Cover		transparent	414462
Cover		light grey	414463
Terminal block housing	right	black	414453
Terminal block housing	left	black	414455
Terminal pin	right, long		224082
Terminal pin	right, medium		224079
Terminal pin	right, short		224078
Terminal pin	left, long		224081
Terminal pin	left, medium		224077
Terminal pin	left, short		224080
Clamp, not assembled			414469
Terminal block, fully loaded	right	black	043853
Terminal block, fully loaded	left	black	043860
Blind plug		black	414466

ERMEC, S.L. BARCELONA Tel.: (+34) 902 450 160
 C/ Francesc Teixidó, 22 Fax: (+34) 902 433 088
 E-08918 Badalona **ERMEC** info@ermec.com
 (Spain) www.ermec.com **Distribución de componentes eléctricos y electrónicos** www.ermec.com

ERMEC, S.L. MADRID
 C/ Sagasta, 8, 1ª planta
 E-28004 Madrid
 (Spain)

PORTUGAL
portugal@ermec.com
BILBAO
bilbao@ermec.com

Dimensions: low height version

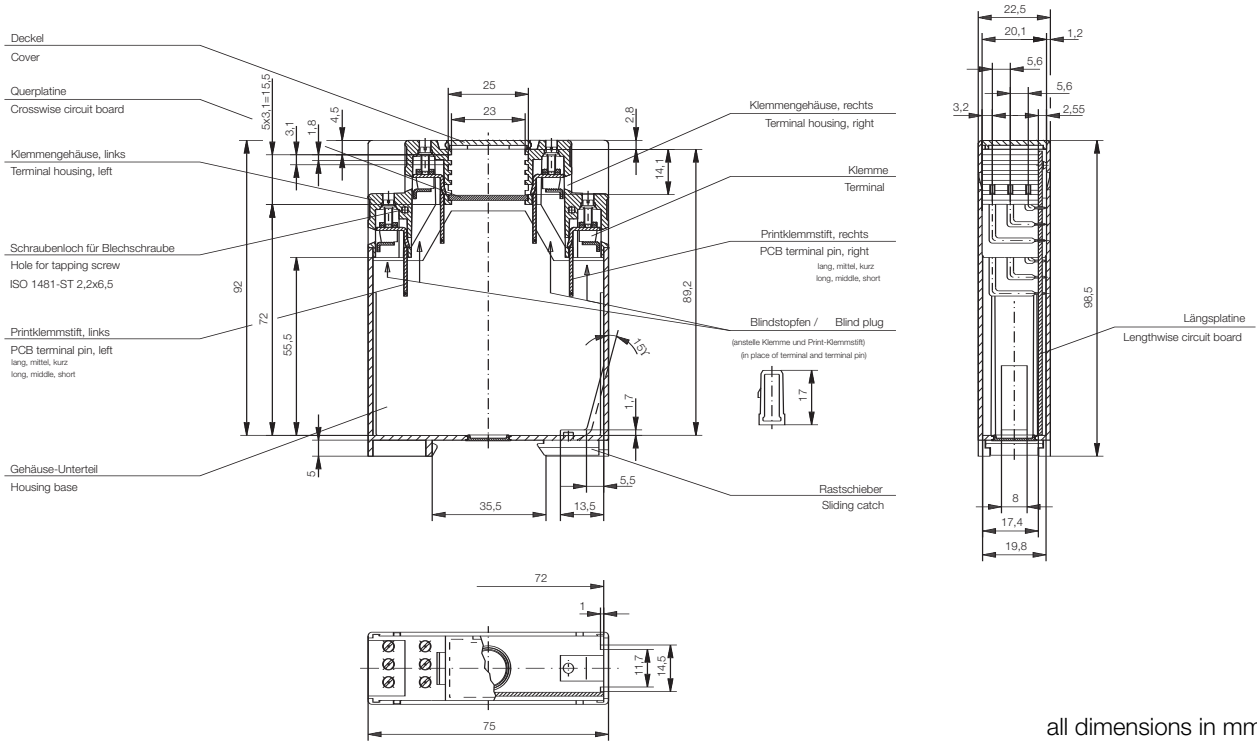

Recommended PCB dimensions

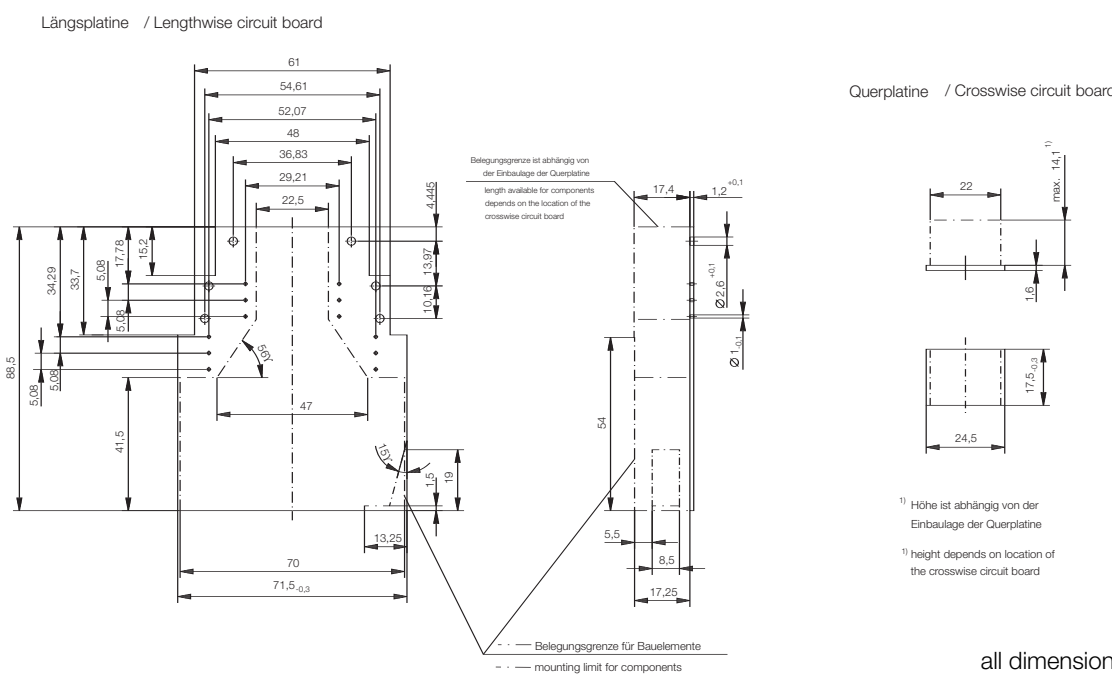

Enclosures LDG-A

LDG-A 14



- For max. 14 screw clamp terminals , 7 on each side
- Partial loaded terminal blocks with blind plugs
- PCB board arrangement see drawing

Length: 75 mm
 Width: 45 mm
 Height: 110 mm

Ordering information

Description	Type	Color	Part Number
Base part	w/o ventilation slots	light grey	423280
Cover		light grey	423273
Cover		transparent	423272
Cover		black	423274
Terminal block housing	narrow	black	423275
Terminal block housing	wide	black	423277
Terminal pin	short		224076
Terminal pin	long		224074
Clamp, not assembled			154562
Terminal block, fully loaded	narrow	black	914810
Terminal block, fully loaded	wide	black	914820
Blind plug		black	103006

ERMEC, S.L. BARCELONA Tel.: (+34) 902 450 160
 C/ Francesc Teixidó, 22 Fax: (+34) 902 433 088
 E-08918 Badalona  info@ermec.com
 (Spain) Distribución de componentes eléctricos y electrónicos www.ermec.com

ERMEC, S.L. MADRID
 C/ Sagasta, 8, 1ª planta
 E-28004 Madrid
 (Spain)

PORTUGAL
portugal@ermec.com
 BILBAO
bilbao@ermec.com

Dimensions

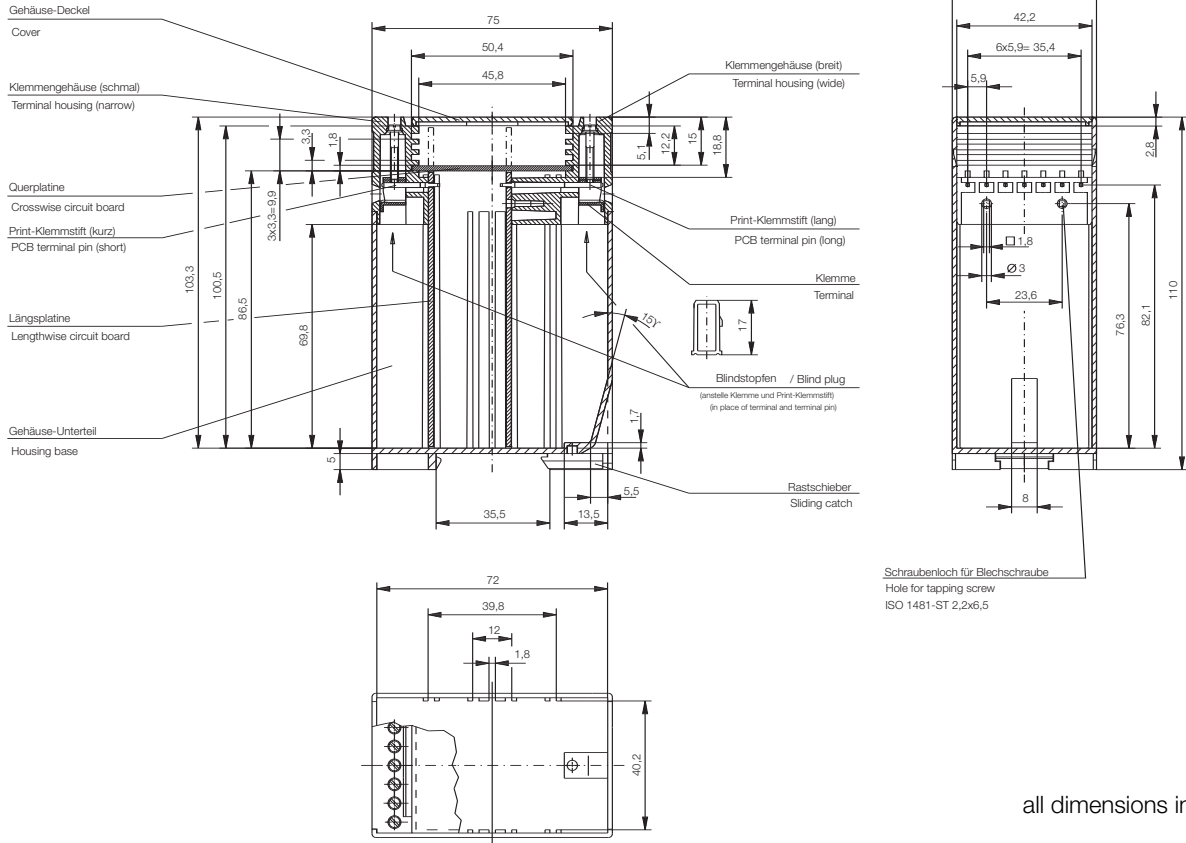

all dimensions in mm

Recommended PCB dimensions

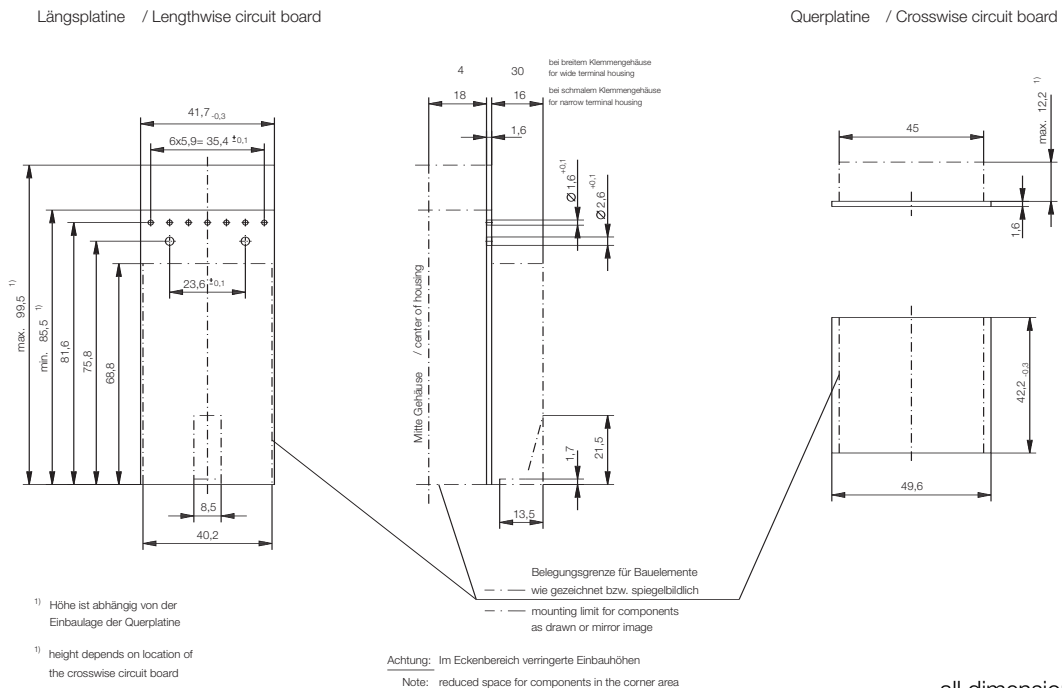

all dimensions in mm

Enclosures LDG-A

LDG-A 16



- For max. 16 screw clamp terminals, 8 on each side
- Partial loaded terminal blocks with blind plugs
- PCB board arrangement see drawing
- Special frames for pluggable standard connectors available

Length: 75 mm
 Width: 55 mm
 Height: 110 mm

Ordering information

Description	Type	Color	Part Number
Base part	w/o ventilation slots	light grey	414124
Base part	with ventilation slots	light grey	024870
Cover		light grey	014415
Cover		transparent	014416
Cover		black	014417
Terminal block housing	narrow	black	103031
Terminal block housing	narrow	blue	103033
Terminal block housing	wide	black	103032
Terminal block housing	wide	blue	103034
Terminal pin	short		224076
Terminal pin	long		224074
Clamp, not assembled			154562
Terminal block, fully loaded	narrow	black	914830
Terminal block, fully loaded	wide	black	914840
Blind plug		black	103006
Frame insert for pluggable connectors	Top cutout	black	053869
Frame insert for pluggable connectors	Bottom cutout	black	053870
Blind plug		black	053871

ERMEC, S.L. BARCELONA
 C/ Francesc Teixidó, 22
 E-08918 Badalona
 (Spain)



Tel.: (+34) 902 450 160
Fax: (+34) 902 433 088
info@ermec.com
www.ermec.com

ERMEC, S.L. MADRID
 C/ Sagasta, 8, 1ª planta
 E-28004 Madrid
 (Spain)

PORTUGAL
portugal@ermec.com
BILBAO
bilbao@ermec.com

Dimensions

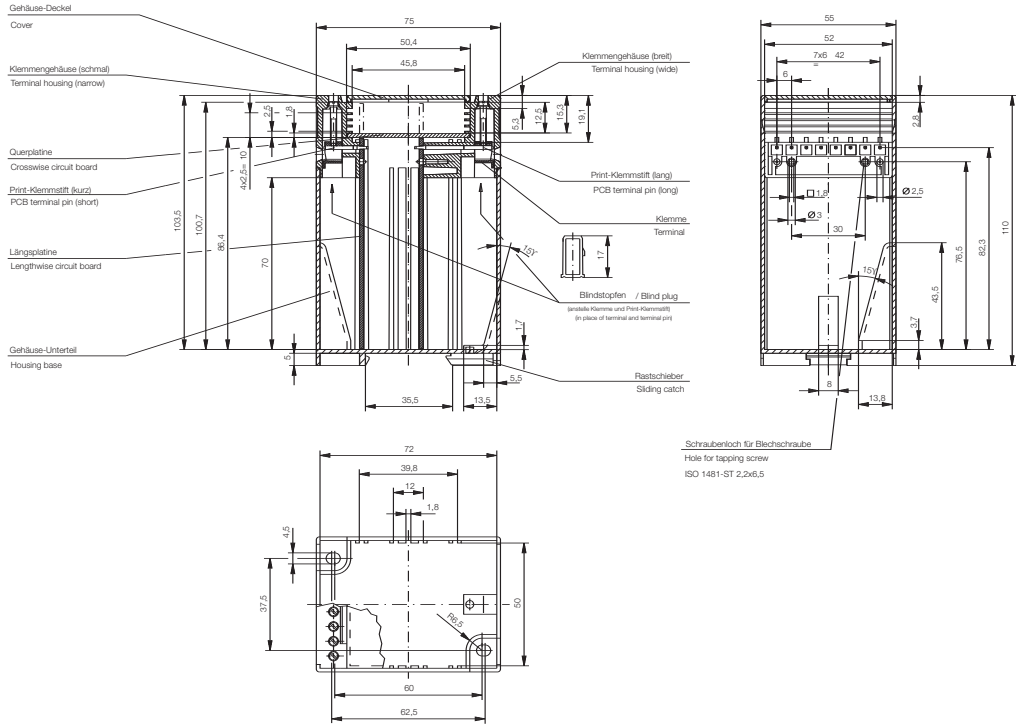

all dimensions in mm

Recommended PCB dimensions

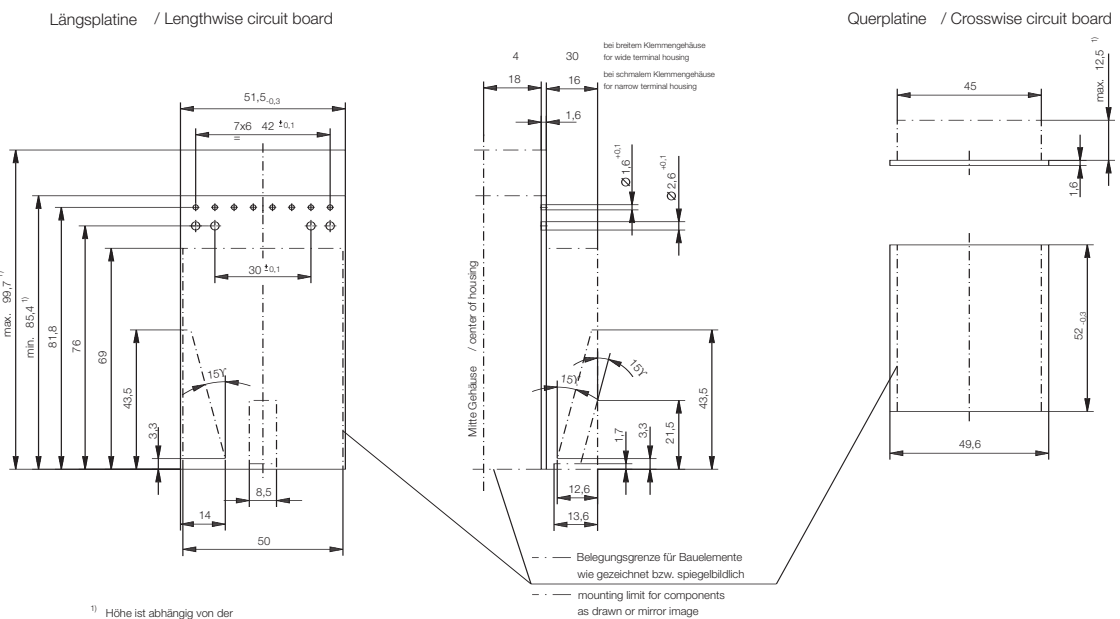

¹⁾ Höhe ist abhängig von der Einbaulage der Querplatine
¹⁾ height depends on location of the crosswise circuit board

Achtung: Im Eckenbereich verringerte Einbauhöhen
Note: reduced space for components in the corner area

all dimensions in mm

Enclosures LDG-A

LDG-A 30

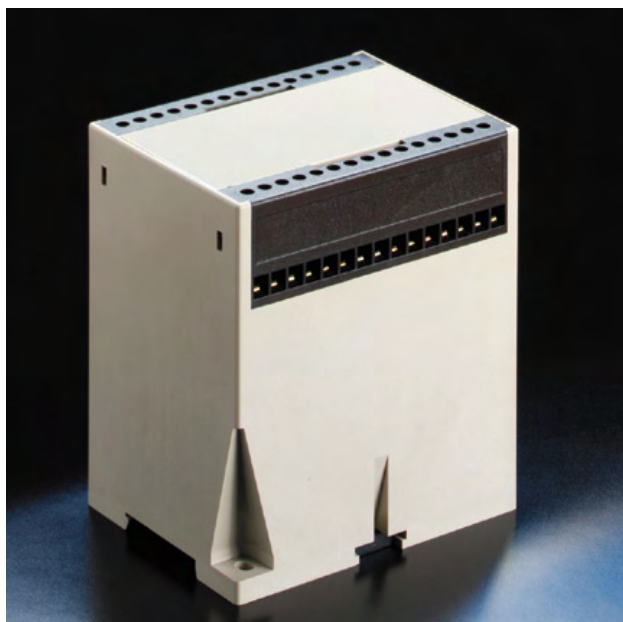

- For max. 30 screw clamp terminals, 15 on each side
- Partial loaded terminal blocks with blind plugs
- PCB board arrangement see drawing

Usage of standard connectors

- Special frames for pluggable standard connectors available
- Pitch of 5.08 mm allows connection of 17 wires on each side

Length: 75 mm
Width: 99.7 mm
Height: 110 mm

Ordering information

Description	Type	Color	Part Number
Base part	w/o ventilation slots	light grey	414165
Base part	with ventilation slots	light grey	434098
Cover		light grey	413962
Cover		transparent	413963
Cover		black	413964
Terminal block housing	narrow	black	413966
Terminal block housing	narrow	blue	413965
Terminal block housing	wide	black	413968
Terminal block housing	wide	blue	413967
Terminal pin	short		224076
Terminal pin	long		224074
Clamp, not assembled			154562
Terminal block, fully loaded	narrow	black	914850
Terminal block, fully loaded	wide	black	914860
Blind plug		black	103006
Frame insert for pluggable connectors	Top cutout	black	034769
Frame insert for pluggable connectors	Bottom cutout	black	053164
Blind plug		black	053074

ERMEC, S.L. BARCELONA
C/ Francesc Teixidó, 22
E-08918 Badalona
(Spain)

Tel.: (+34) 902 450 160
Fax: (+34) 902 433 088
info@ermec.com
www.ermec.com

ERMEC, S.L. MADRID
C/ Sagasta, 8, 1ª planta
E-28004 Madrid
(Spain)

PORTUGAL
portugal@ermec.com
BILBAO
bilbao@ermec.com

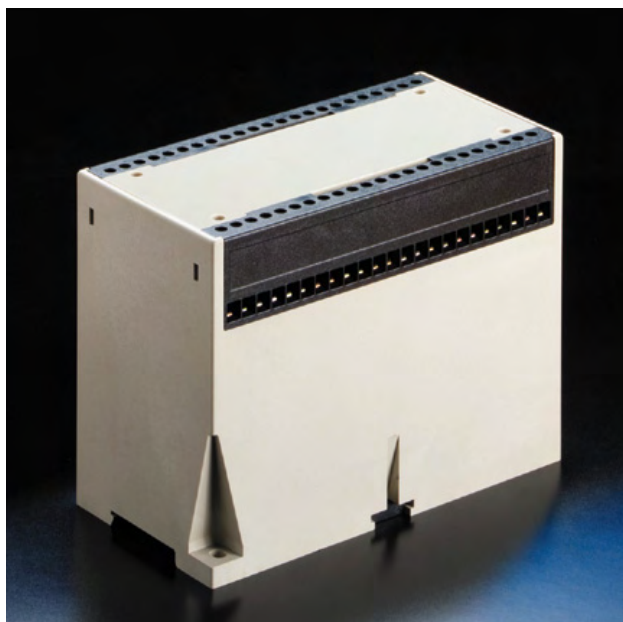

- For max. 46 screw clamp terminals, 23 on each side
- Partial loaded terminal blocks with blind plugs
- PCB board arrangement see drawing

Usage of standard connectors

- Special frames for pluggable standard connectors available
- Pitch of 5.08 mm allows connection of 26 wires on each side

Length: 75 mm
Width: 150 mm
Height: 110 mm

Ordering information

Description	Type	Color	Part Number
Base part	w/o ventilation slots	light grey	024078
Base part	with ventilation slots	light grey	024080
Cover		light grey	014818
Cover		transparent	014819
Cover		black	014820
Terminal block housing	narrow	black	014649
Terminal block housing	wide	black	014790
Terminal pin	short	black	224076
Terminal pin	long	black	224074
Clamp, not assembled			154562
Terminal block, fully loaded	narrow	black	914890
Terminal block, fully loaded	wide	black	914900
Blind plug		black	103006
Frame insert for pluggable connectors	Bottom cutout	black	054248
Blind plug		black	054249

ERMEC, S.L. BARCELONA
C/ Francesc Teixidó, 22
E-08918 Badalona
(Spain)

Tel.: (+34) 902 450 160
Fax: (+34) 902 433 088
info@ermec.com
www.ermec.com

ERMEC, S.L. MADRID
C/ Sagasta, 8, 1ª planta
E-28004 Madrid
(Spain)

PORTUGAL
portugal@ermec.com
BILBAO
bilbao@ermec.com

Enclosures LDG-A

LDG-A 70

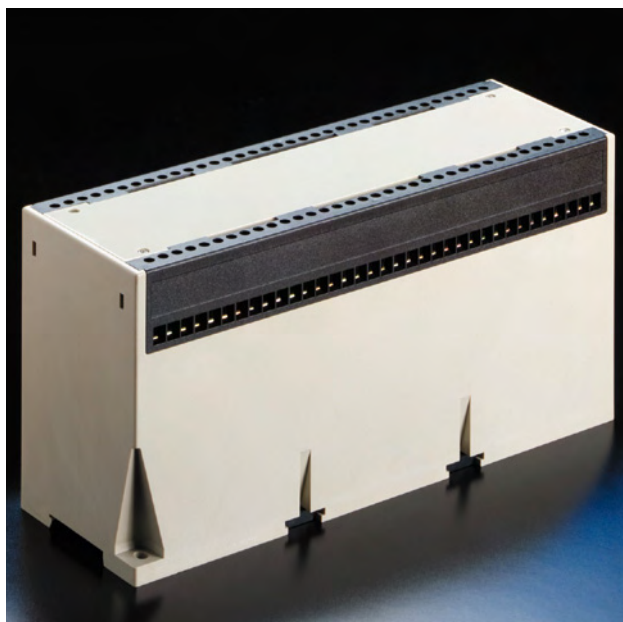

- For max. 70 screw clamp terminals, 35 on each side, clamp pitch 6 mm
- Partial loaded terminal blocks with blind plugs
- PCB board arrangement see drawing

Usage of standard connectors

- Special frames for pluggable standard connectors available
- Pitch of 5.08 mm allows connection of 41 wires on each side

Length: 75 mm
 Width: 225 mm
 Height: 110 mm

Ordering information

Description	Type	Color	Part Number
Base part	w/o ventilation slots	light grey	424327
Base part	with ventilation slots	light grey	424328
Cover		light grey	424243
Cover		transparent	424244
Cover		black	424245
Terminal block housing	narrow	black	424240
Terminal block housing	narrow	blue	424239
Terminal block housing	wide	black	424242
Terminal block housing	wide	blue	424241
Terminal pin	short		224076
Terminal pin	long		224074
Clamp, not assembled			154562
Terminal block, fully loaded	narrow	black	914870
Terminal block, fully loaded	wide	black	914880
Blind plug		black	103006
Blind plug		black	054730

ERMEC, S.L. BARCELONA
 C/ Francesc Teixidó, 22
 E-08918 Badalona
 (Spain)

Tel.: (+34) 902 450 160
Fax: (+34) 902 433 088
info@ermec.com
www.ermec.com

ERMEC, S.L. MADRID
 C/ Sagasta, 8, 1ª planta
 E-28004 Madrid
 (Spain)

PORTUGAL
portugal@ermec.com
BILBAO
bilbao@ermec.com

Dimensions

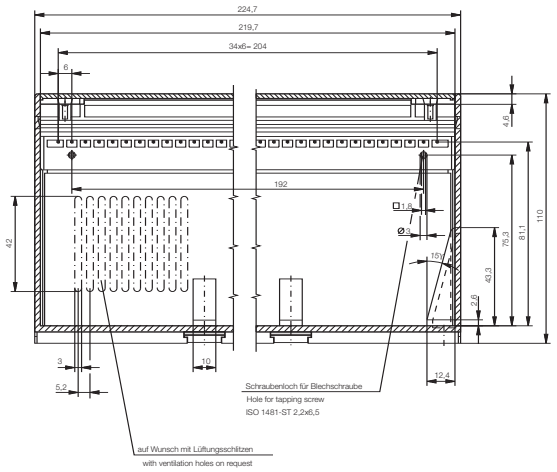
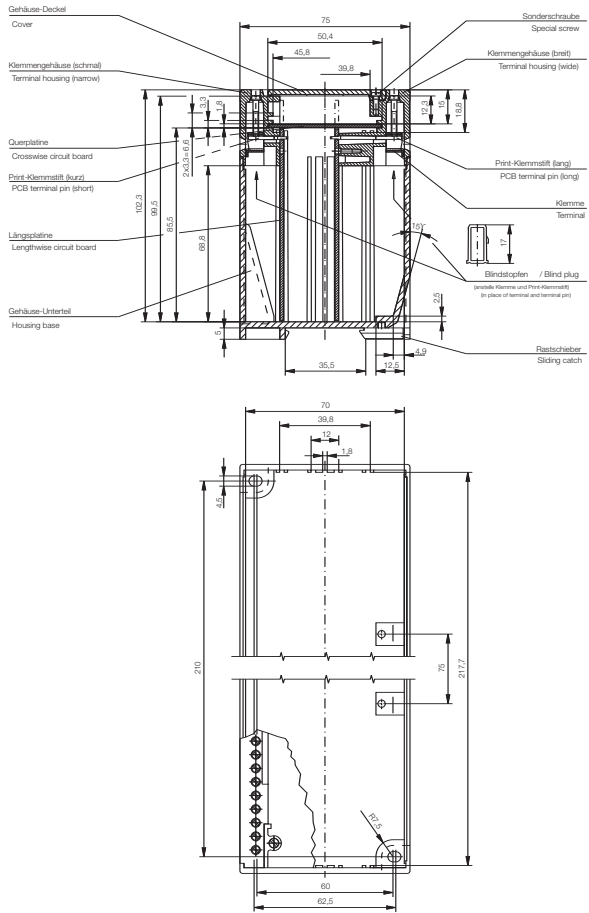

all dimensions in mm

Recommended PCB dimensions

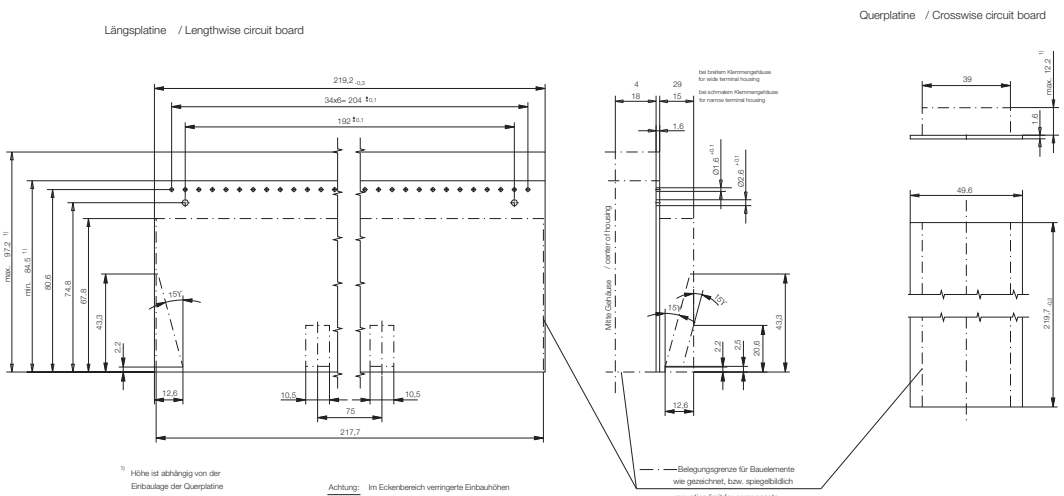

¹⁾ Höhe ist abhängig von der Einbautiefe der Querplatte
²⁾ height depends on location of

Achtung: Im Eckenbereich verringerte Einbautiefen
Note: reduced space for components in the corner area

all dimensions in mm

ERMEC, S.L. BARCELONA
C/ Francesc Teixidó, 22
E-08918 Badalona
(Spain)

Tel.: (+34) 902 450 160
Fax: (+34) 902 433 088
info@ermec.com
www.ermec.com

ERMEC, S.L. MADRID
C/ Sagasta, 8, 1ª planta
E-28004 Madrid
(Spain)

PORTUGAL
portugal@ermec.com
BILBAO
bilbao@ermec.com

**ERNI Electronics GmbH**

Seestrasse 9
73099 Adelberg/Germany
Tel +49 7166 50-0
Fax +49 7166 50-282
info@erni.de

Europe South America Africa Japan

ERNI Electronics, Inc.

2201 Westwood Ave
Richmond, VA 23230/USA
Tel +1 804 228-4100
Fax +1 804 228-4099
info@erni.us

North America Canada Mexico

ERNI Asia Holding Pte Ltd.

Blk 4008 Ang Mo Kio Avenue 10
#04-01/02 Techplace I
Singapore 569625
Tel +65 6 555 5885
Fax +65 6 555 5995
info@erni-asia.com

Asia

ERMEC, S.L. BARCELONA
C/ Francesc Teixidó, 22
E-08918 Badalona
(Spain)



Tel.: (+34) 902 450 160
Fax: (+34) 902 433 088
info@ermec.com
www.ermec.com

ERMEC, S.L. MADRID
C/ Sagasta, 8, 1ª planta
E-28004 Madrid
(Spain)

PORTUGAL
portugal@ermec.com
BILBAO
bilbao@ermec.com

www.erni.com

© ERNI Electronics GmbH 2010 • Printed in Germany. A policy of continuous improvement is followed and the right to alter any published data without notice is reserved.
ERNI®, MicroStac®, MicroSpeed®, MiniBridge®, MaxiBridge®, ERmet®, ERmet ZD®, ERbic® and ERNIPRESS® are trademarks (registered or applied for in various countries) of ERNI Electronics GmbH.