



LDG-S Enclosures for DIN-rails

ERMEC, S.L. BARCELONA
C/ Francesc Teixidó, 22
E-08918 Badalona
(Spain)



Tel.: (+34) 902 450 160
Fax: (+34) 902 433 088
info@ermec.com
www.ermec.com

ERMEC, S.L. MADRID
C/ Sagasta, 8, 1ª planta
E-28004 Madrid
(Spain)

PORTUGAL
portugal@ermec.com
BILBAO
bilbao@ermec.com

ERMEC, S.L. BARCELONA
 C/ Francesc Teixidó, 22
 E-08918 Badalona
 (Spain)



Tel.: (+34) 902 450 160
 Fax: (+34) 902 433 088
info@ermec.com
www.ermec.com

ERMEC, S.L. MADRID
 C/ Sagasta, 8, 1ª planta
 E-28004 Madrid
 (Spain)

PORTUGAL
portugal@ermec.com
 BILBAO
bilbao@ermec.com

LDG-S Enclosure for DIN-rails

Table of Contents



General2
3D View3
Dimensions4
PCB Dimensions5
Technical Data7
LDG-S2 Ordering Information8
LDG-S4 Ordering Information10
Part Number Index12

ERMEC, S.L. BARCELONA
C/ Francesc Teixidó, 22
E-08918 Badalona
(Spain)



www.ermec.com
Distribución de componentes
eléctricos y electrónicos

Tel.: (+34) 902 450 160
Fax: (+34) 902 433 088
info@ermec.com
www.ermec.com

ERMEC, S.L. MADRID
C/ Sagasta, 8, 1ª planta
E-28004 Madrid
(Spain)

PORTUGAL
portugal@ermec.com
BILBAO
bilbao@ermec.com



The LDG-S serie of enclosures are fully insulated enclosures according to the specifications of the machinery and the automotive industries.

Designed for easy snap-on assembly onto DIN-rails by integrated snap-on clip. These enclosures facilitate economical device assembly with optimal utilization of space. For the termination of the conductors of the cable 2 enclosure versions are available:

- pluggable terminals for easy servicing and exchange (commercial pin headers on the pcb).
 - screw terminals for a fixed termination of the conductors.
- For effective heat dissipation the LDG-S enclosure features a base part with integrated ventilation slots. Closed versions (without ventilation slot) are available upon request.

Technical Features

- 2 installation widths: LDG-S2: 22.5 mm
LDG-S4: 45 mm
- Options for the termination of the conductors:
 - LDG-S2: 4 screw terminal blocks with 4 terminals each
or
4 pcb headers with 4 pin contacts each for connecting cable connectors with 4 pins
 - LDG-S4: 8 screw terminal blocks with 4 terminals each
or
8 pcb headers with 4 pin contacts each for connecting cable connectors with 4 pins
- Easy snap-on assembly on DIN-rails according to DIN EN 50 022
- Easy assembly of the enclosure achieved by snap-in design of the two base part and the top part
- Transparent housing cover with the option for a label
- Customized colors and versions upon request

ERMEC, S.L. BARCELONA
 C/ Francesc Teixidó, 22
 E-08918 Badalona
 (Spain)



Tel.: (+34) 902 450 160
Fax: (+34) 902 433 088
info@ermec.com
www.ermec.com

ERMEC, S.L. MADRID
 C/ Sagasta, 8, 1ª planta
 E-28004 Madrid
 (Spain)

PORTUGAL
portugal@ermec.com
BILBAO
bilbao@ermec.com

LDG-S Enclosure for DIN-rails

3 D View



LDG-S2: Version with screw termination

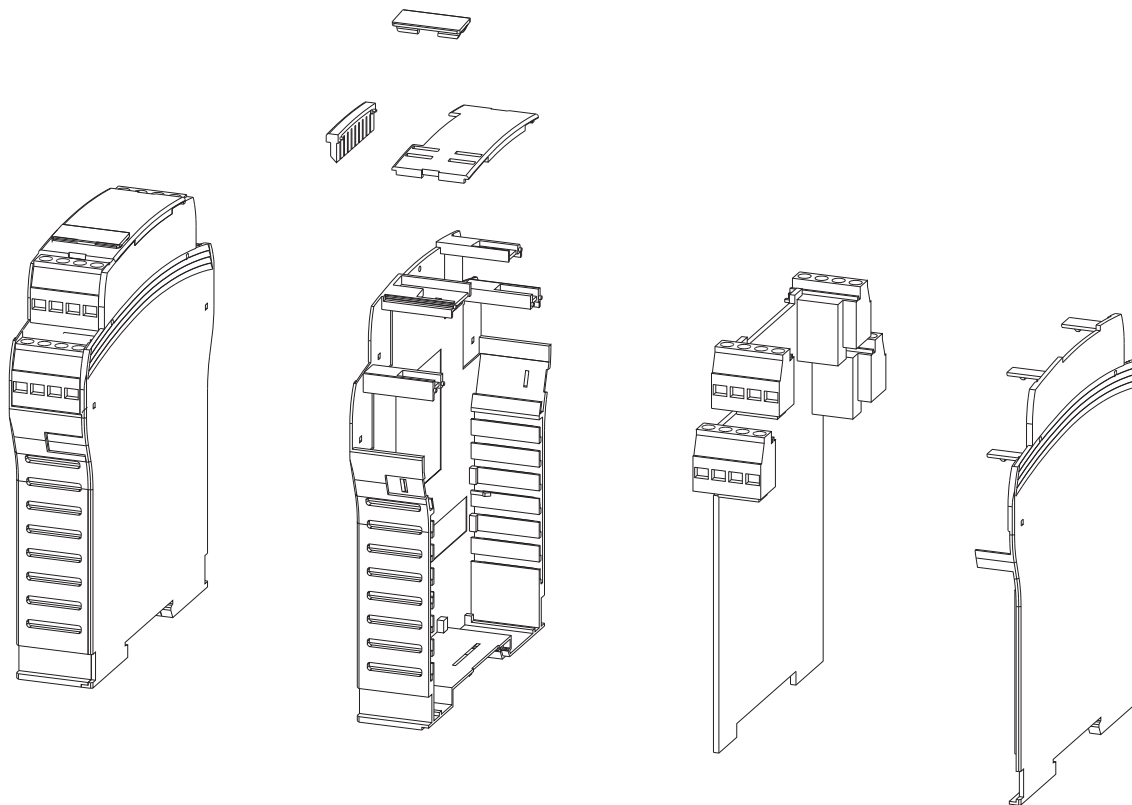

LDG-S4: Version with screw termination

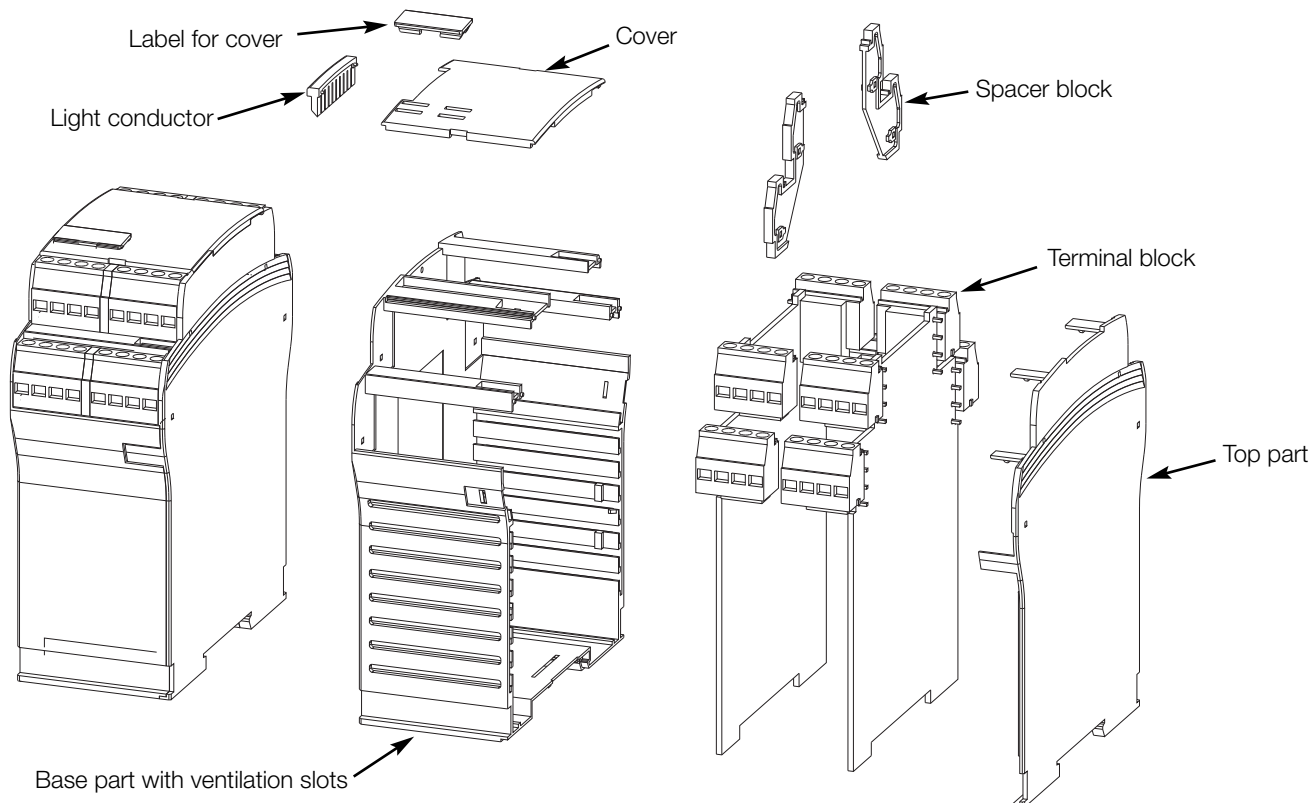

LDG-S Enclosure for DIN-rails

Dimensions



LDG-S2

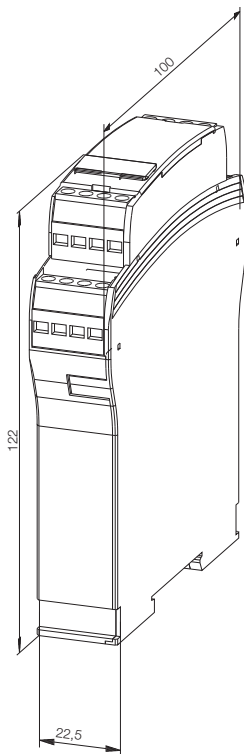

LDG-S4

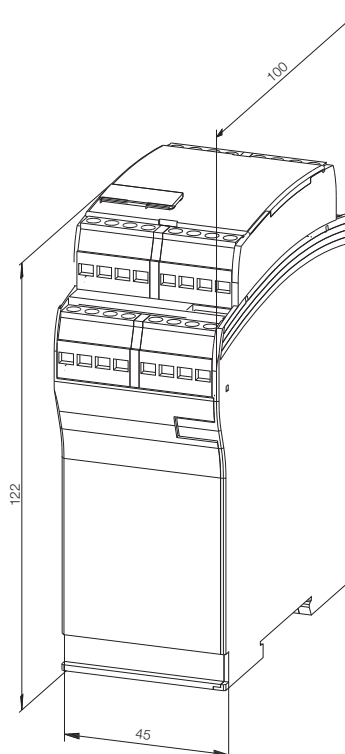

ERMEC, S.L. BARCELONA
C/ Francesc Teixidó, 22
E-08918 Badalona
(Spain)



Tel.: (+34) 902 450 160
Fax: (+34) 902 433 088
info@ermec.com
www.ermec.com

ERMEC, S.L. MADRID
C/ Sagasta, 8, 1ª planta
E-28004 Madrid
(Spain)

PORTUGAL
portugal@ermec.com
BILBAO
bilbao@ermec.com

LDG-S Enclosure for DIN-rails

PCB Dimensions



LDG-S2

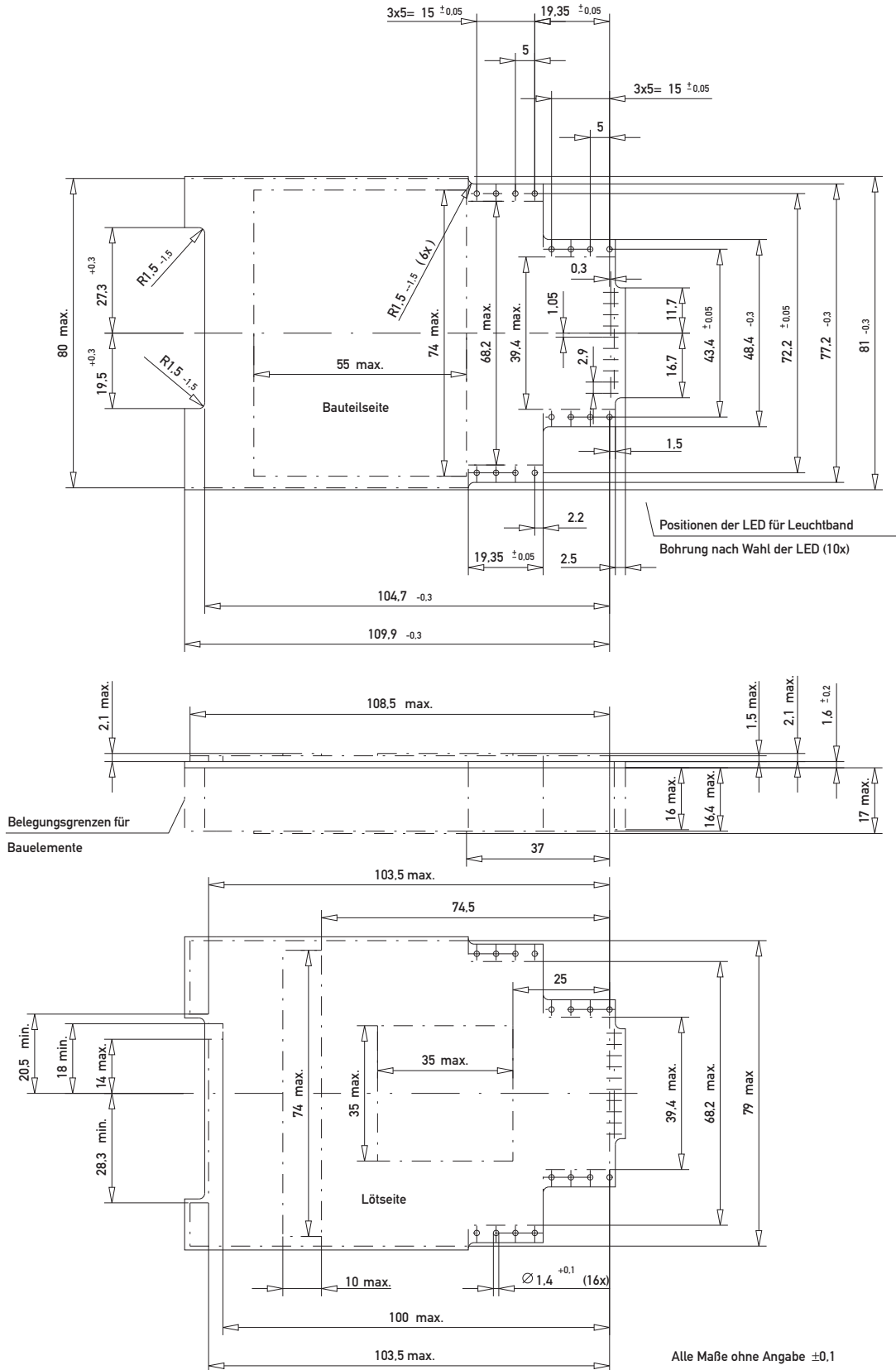



LDG-S Enclosure for DIN-rails

Tecnical Data



Versions	LDG-S2, LDG-S4
Degree of protection	IP 40
Air- and creepage distance acc. IEC 60 664 for terminalblock	3.2 mm
Comparative figure of voltage acc. IEC 112	Terminalblock CTI 250
Insulation material acc. IEC 60 664	Class III
Current rating terminal / pin headers	max. 10 A
Cable diameter terminal /connector cross section	max. 2.5 mm ²
Materials	
Base part	Thermoplastic, UL 94 V-0
Top part	Thermoplastic, UL 94 V-0
Cover	Thermoplastic, UL 94 V-1
Transparente Cover	Thermoplastic, UL 94 V-2
Terminal / pin headers	Thermoplastic, UL 94 V-0
Terminal pin Base material / plating	Cu-alloy / tinned
Label for cover	PVC
Temperature range	-40 °C ... +85 °C

Dissipation loss (P_v) at 20°C ambient air temperature (t_u) in enclosures with ventilation slots

	LDG-S2	LDG-S4
 exposed	10 W	10 W
 in-line w/o space	7 W	8 W

Correction factor for upper ambient air temperature (P_{v+u} = P_{v 20°C} x F)

t _u	20	30	40	50	60
F	1	0.9	0.8	0.7	0.55

ERMEC, S.L. BARCELONA
 C/ Francesc Teixidó, 22
 E-08918 Badalona
 (Spain)



Tel.: (+34) 902 450 160
 Fax: (+34) 902 433 088
info@ermec.com
www.ermec.com

ERMEC, S.L. MADRID
 C/ Sagasta, 8, 1ª planta
 E-28004 Madrid
 (Spain)

PORTUGAL
portugal@ermec.com
 BILBAO
bilbao@ermec.com

LDG-S Enclosure for DIN-rails

LDG-S2 with Screw Terminal Blocks



Order list for complete enclosure and individual components

Description	Color	Termination	Part Number
Complete kit	black	screw terminal block	223119

Components of the complete kit

Description	Color	Quantity	Part Number
Base part with ventilation slots*	black	1	134209
Top part	black	1	134226
Screw terminal block left, 4pin	black	2	144008
Screw terminal block right, 4pin	black	2	144009
Cover	black	1	144149
Label	white	1	134577

Additional components

Description	Color	Quantity	Part Number
Cover	transparent	1	134575
Cover, LED	black	1	144151
Light conductor	transparent	1	134244

*Base part w/o ventilation slots on request

ERMEC, S.L. BARCELONA
C/ Francesc Teixidó, 22
E-08918 Badalona
(Spain)



Tel.: (+34) 902 450 160
Fax: (+34) 902 433 088
info@ermec.com
www.ermec.com

ERMEC, S.L. MADRID
C/ Sagasta, 8, 1ª planta
E-28004 Madrid
(Spain)

PORTUGAL
portugal@ermec.com
BILBAO
bilbao@ermec.com

LDG-S Enclosure for DIN-rails

LDG-S2 with Pluggable Screw Terminal Blocks



Order list for complete enclosure and individual components

Description	Color	Termination	Part Number
Complete kit	black	pluggable screw terminal block	223120

Components of the complete kit

Description	Color	Quantity	Part Number
Base part with ventilation slots*	black	1	134213
Top part	black	1	134226
Pcb header left, 4pin	black	2	144011
Pcb header right, 4pin	black	2	144012
Pluggable screw terminal block, 4pin	black	4	144010
Cover	black	1	144149
Label	white	1	134577

Additional components

Description	Color	Quantity	Part Number
Cover	transparent	1	134575
Cover, LED	black	1	144151
Light conductor	transparent	1	134244

*Base part w/o ventilation slots on request

ERMEC, S.L. BARCELONA
C/ Francesc Teixidó, 22
E-08918 Badalona
(Spain)

Tel.: (+34) 902 450 160
Fax: (+34) 902 433 088
info@ermec.com
www.ermec.com

ERMEC, S.L. MADRID
C/ Sagasta, 8, 1ª planta
E-28004 Madrid
(Spain)

PORTUGAL
portugal@ermec.com
BILBAO
bilbao@ermec.com

LDG-S Enclosure for DIN-rails

LDG-S4 with Screw Terminal Blocks



Order list for complete enclosure and individual components

Description	Color	Termination	Part Number
Complete kit	black	screw terminal block	223121

Components of the complete kit

Description	Color	Quantity	Part Number
Base part with ventilation slots*	black	1	134217
Top part	black	1	134226
Screw terminal block left, 4pin	black	4	144008
Screw terminal block right, 4pin	black	4	144009
Spacer block	black	2	144166
Cover	black	1	144152
Label	white	1	134577

Additional components

Description	Color	Quantity	Part Number
Cover	transparent	1	134573
Cover, LED	black	1	144154
Light conductor	transparent	1	134244

*Base part w/o ventilation slots on request



ERMEC, S.L. BARCELONA
 C/ Francesc Teixidó, 22
 E-08918 Badalona
 (Spain)

Tel.: (+34) 902 450 160
Fax: (+34) 902 433 088
info@ermec.com
www.ermec.com

ERMEC, S.L. MADRID
 C/ Sagasta, 8, 1ª planta
 E-28004 Madrid
 (Spain)

PORTUGAL
portugal@ermec.com
BILBAO
bilbao@ermec.com

LDG-S Enclosure for DIN-rails

LDG-S4 with Pluggable Screw Terminal Blocks



Order list for complete enclosure and individual components

Description	Color	Termination	Part Number
Complete kit	black	Pluggable screw terminal block	223122

Components of the complete kit

Description	Color	Quantity	Part Number
Base part with ventilation slots*	black	1	134221
Top part	black	1	134226
Pcb header left, 4pin	black	4	144011
Pcb header right, 4pin	black	4	144012
Pluggable screw terminal block, 4pin	black	8	144010
Spacer block	black	2	144168
Cover	black	1	144152
Label	white	1	134577

Additional components

Description	Color	Quantity	Part Number
Cover	transparent	1	134573
Cover, LED	black	1	144154
Light conductor	transparent	1	134244

*Base part w/o ventilation slots on request

ERMEC, S.L. BARCELONA
C/ Francesc Teixidó, 22
E-08918 Badalona
(Spain)

Tel.: (+34) 902 450 160
Fax: (+34) 902 433 088
info@ermec.com
www.ermec.com

ERMEC, S.L. MADRID
C/ Sagasta, 8, 1ª planta
E-28004 Madrid
(Spain)

PORTUGAL
portugal@ermec.com
BILBAO
bilbao@ermec.com

LDG-S Enclosure for DIN-rails

Part Number Index



Part Number	Page
134209	8
134213	9
134217	10
134221	11
134226	8, 9, 10, 11
134244	8, 9, 10, 11
134573	10, 11
134575	8, 9
134577	8, 9, 10, 11
144008	8, 10
144009	8, 10
144010	9, 11
144011	9, 11
144012	9, 11
144149	8, 9
144151	8, 9
144152	10, 11
144154	10, 11
144166	10
144168	11
223119	8
223120	9
223121	10
223122	11

ERMEC, S.L. BARCELONA
C/ Francesc Teixidó, 22
E-08918 Badalona
(Spain)



Tel.: (+34) 902 450 160
Fax: (+34) 902 433 088
info@ermec.com
www.ermec.com

ERMEC, S.L. MADRID
C/ Sagasta, 8, 1ª planta
E-28004 Madrid
(Spain)

PORTUGAL
portugal@ermec.com
BILBAO
bilbao@ermec.com



Member



VMEbus INTERNATIONAL TRADE ASSOCIATION



ERMEC, S.L. BARCELONA
 C/ Francesc Teixidó, 22
 E-08918 Badalona
 (Spain)



Tel.: (+34) 902 450 160
Fax: (+34) 902 433 088
info@ermec.com
www.ermec.com

ERMEC, S.L. MADRID
 C/ Sagasta, 8, 1ª planta
 E-28004 Madrid
 (Spain)

PORTUGAL
portugal@ermec.com
BILBAO
bilbao@ermec.com

**ERNI Electronics GmbH**

Seestrasse 9
73099 Adelberg/Germany
Tel +49 7166 50-0
Fax +49 7166 50-282
info@erni.de

Europe South America Africa Japan

ERNI Electronics, Inc.

2201 Westwood Ave
Richmond, VA 23230/USA
Tel +1 804 228-4100
Fax +1 804 228-4099
info.usa@erni.com

North America Canada Mexico

ERNI Asia Holding Pte Ltd.

Blk 4008 Ang Mo Kio Avenue 10
#04-01/02 Techplace I
Singapore 569625
Tel +65 6 555 5885
Fax +65 6 555 5995
info@erni-asia.com

Asia

ERMEC, S.L. BARCELONA
C/ Francesc Teixidó, 22
E-08918 Badalona
(Spain)



Tel.: (+34) 902 450 160
Fax: (+34) 902 433 088
info@ermec.com
www.ermec.com

ERMEC, S.L. MADRID
C/ Sagasta, 8, 1ª planta
E-28004 Madrid
(Spain)

PORTUGAL
portugal@ermec.com
BILBAO
bilbao@ermec.com

www.erni.com

© ERNI Electronics GmbH 2009 • Printed in Germany. A policy of continuous improvement is followed and the right to alter any published data without notice is reserved.
ERNI®, MicroStac®, MicroSpeed®, MiniBridge®, MaxiBridge®, ERmet®, ERmet ZD®, ERbic® and ERNIPRESS® are trademarks (registered or applied for in various countries) of ERNI Electronics GmbH.