



1.27 mm Connectors SMC

www.erni.com

ERMEC, S.L. BARCELONA
C/ Francesc Teixidó, 22
E-08918 Badalona
(Spain)



Tel.: (+34) 902 450 160
Fax: (+34) 902 433 088
info@ermec.com
www.ermec.com

ERMEC, S.L. MADRID
C/ Sagasta, 8, 1ª planta
E-28004 Madrid
(Spain)

PORTUGAL
portugal@ermec.com
BILBAO
bilbao@ermec.com

ERNI



www.erni.com

ERMEC, S.L. BARCELONA
C/ Francesc Teixidó, 22
E-08918 Badalona
(Spain)



Tel.: (+34) 902 450 160
Fax: (+34) 902 433 088
info@ermec.com
www.ermec.com

ERMEC, S.L. MADRID
C/ Sagasta, 8, 1ª planta
E-28004 Madrid
(Spain)

PORTUGAL
portugal@ermec.com
BILBAO
bilbao@ermec.com

1.27 mm Connectors SMC

Table of Contents

Applications	.2
Technical Features	.3
SMC at a Glance	.4
Mating Conditions	.6
Stacking Dimensions	.7
Overhead Soldering	.8
ERNIPRESS® Technology	.9
Board-on IDC Assembly Instructions	.10
Electrical and Mechanical Characteristics	.11
Right Angle Male Type B	.14
Right Angle Male Type B with Locking System	.16
Vertical Male Type Q	.18
Vertical Male Pressfit Type Q	.22
Right Angle Female Type Q	.24
Right Angle Female Type Q with Locking System	.26
Vertical Female Type B	.28
Board-on IDC	.33
Female Cable Assemblies	.36
Part Number Index	.38



1.27 mm Connectors SMC

Applications



Motherboard to daughter card in an ISDN equipment

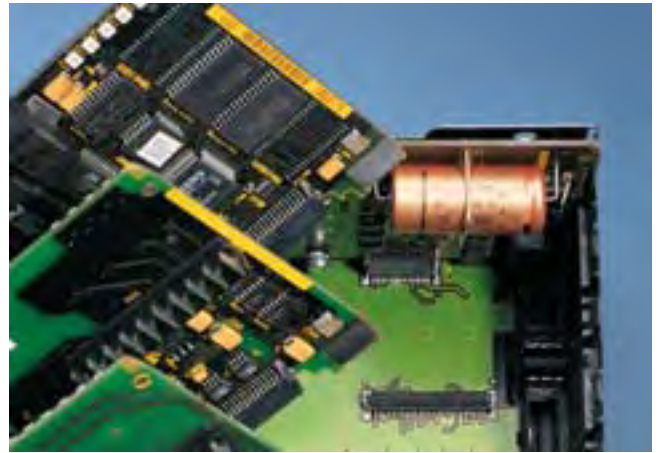

Motherboard to daughter card for industrial PLCs



Mezzanine cards in mobile phone test equipment



Mezzanine cards for industrial automation

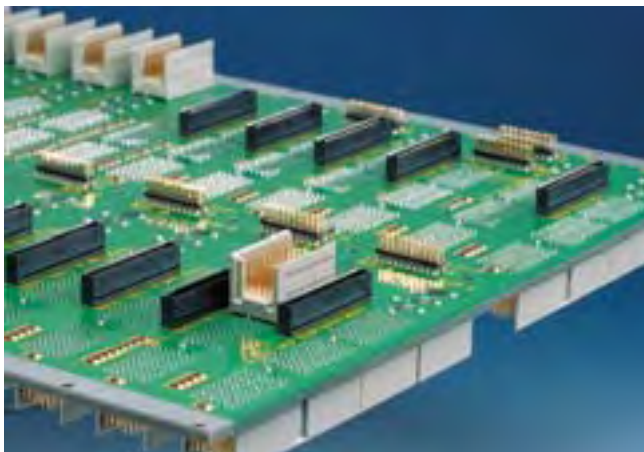

Board to cable for video coding backplane



Versatile configurations in an industrial controller



1.27 mm Connectors SMC

Technical Features



Board-to-board and board-to-cable applications



Wide entry area alignment tolerance



Polarization of the mating face

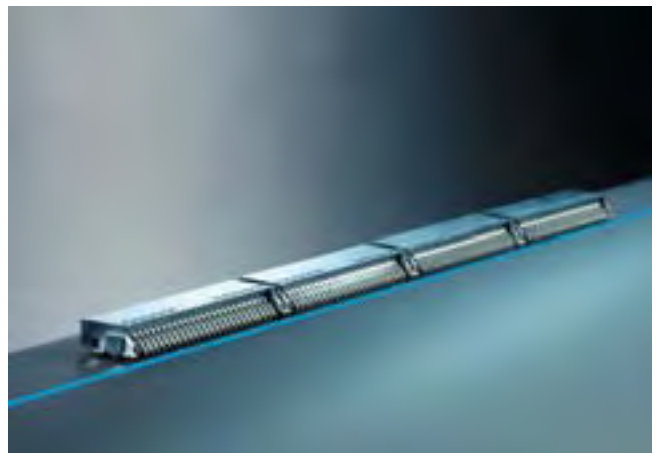

Guaranteed coplanarity



Various pin versions



Rear I/O pressfit connectors on backplanes



1.27 mm Connectors SMC

SMC at a Glance



Subassembly Design - Flexibility in Application

Straight and right angle male and female connectors, and other available options permit many configurations and variations for maximum flexibility in designing modules and manufacturing boards.

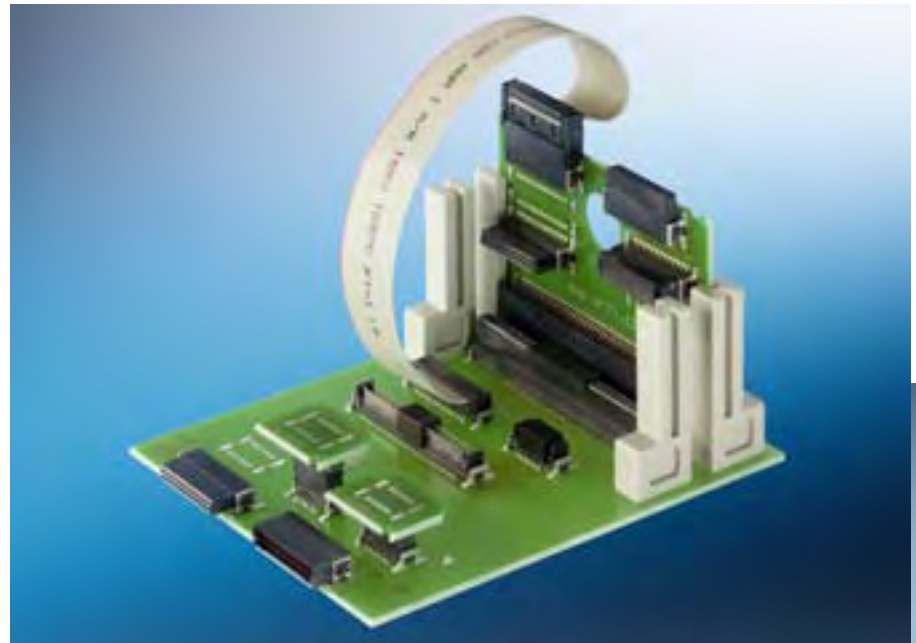

Solution of Choice for Modern Subassembly Applications

Printed circuit board solutions for all kind of branches.



Rear I/O connector on Multi-layer Backplanes

The pressfit versions of the SMC male connectors are ideal for transferring I/O signals on the rear side of a backplane.



Variable Board-to-Board Height

Flexible Board-to-Board heights ranging from 8.0 mm to 20.0 mm for subassembly solutions.



Simple I/O Signal Transfer with "Snap-Lock" Female Cable Connector

The female IDC cable connectors with snap-lock feature make transferring I/O signals easy and also saves space by eliminating the need for ejector latches.



1.27 mm Connectors SMC

SMC at a Glance



Completely Automated Manufacturing of SMC Connectors

SMC connectors are manufactured using controlled state of the art automated manufacturing equipment.

Controlled SMT Reflow Soldering Process

The heat-resistant thermoplastic insulation body and precision coplanar contacts permit a controlled SMT soldering process.



Reliable Insertion and Removal

The metal SMT mounting clip ensures a reliable connection to the printed circuit board. As a result of its special design, it can handle high insertion and withdrawal forces. The integrated metal clips are soldered during the SMT process, thus eliminating the need for an additional operation such as rivets.



Quality Check

A full inspection of the female contact apertures and coplanarity of our SMC connectors guarantees maximum reliability for your printed circuit boards.



Easy Recognition and Secure Handling

The black insulation body ensures easy visual recognition by the automatic pick and place equipment.

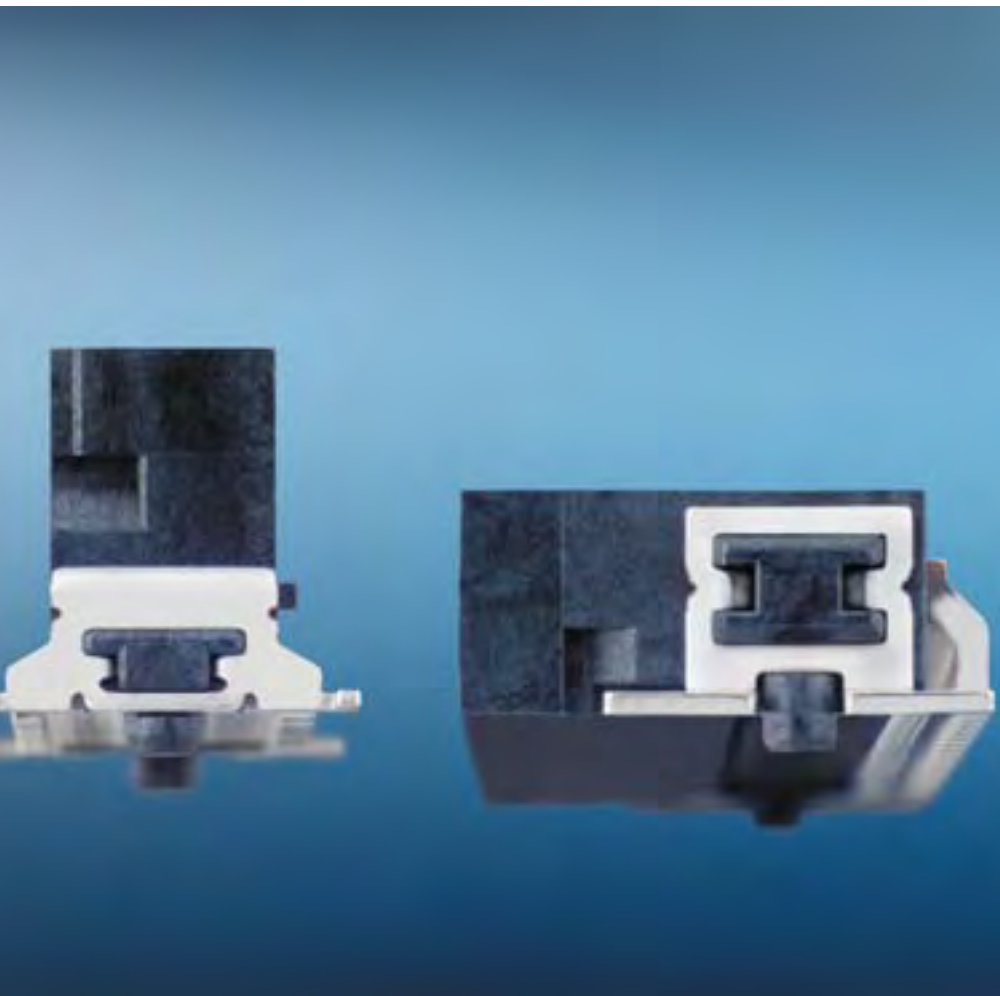

Safe Packaging for Fully Automated Assembly

The antistatic tape and reel packaging not only protects the high-precision contacts of our SMC connectors, but also permits placement of connectors by automated pick and place equipment.

1.27 mm Connectors SMC

Mating Conditions

Allowed misalignment tolerances longitudinal and transverse axes: ± 0.7 mm

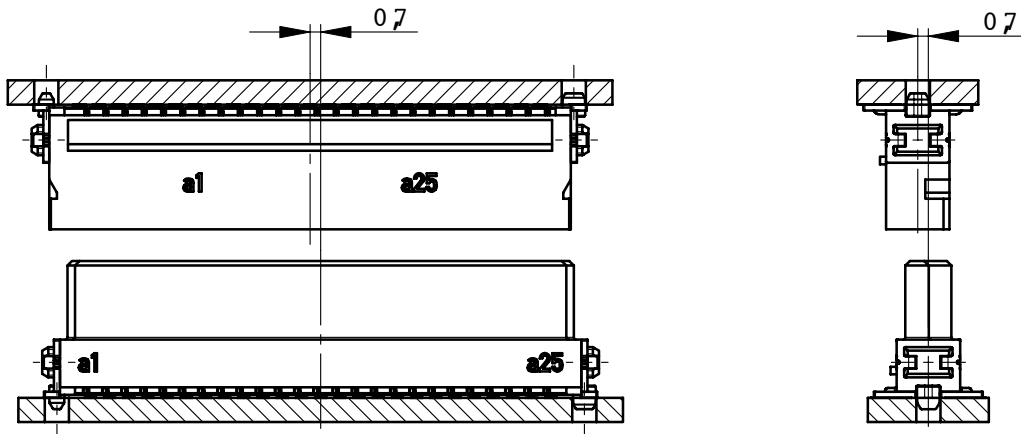

Allowed angular inclination tolerances longitudinal: $\pm 4^\circ$; transverse: $\pm 2^\circ$

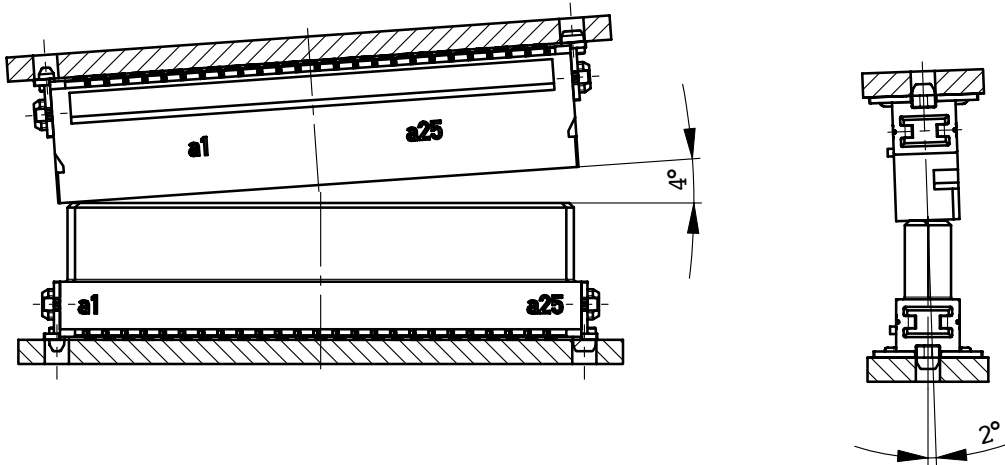

Wipe length 1.5 mm / Board-to-Board distance 8-20 mm

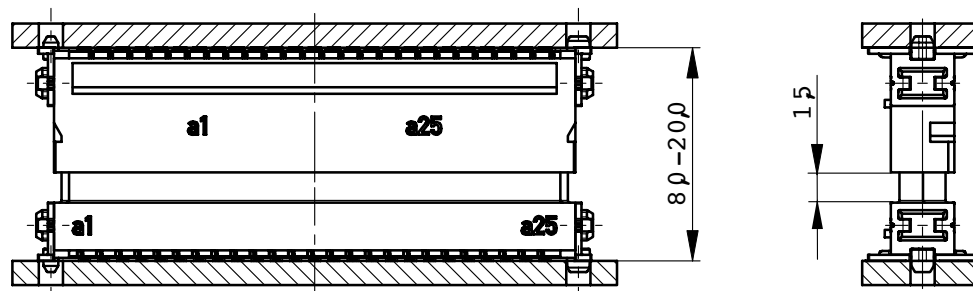

All dimensions in mm

1.27 mm Connectors SMC

Stacking Dimensions

Mezzanine

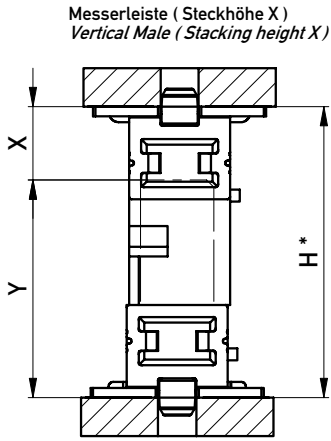

X	Y	H*
1.75	6.25	8.00 - 9.50
3.25	6.25	9.50 - 11.00
1.75	9.05	10.80 - 12.30
3.25	9.05	12.30 - 13.80
4.85	9.05	13.90 - 15.40
1.75	13.65	15.40 - 16.90
3.25	13.65	16.90 - 18.40
4.85	13.65	18.50 - 20.00

* Maximum Board-to-Board height is achieved taking 1.5 mm wipe length in account.

Extender card

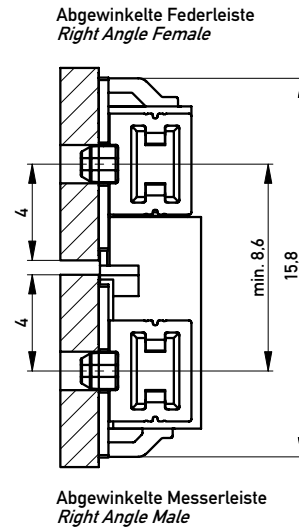

Motherboard to daughter card

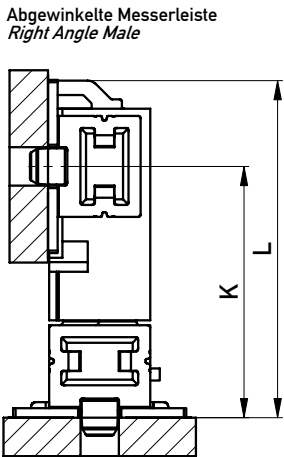

K _{min.}	L	M
7.65	11.25	6.25
10.45	14.05	9.05
15.05	18.65	13.65

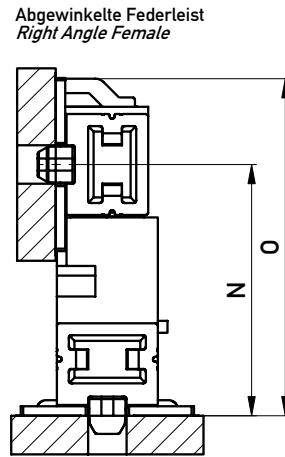

N _{min.}	O	P
8.95	12.55	1.75
10.45	14.05	3.25
12.05	15.65	4.85

Ordering Information

Pressfit Tooling for Male Connectors

Design	Type	Comment	Upper Tool Part Number	Lower Tool Part Number
Vertical Male 12 pin Pressfit	Q Standard Assembly Height	with Quick Change	220160	220165
Vertical Male 26 pin Pressfit	Q Standard Assembly Height	with Quick Change	220162	220167
Vertical Male 50 pin Pressfit	Q Standard Assembly Height	with Quick Change	220164	220169
Vertical Male 68 pin Pressfit	Q Standard Assembly Height	with Quick Change	220644	220645
Vertical Male 80 pin Pressfit	Q Standard Assembly Height	with Quick Change	220646	220647

Hole Design

Schichtaufbau im metallisierten Loch für EN*-Kontakt
Metal plating of plated-through hole for EN*-contact

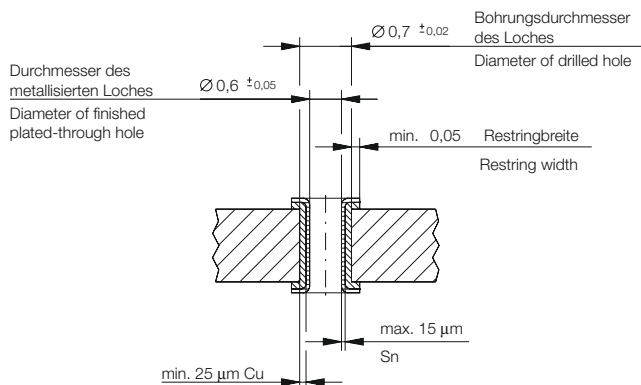

* EN = ERNI Nadelöhr / ERNI eye of the needle

1.27 mm Connectors SMC

Board-on IDC Assembly Instructions

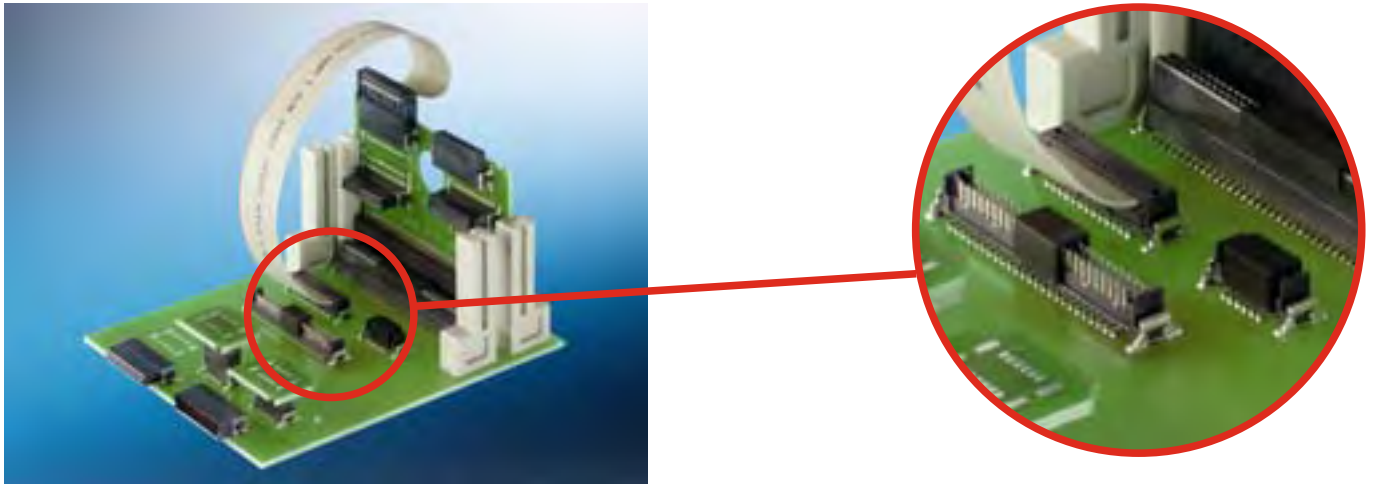

ERNI's Board-on IDC system offers the possibility to optimize cable connections in two ways. The compact size reduces the required area on the board and it is more cost effective than a conventional female – male connection.

Note that the Board-on IDC connector is to be soldered to the PCB before assembling the cable.

ERNI recommends the following:

- A layout proposal indicating the restricted area.
- Use upper and lower tooling to assemble the cable to the connector. Use a flat upper tool which covers the cable guide and is mounted to the press ram and a lower tool that completely supports the area beneath the connector assembly.
- Insert the entire PCB into a fixture for the best results so that one may concentrate on the operation of the press and holding the cable. The fixture should be fixed to the press base and have a method of aligning the PCB within the fixture using the perimeter of the PCB and/or alignment pins.
- Important consideration must be given to the assembly tools available. When using a hand lever press it must be noted that the PCB outside edge (or the fixture edge) to the connector center is smaller than the distance from the throat of the press to the connector center (dimension 'X').
- Adjust the press shut height to 5 mm [.197"]. Additional visual monitoring of a completed assembly is achieved when the recesses are visible and the slot between the cable guide and the connector is evenly shut.

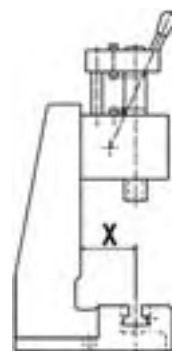

Process

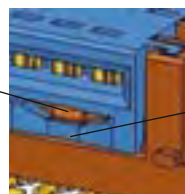

Slot

- Neither the PCB nor the components may be bent during the press-in process.
- The flat cable must be inserted in such a way that it protrudes on the end by 0-1 mm.
- The flat cable must be inserted 90° to the connector.



1.27 mm Connectors SMC

Electrical and Mechanical Characteristics

	Standard	Type B, Type Q and IDC Assemblies	Board-on IDC with AWG30 flat ribbon cable 250 mm																																								
Number of Pins		12, 26, 50, 68, 80	12, 26, 50																																								
Technical Data																																											
Climate category	DIN EN 60068-1 test b	-55/125/56	-55/125/56																																								
Temperature range		-55/125 °C -55/105 °C (IDC Assemblies)	-55/105 °C																																								
Current rating per contact	IEC60512 test 5b	<table border="1"> <thead> <tr> <th></th> <th>20°C</th> <th>70°C</th> <th>100°C</th> </tr> </thead> <tbody> <tr> <td>12pin</td> <td>1.6 A</td> <td>1.1 A</td> <td>0.7 A</td> </tr> <tr> <td>26pin</td> <td>1.3 A</td> <td>0.9 A</td> <td>0.6 A</td> </tr> <tr> <td>50pin</td> <td>1.1 A</td> <td>0.8 A</td> <td>0.5 A</td> </tr> <tr> <td>68pin</td> <td>1.0 A</td> <td>0.8 A</td> <td>0.5 A</td> </tr> <tr> <td>80pin</td> <td>1.0 A</td> <td>0.8 A</td> <td>0.5 A</td> </tr> </tbody> </table>		20°C	70°C	100°C	12pin	1.6 A	1.1 A	0.7 A	26pin	1.3 A	0.9 A	0.6 A	50pin	1.1 A	0.8 A	0.5 A	68pin	1.0 A	0.8 A	0.5 A	80pin	1.0 A	0.8 A	0.5 A	<table border="1"> <thead> <tr> <th></th> <th>20°C</th> <th>70°C</th> <th>100°C</th> </tr> </thead> <tbody> <tr> <td>12pin</td> <td>1.8 A</td> <td>1.1 A</td> <td>0.4 A</td> </tr> <tr> <td>26pin</td> <td>1.6 A</td> <td>1.0 A</td> <td>0.3 A</td> </tr> <tr> <td>50pin</td> <td>1.3 A</td> <td>0.8 A</td> <td>0.3 A</td> </tr> </tbody> </table>		20°C	70°C	100°C	12pin	1.8 A	1.1 A	0.4 A	26pin	1.6 A	1.0 A	0.3 A	50pin	1.3 A	0.8 A	0.3 A
	20°C	70°C	100°C																																								
12pin	1.6 A	1.1 A	0.7 A																																								
26pin	1.3 A	0.9 A	0.6 A																																								
50pin	1.1 A	0.8 A	0.5 A																																								
68pin	1.0 A	0.8 A	0.5 A																																								
80pin	1.0 A	0.8 A	0.5 A																																								
	20°C	70°C	100°C																																								
12pin	1.8 A	1.1 A	0.4 A																																								
26pin	1.6 A	1.0 A	0.3 A																																								
50pin	1.3 A	0.8 A	0.3 A																																								
Air – and creepage distance		0.4 mm	0.4 mm																																								
Operating voltage	IEC 60664	<p>The permissible operating voltages depend on the customer application and on the applicable or specified safety requirements. Insulation coordination according to IEC 60664-1 has to be regarded for the complete electrical device. Therefore, the maximum creepage and clearance distances of the mated connectors are specified for consideration as a part of the whole current path.</p> <p>In practice, reductions in creepage or clearance distances may occur due to the conductive pattern of the printed board or the wiring used, and have to be taken into account separately.</p> <p>As a result the creepage and clearance distances for the application may be reduced compared to those of the connector.</p>																																									
Dielectric strength	IEC 60512 test 4a	contact – contact 500 V _{rms}	contact – contact 500 V _{rms}																																								
Contact resistance	IEC 60512 test 2a	< 25 mΩ < 10 mΩ (IDC clamp)	< 10 mΩ (IDC clamp)																																								
Insulation resistance	IEC 60512 test 3a	> 10 ⁴ MΩ	> 10 ⁴ MΩ																																								
Vibration, sine	IEC 60512 test 6d	10 – 2000 Hz 20g	10 – 2000 Hz 20g																																								
Contact disturbance (while vibration test)	IEC 60512 test 2e	< 1 μs	< 1 μs																																								
Shock, halfsine	IEC 60512 test 6c	50 g 11 ms	50 g 11 ms																																								
Contact disturbance (while shock test)	IEC 60512 test 2e	< 1 μs	< 1 μs																																								
Mechanical operation (mating cycles)	IEC 60512 test 9a	> 500 mating cycles	-																																								
Insertion and withdrawal force	IEC 60512 test 13b	12pin: 6 N 68pin: 35 N 26pin: 13 N 80pin: 40 N 50pin: 26 N	-																																								
Gauge retention force	IEC 60512 test 16e	0.1 N min.	-																																								

1.27 mm Connectors SMC

Electrical and Mechanical Characteristics

	Standard	Type B, Type Q and IDC Assemblies	Board-on with AWG30 flat ribbon cable 250 mm
Number of Pins		12, 26, 50, 68, 80	12, 26, 50
Process-conditions			
Solder temperature max.	IEC 68-2-20		
Hand soldering temperature max.		3.5 s at 350 °C	3.5 s at 350 °C
Dip soldering temperature max.		10 s at 260 °C	10 s at 260 °C
Reflow soldering temperature max.	JEDEC J-STD-020C	20 - 40 s at 260 °C	20 - 40 s at 260 °C
Warning		soldering of pressfit connectors not to be recommended	-
Processing temperature (IDC connection)		0/55 °C	0/55 °C
Coplanarity		< 0.1 mm	< 0.1 mm
Housing Materials			
Plastic material		LCP	LCP
CTI value	IEC 112	CTI 175	CTI 175
UL flame rating		UL 94 V-0	UL 94 V-0
UL file		E 83005	E 83005
Contact Materials			
Base material		Cu alloy	Cu alloy
Mating area		min. 1.0 µm PdNi + 0.1 µm Au over 2-3 µm Ni	-
Termination area		4-6 µm Sn (SMT) 0.5-2 µm Sn (pressfit) over 2-3 µm Ni	IDC termination area: 0.5-2 µm Sn over 2-3 µm Ni SMT termination area: 4-6 µm Sn over 2-3 µm Ni
Clip Materials			
Base material		Cu alloy	Cu alloy
Plating		4-6 µm Sn over 2-3 µm Ni	4-6 µm Sn over 2-3 µm Ni
Environment compatibility			
Recycling		no flame-retardent additives, no toxic additives allows easy recycling	
Product-approval			
UL		E 84703	E 84703

1.27 mm Connectors SMC

Electrical and Mechanical Characteristics

	Standard	Cable (PVC) for Cable Assemblies
Number of Pins		12, 26, 50, 68, 80
Cable Assembly		
Cross section		AWG30 / 7 / 0.06 mm ²
Conductor		Cu wire tin-plated
Marking	DIN 57207/ VDE 0207	Red
Insulation		PVC
Shore hardness		94 ±3 (Shore A)
Technical Data		
Temperature range		-20/105°C
Current rating		0.8 A at 20°C
Voltage rating		max. 150 V
Dielectric strength		1500 V _{rms}
Conductor resistance		≤ 350 Ω/km
Insulation resistance		≥ 100 MΩ x km at 20°C
Capacitance at 1 kHz		ground-signal-ground 60 pF/m
Inductance at 10 kHz		ground-signal-ground 0.5 μH/m
Impedance		ground-signal-ground 75 Ω
Crosstalk		Cable length 3 m: NE 2.6 / FE 3.8
Propagation delay		4.5 ns/m
UL flammability		UL 94 VW-1
Product-approval		
UL style		2678
CSA specification		AWM IA 105°, 150 V FT-1

1.27 mm Connectors SMC

Right Angle Male Type B



Dimensional Drawings

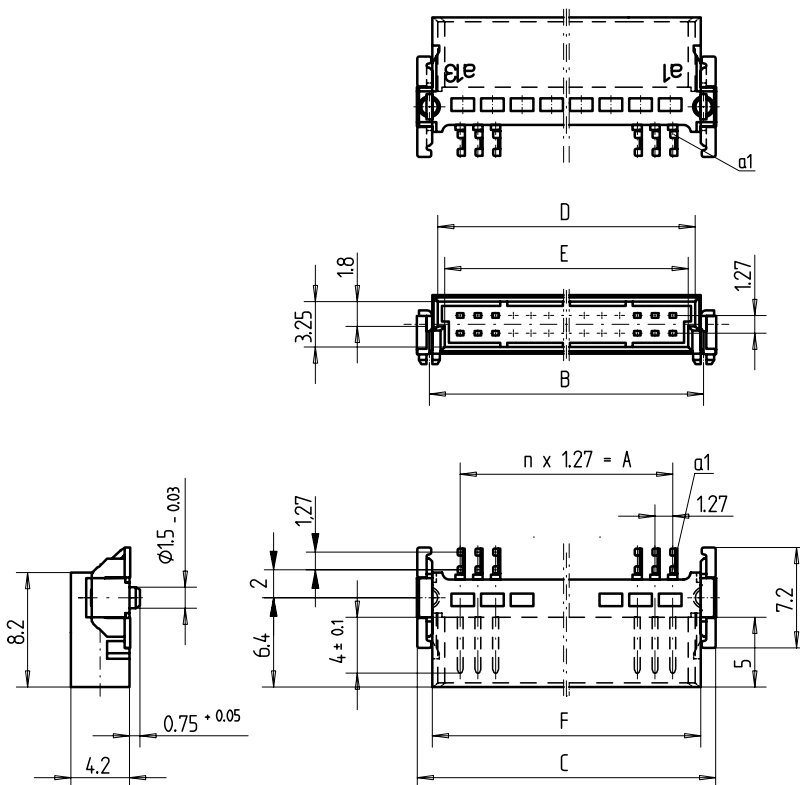

12	6.35	10.77	12.7	9.57	8.57	10.35
26	15.24	19.66	21.6	18.46	17.46	19.24
50	30.48	34.9	36.8	33.7	32.7	34.48
68	41.91	46.33	48.2	45.13	44.13	45.91
80	49.53	53.95	55.8	52.75	51.75	53.53
Polzahl No. of contacts	A	B	C	D	E	F

Leiterplatten-Layout Vorschlag für SMT PCB-Layout Proposal for SMT

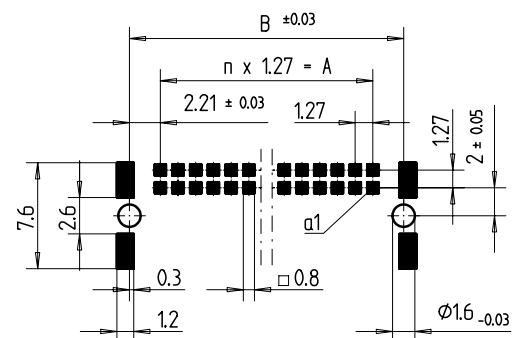





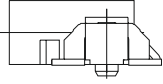
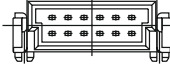
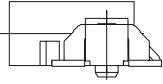
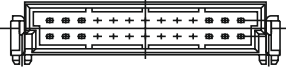
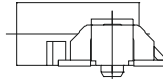

All dimensions in mm.

1.27 mm Connectors SMC

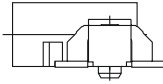
Right Angle Male Type B

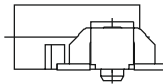
Ordering Information

Configuration	No. of Pins	Termination	Packaging	Part Number
				
Type B	12	SMT	Tape and reel/560 pcs	054594
				
Type B	26	SMT	Tape and reel/560 pcs	054595
				
Type B	50	SMT	Tape and reel/560 pcs	054596
				
Type B	68	SMT	Tape and reel/560 pcs	114805
				
Type B	80	SMT	Tape and reel/560 pcs	114806



1.27 mm Connectors SMC

Right Angle Male Type B with Locking System



Dimensional Drawings

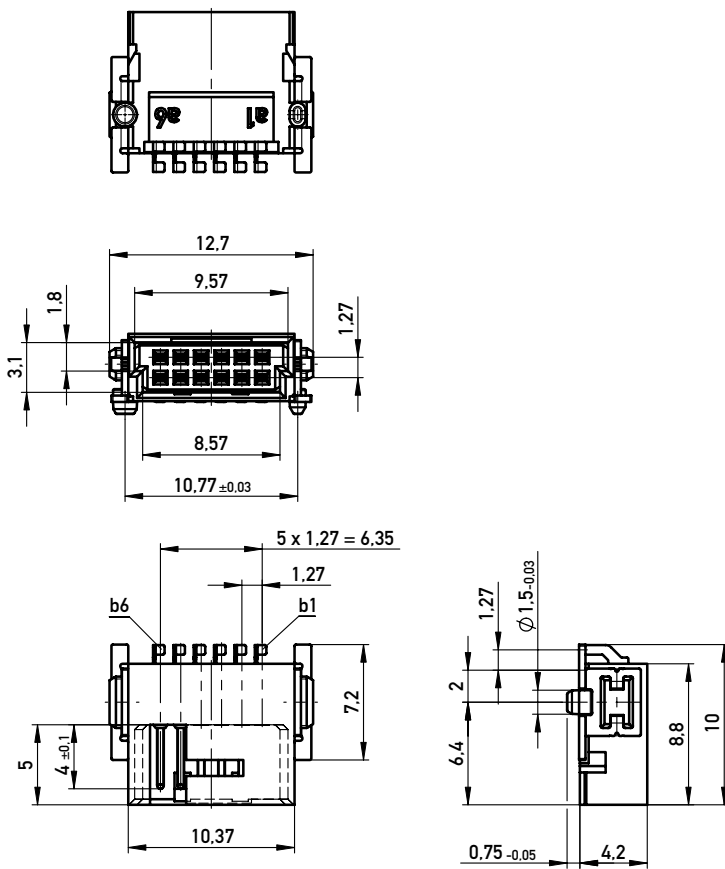

Leiterplatten-Layout Vorschlag für SMT PCB-Layout Proposal for SMT

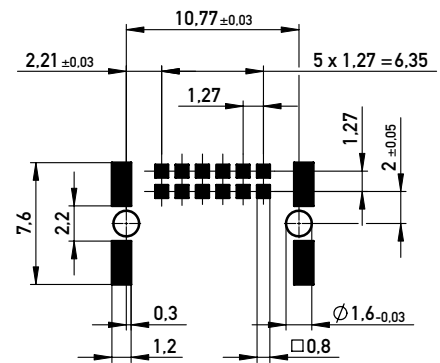



All dimensions in mm.

1.27 mm Connectors SMC

Right Angle Male Type B with Locking System

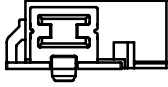
Ordering Information

Configuration	No. of Pins	Termination	Packaging	Part Number
				
Type B	12	SMT	Tape and reel/560 pcs	254273

1.27 mm Connectors SMC

Vertical Male Type Q



Dimensional Drawings

Connectors with Unmated Stacking Height 1.75 mm

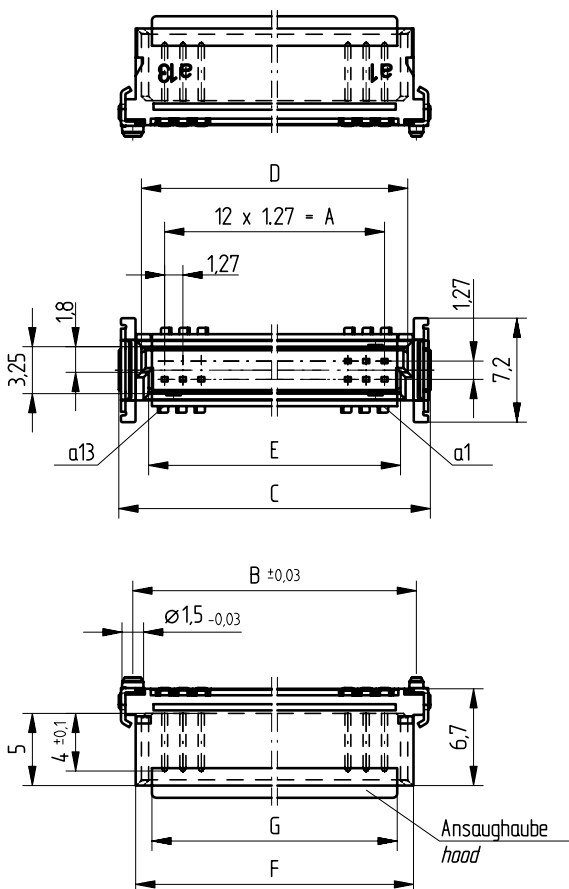

12	6.35	10.77	12.7	9.57	8.57	10.37	5.6
26	15.24	19.66	21.59	18.46	17.46	19.26	17
50	30.48	34.9	36.83	33.7	32.7	34.5	17
68	41.91	46.33	48.26	45.13	44.13	45.93	17
80	49.53	53.95	55.88	52.75	51.75	53.53	17
Polzahl No. of contacts	A	B	C	D	E	F	G

Leiterplatten-Lay-out Vorschlag für SMT PCB-Lay-out Proposal for SMT

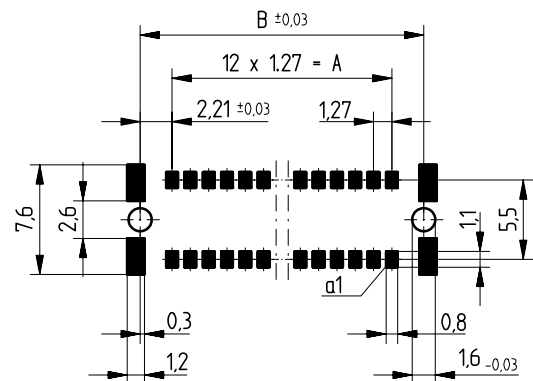

All dimensions in mm.



1.27 mm Connectors SMC

Vertical Male Type Q

Dimensional Drawings

Connectors with Unmated Stacking Height 3.25 mm

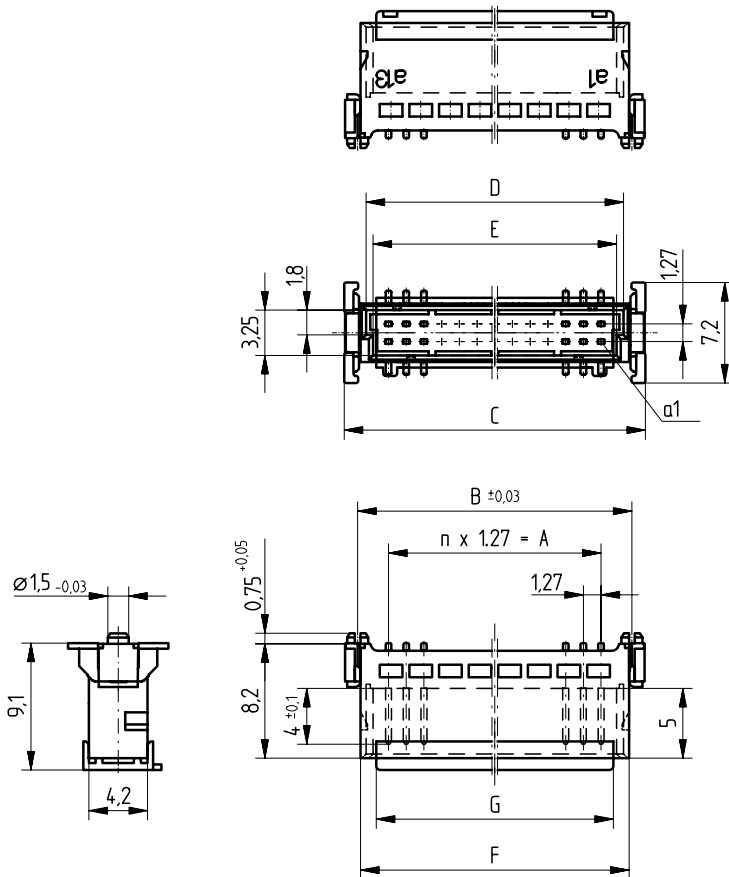

Leiterplatten-Lay-out Vorschlag für SMT
PCB-Lay-out Proposal for SMT

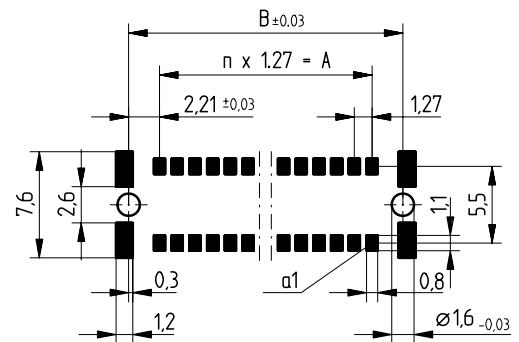

12	6.35	10.77	12.7	9.57	8.57	10.35	5.6
26	15.24	19.66	21.6	18.46	17.46	19.24	17
50	30.48	34.9	36.8	33.7	32.7	34.48	17
68	41.91	46.33	48.2	45.13	44.13	45.91	17
80	49.53	53.95	55.8	52.75	51.75	53.53	17
Polzahl No. of contacts	A	B	C	D	E	F	G

All dimensions in mm.

1.27 mm Connectors SMC

Vertical Male Type Q

Ordering Information

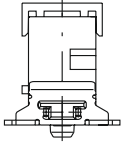
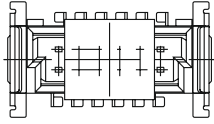
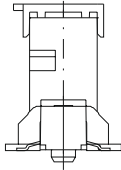
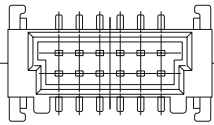
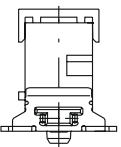
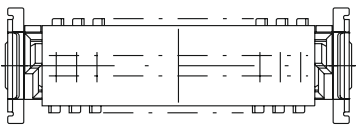
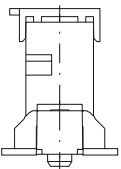
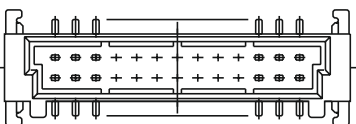
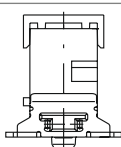
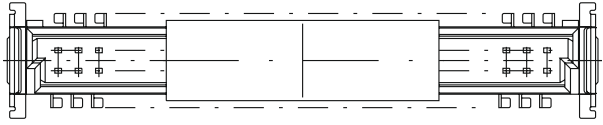
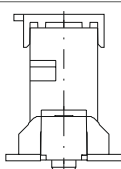
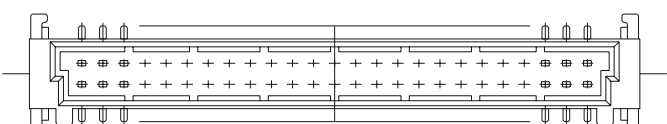
Configuration	No. of Pins	Termination	Unmated Stacking Height	Packaging	Part Number
					
Type Q	12	SMT	1.75 mm	Tape and reel/280 pcs	154818
					
Type Q	12	SMT	3.25 mm	Tape and reel/280 pcs	063179
					
Type Q	26	SMT	1.75 mm	Tape and reel/280 pcs	154819
					
Type Q	26	SMT	3.25 mm	Tape and reel/280 pcs	063209
					
Type Q	50	SMT	1.75 mm	Tape and reel/280 pcs	154820
					
Type Q	50	SMT	3.25 mm	Tape and reel/280 pcs	063210



1.27 mm Connectors SMC

Vertical Male Type Q

Ordering Information

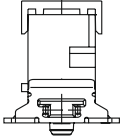
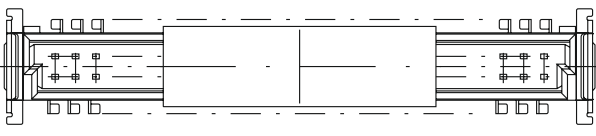
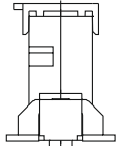
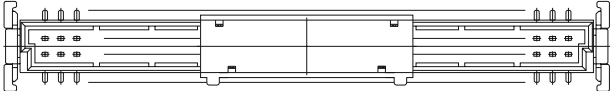
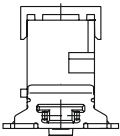
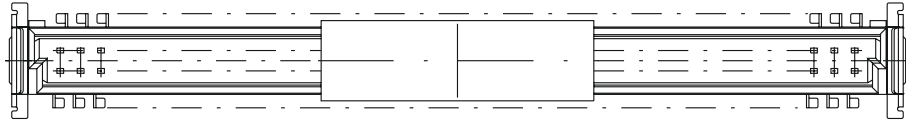
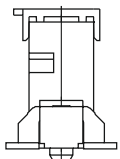
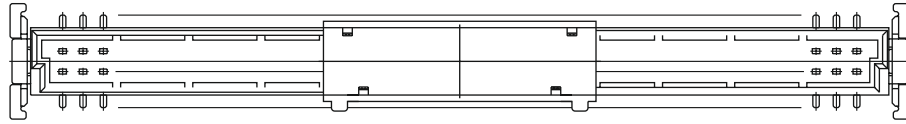
Configuration	No. of Pins	Termination	Unmated Stacking Height	Packaging	Part Number
					
Type Q	68	SMT	1.75 mm	Tape and reel/280 pcs	154821
					
Type Q	68	SMT	3.25 mm	Tape and reel/280 pcs	114807
					
Type Q	80	SMT	1.75 mm	Tape and reel/280 pcs	154822
					
Type Q	80	SMT	3.25 mm	Tape and reel/280 pcs	114808



1.27 mm Connectors SMC

Vertical Male Pressfit Type Q



Dimensional Drawings

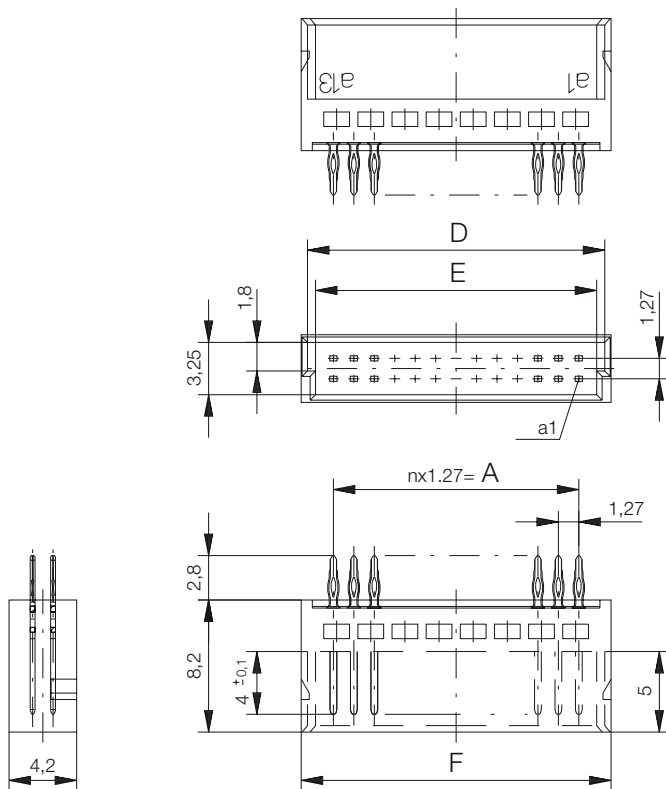

Lochbild für Leiterplatte
Board hole pattern

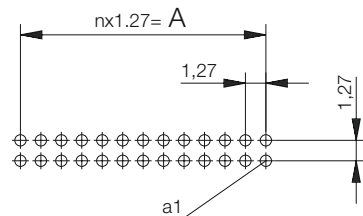





12	6.35	9.57	8.57	10.35
26	15.24	18.46	17.46	19.24
50	30.48	33.7	32.7	34.48
68	41.91	45.13	44.13	45.91
80	49.53	52.75	51.75	53.53
Polzahl No. of contacts	A	D	E	F

All dimensions in mm.

1.27 mm Connectors SMC

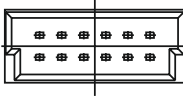
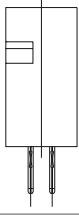
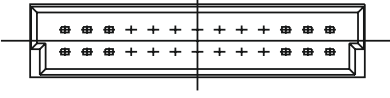
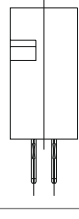
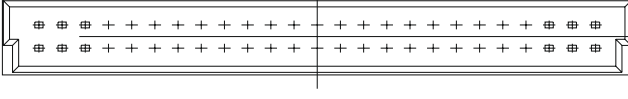
Vertical Male Pressfit Type Q

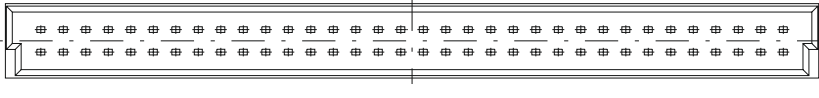
Ordering Information

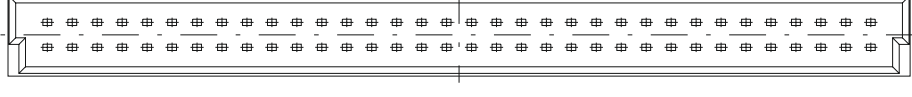
Configuration	No. of Pins	Termination	Unmated Stacking Height	Packaging	Part Number
					
Type Q	12	Pressfit	3.25 mm	Tube/65 pcs	064002
					
Type Q	26	Pressfit	3.25 mm	Tube/35 pcs	064003
					
Type Q	50	Pressfit	3.25 mm	Tube/19 pcs	064004
					
Type Q	68	Pressfit	3.25 mm	Tube/14 pcs	144183
					
Type Q	80	Pressfit	3.25 mm	Tube/12 pcs	144185



1.27 mm Connectors SMC

Right Angle Female Type Q



Dimensional Drawings

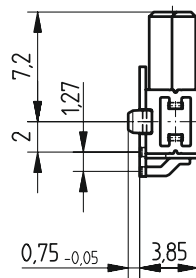
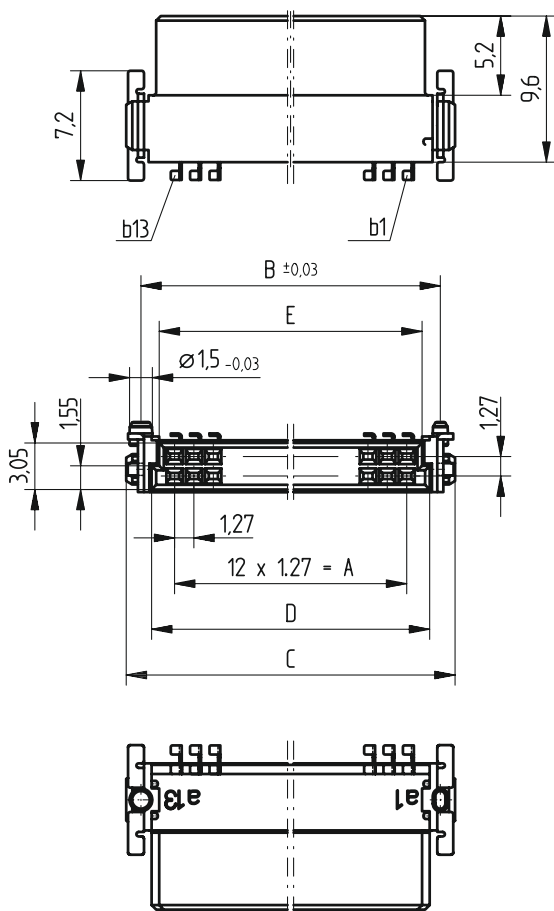

12	6.35	10.77	12.7	9.37	8.37
26	15.24	19.66	21.59	18.26	17.26
50	30.48	34.9	36.83	33.5	32.5
68	41.91	46.33	48.26	44.93	43.93
80	49.53	53.95	55.88	52.55	51.55
Polzahl No. of contacts	A	B	C	D	E

Leiterplatten-LAYOUT Vorschlag für SMT PCB-Layout Proposal for SMT

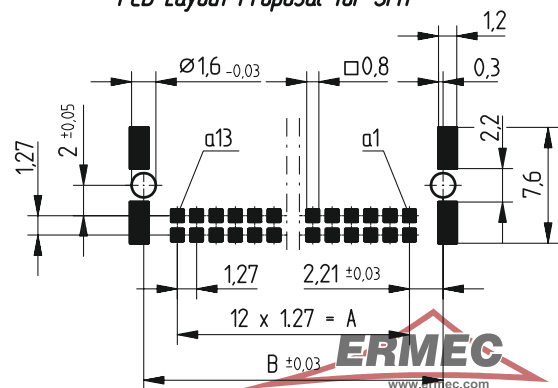







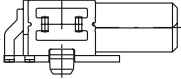

All dimensions in mm.

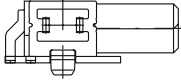
1.27 mm Connectors SMC

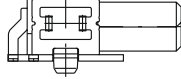
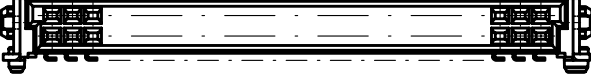
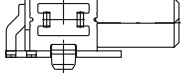
Right Angle Female Type Q

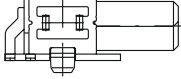
Ordering Information



Configuration	No. of Pins	Termination	Packaging	Part Number
				
Type Q	12	SMT	Tape and reel/560 pcs	154740
				
Type Q	26	SMT	Tape and reel/560 pcs	154741
				
Type Q	50	SMT	Tape and reel/560 pcs	154742
				
Type Q	68	SMT	Tape and reel/560 pcs	154743
				
Type Q	80	SMT	Tape and reel/560 pcs	154744



1.27 mm Connectors SMC

Right Angle Female Type Q with Locking System

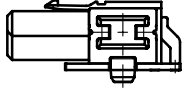
Ordering Information

Configuration	No. of Pins	Termination	Packaging	Part Number
				
Type Q	12	SMT	Tape and reel/560 pcs	254262

1.27 mm Connectors SMC

Vertical Female Type B



Dimensional Drawings

Connectors with Unmated Stacking Height 6.25 mm

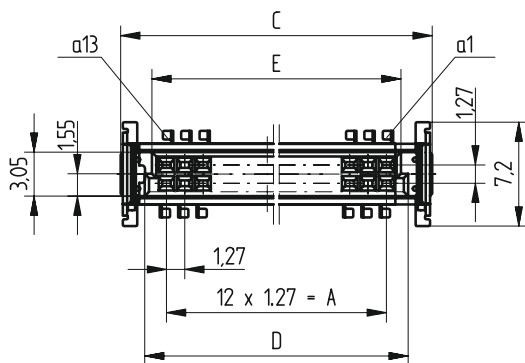
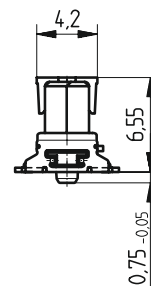
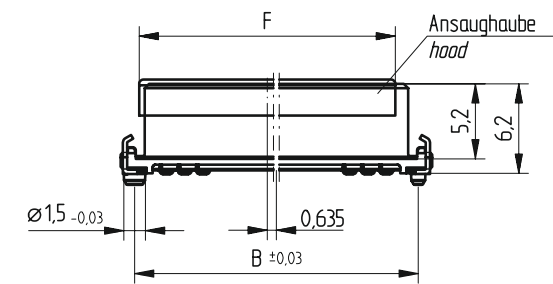

12	6.35	10.77	12.7	9.37	8.37	7.6
26	15.24	19.66	21.59	18.26	17.26	17.76
50	30.48	34.9	36.83	33.5	32.5	17.76
68	41.91	46.33	48.26	44.93	43.93	17.76
80	49.53	53.95	55.88	52.55	51.55	17.76
Polzahl No. of contacts	A	B	C	D	E	F

Leiterplatten-Lay-out Vorschlag für SMT
PCB-Lay-out Proposal for SMT

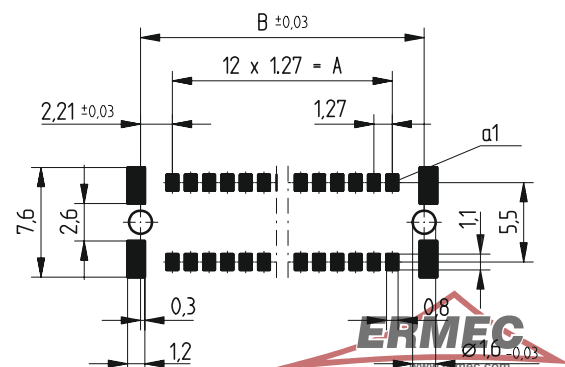

All dimensions in mm.

1.27 mm Connectors SMC

Vertical Female Type B

Dimensional Drawings

Connectors with Unmated Stacking Height 9.05 mm

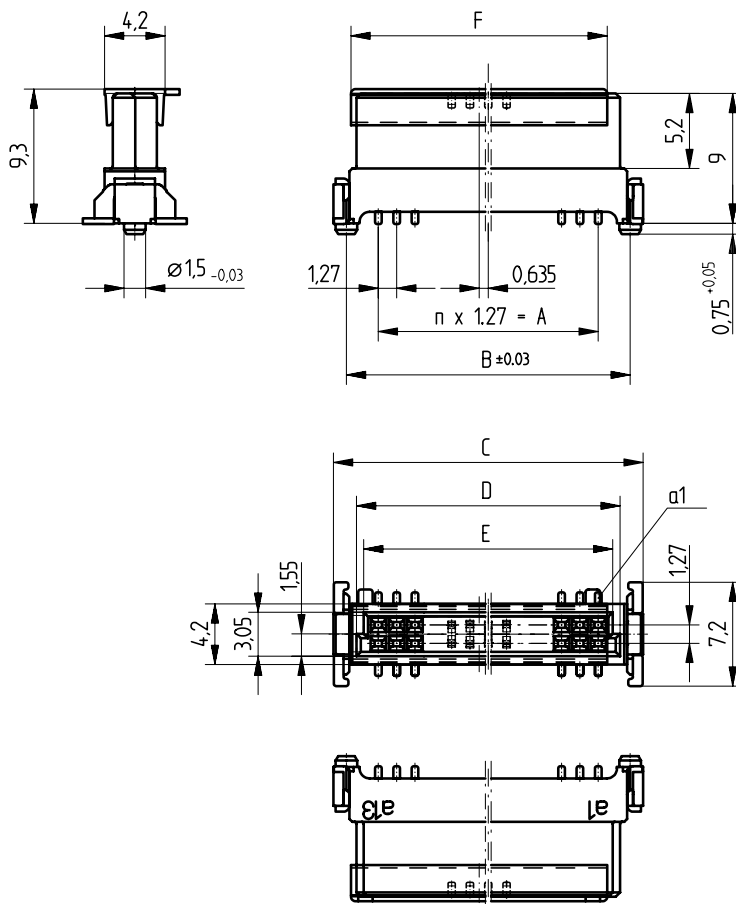

12	6.35	10.77	12.7	9.37	8.37	7.6
26	15.24	19.66	21.6	18.26	17.26	17.76
50	30.48	34.9	36.8	33.5	32.5	17.76
68	41.91	46.33	48.2	44.93	43.93	17.76
80	49.53	53.95	55.8	52.55	51.55	17.76
Polzahl No. of contacts	A	B	C	D	E	F

Leiterplatten-Layout Vorschlag für SMT
PCB-Layout Proposal for SMT

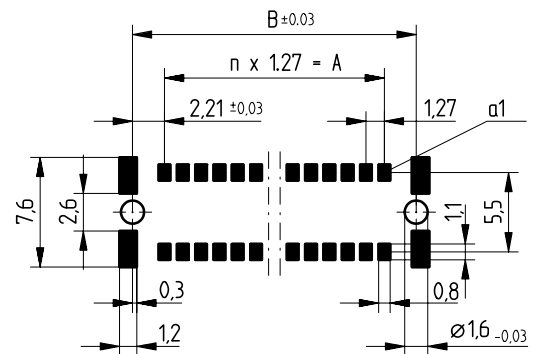

All dimensions in mm.

1.27 mm Connectors SMC

Vertical Female Type B

Dimensional Drawings

Connectors with Unmated Stacking Height 13.65 mm

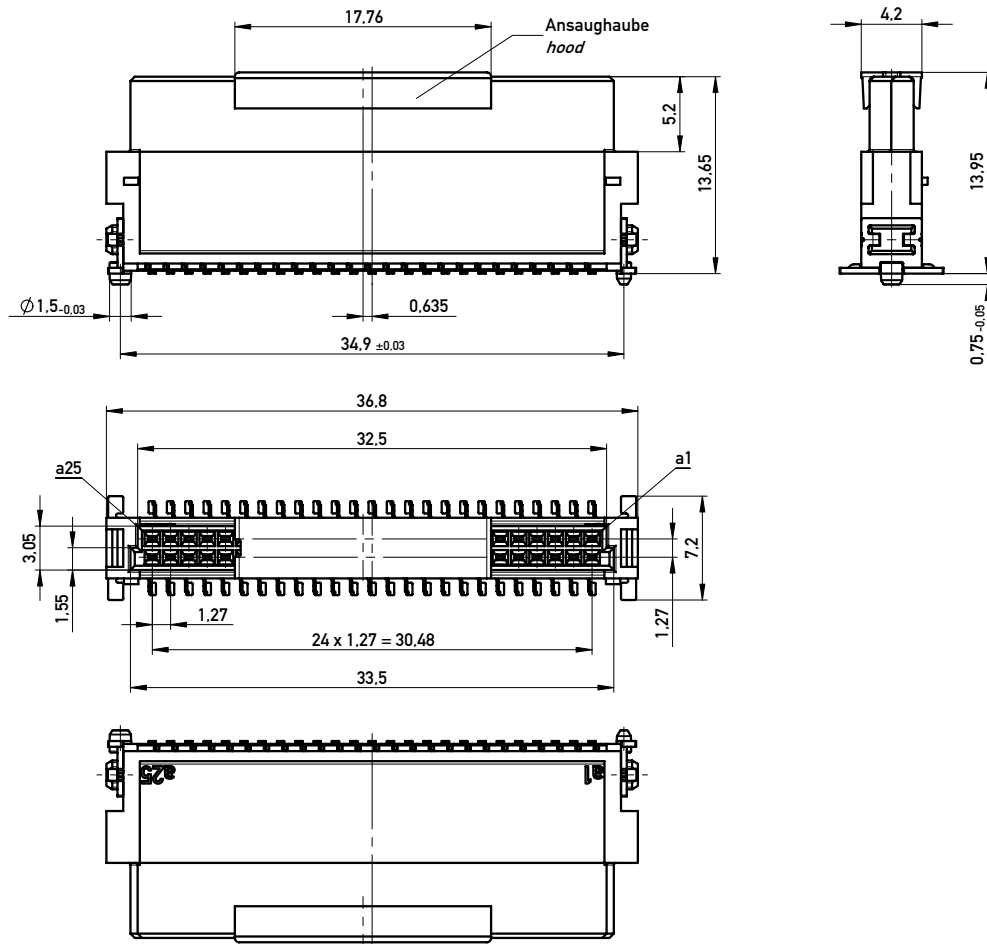

Leiterplatten-Layout Vorschlag für SMT PCB-Layout Proposal for SMT

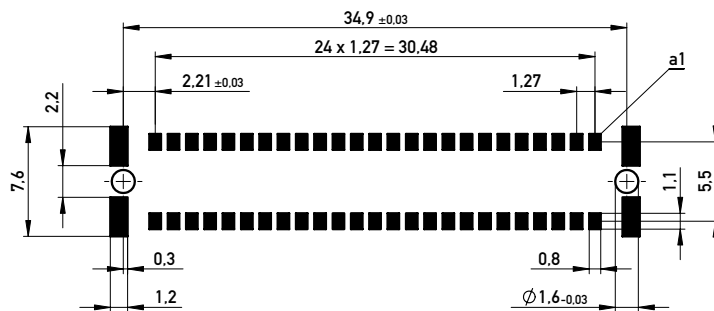

All dimensions in mm.

1.27 mm Connectors SMC

Vertical Female Type B

Ordering Information

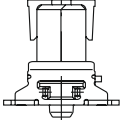
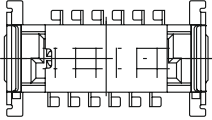
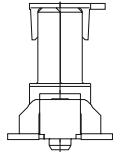
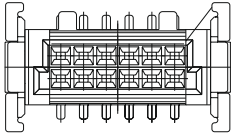
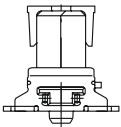
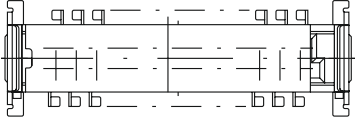
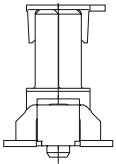
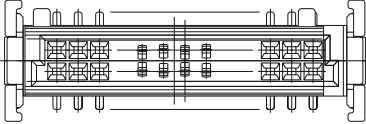
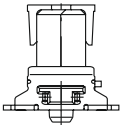
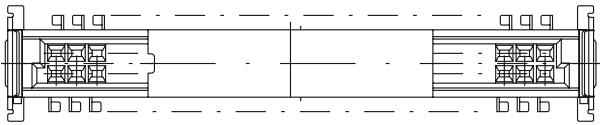
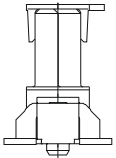
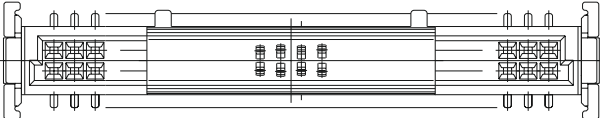
Configuration	No. of Pins	Termination	Unmated Stacking Height	Packaging	Part Number
					
Type B	12	SMT	6.25 mm	Tape and reel/280 pcs	154805
					
Type B	12	SMT	9.05 mm	Tape and reel/280 pcs	124043
					
Type B	26	SMT	6.25 mm	Tape and reel/280 pcs	154806
					
Type B	26	SMT	9.05 mm	Tape and reel/280 pcs	124044
					
Type B	50	SMT	6.25 mm	Tape and reel/280 pcs	154807
					
Type B	50	SMT	9.05 mm	Tape and reel/280 pcs	124045



1.27 mm Connectors SMC

Vertical Female Type B

Ordering Information

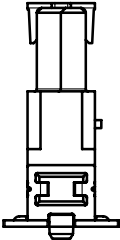
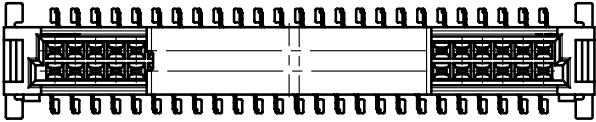
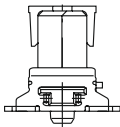
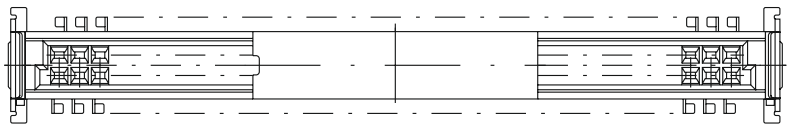
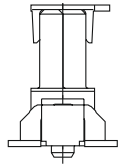
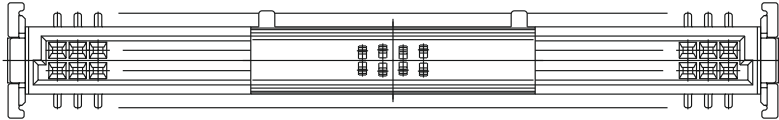
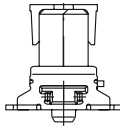
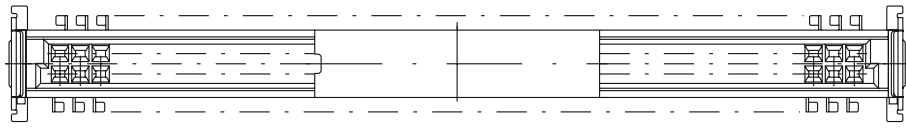
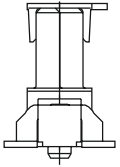
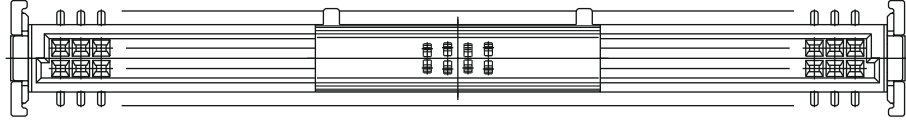
Configuration	No. of Pins	Termination	Unmated Stacking Height	Packaging	Part Number
					
Type B	50	SMT	13.65 mm	Tape and reel/170 pcs	234199
					
Type B	68	SMT	6.25 mm	Tape and reel/280 pcs	154808
					
Type B	68	SMT	9.05 mm	Tape and reel/280 pcs	114803
					
Type B	80	SMT	6.25 mm	Tape and reel/280 pcs	154809
					
Type B	80	SMT	9.05 mm	Tape and reel/280 pcs	114804





Dimensional Drawings

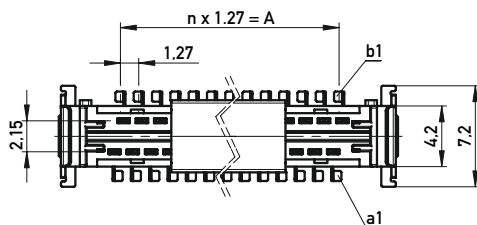
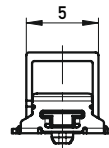
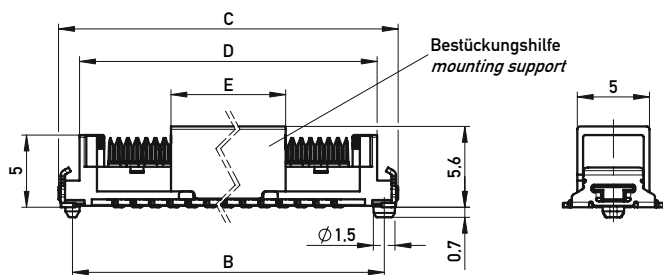

12	6.35	12.77	14.7	11.785	8	11
26	15.24	21.66	23.59	20.675	8	20
50	30.48	36.9	38.83	35.915	8	35
Pohlzahl No. of contacts	A	B	C	D	E	L

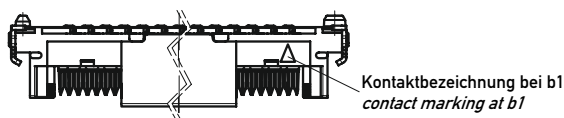

Leiterplatten-Layout Vorschlag für SMT
PCB-Layout Proposal for SMT

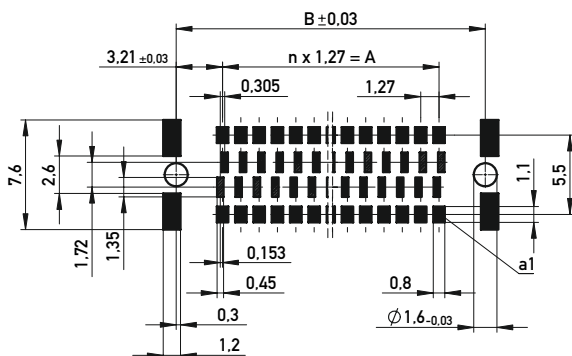

■ Sperrfläche
Restricted area

Leiterplatten-Layout Rückseite
PCB-Layout Back Side

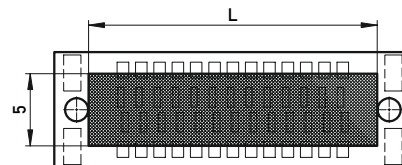

Freifläche Lx 5mm auf der Leiterplatten-Unterseite für das Einpresswerkzeug. Keine Bauteile platzieren in diesem Bereich.
PCB back side space Lx5mm for press tool. Do not place any parts in this space.

All dimensions in mm.



1.27 mm Connectors SMC

Board-on IDC

Dimensional Drawings

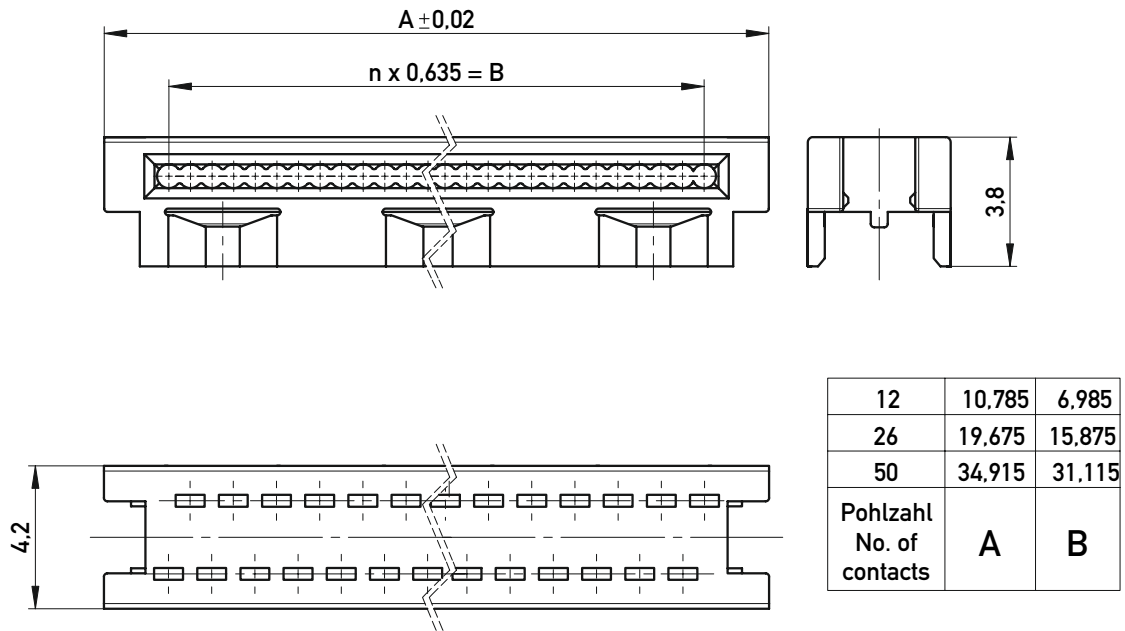



All dimensions in mm.

1.27 mm Connectors SMC

Board-on IDC

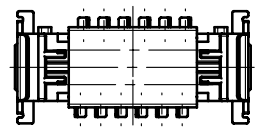
Ordering Information

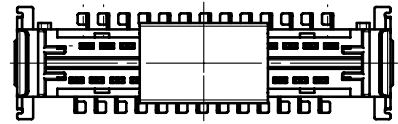
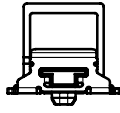
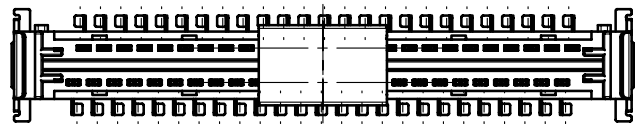
Configuration	No. of Pins	Termination	Packaging	Part Number
				
Board-on IDC	12	SMT/IDC	Tape and reel/280 pcs	244628
Cable guide for 12 pin Board-on connector	–	–	Poly bag/280 pcs	244631
				
Board-on IDC	26	SMT/IDC	Tape and reel/280 pcs	244629
Cable guide for 26 pin Board-on connector	–	–	Poly bag/280 pcs	244632
				
Board-on IDC	50	SMT/IDC	Tape and reel/280 pcs	244630
Cable guide for 50 pin Board-on connector	–	–	Poly bag/280 pcs	244633



1.27 mm Connectors SMC

Female Cable Assemblies



Dimensional Drawings

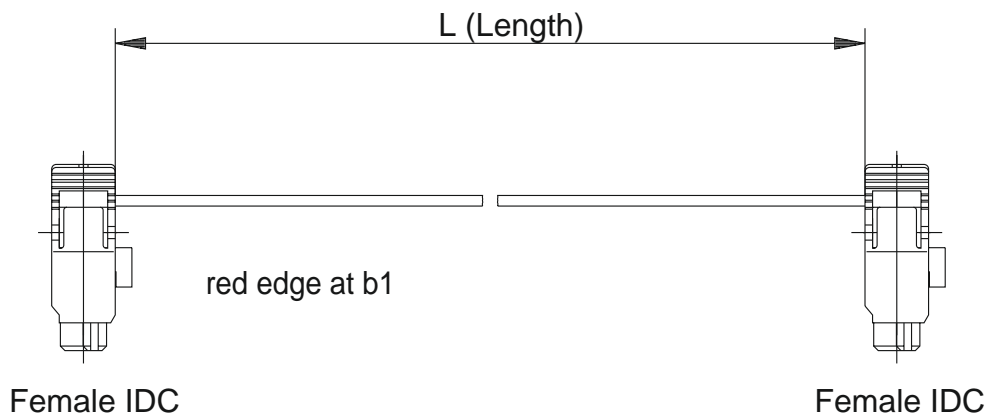

1.27 mm Connectors SMC

Female Cable Assemblies

Ordering Information

No. of Pins	Length	Cable Size	Cable Type	Part Number
12	100 mm	AWG 30	PVC	173799
12	200 mm	AWG 30	PVC	173800
12	300 mm	AWG 30	PVC	173801
26	100 mm	AWG 30	PVC	173796
26	200 mm	AWG 30	PVC	173797
26	300 mm	AWG 30	PVC	173798
50	100 mm	AWG 30	PVC	173793
50	200 mm	AWG 30	PVC	173794
50	300 mm	AWG 30	PVC	173795
68	100 mm	AWG 30	PVC	193888
68	200 mm	AWG 30	PVC	193889
68	300 mm	AWG 30	PVC	193890
80	100 mm	AWG 30	PVC	193891
80	200 mm	AWG 30	PVC	193892
80	300 mm	AWG 30	PVC	193893



1.27 mm Connectors SMC

Part Number Index

Part Number	Page	Part Number	Page
054594	15	193892	37
054595	15	193893	37
054596	15	220160	9
063179	20	220162	9
063209	20	220164	9
063210	20	220165	9
064002	23	220167	9
064003	23	220169	9
064004	23	220644	9
114803	32	220645	9
114804	32	220646	9
114805	15	220647	9
114806	15	234199	32
114807	21	244628	35
114808	21	244629	35
124043	31	244630	35
124044	31	244631	35
124045	31	244632	35
144183	23	244633	35
144185	23	254262	27
154740	25	254273	17
154741	25		
154742	25		
154743	25		
154744	25		
154805	31		
154806	31		
154807	31		
154808	32		
154809	32		
154818	20		
154819	20		
154820	20		
154821	21		
154822	21		
173793	37		
173794	37		
173795	37		
173796	37		
173797	37		
173798	37		
173799	37		
173800	37		
173801	37		
193888	37		
193889	37		
193890	37		
193891	37		





Member



VMEbus INTERNATIONAL TRADE ASSOCIATION



ERMEC, S.L. BARCELONA
C/ Francesc Teixidó, 22
E-08918 Badalona
(Spain)



Tel.: (+34) 902 450 160
Fax: (+34) 902 433 088
info@ermec.com
www.ermec.com

ERMEC, S.L. MADRID
C/ Sagasta, 8, 1ª planta
E-28004 Madrid
(Spain)

PORTUGAL
portugal@ermec.com
BILBAO
bilbao@ermec.com

www.erni.com



ERMEC, S.L. BARCELONA C/ Francesc Teixidó, 22 E-08918 Badalona (Spain)	 www.ermec.com Distribución de componentes eléctricos y electrónicos	Tel.: (+34) 902 450 160 Fax: (+34) 902 433 088 info@ermec.com www.ermec.com	ERMEC, S.L. MADRID C/ Sagasta, 8, 1ª planta E-28004 Madrid (Spain)	PORTUGAL portugal@ermec.com BILBAO bilbao@ermec.com
--	---	---	--	--

ERNI Electronics GmbH

Seestrasse 9
73099 Adelberg, Deutschland
Tel +49 (0)71 66 50-0
Fax +49 (0)71 66 50-282
info@erni.de

Europe South America Africa Japan

ERNI Electronics, Inc.

3005 E. Boundary Terrace
Midlothian, VA 23112
Tel +1 (804) 228-4100
Fax +1 (804) 228-4099
info.usa@erni.com

North America Canada Mexico

ERNI Asia Holding Pte Ltd.

Blk 4008 Ang Mo Kio Avenue 10
#04-01/02 Techplace I
Singapore 569625
Tel +65 6 555 5885
Fax +65 6 555 5995
info@erni-asia.com

Asia

www.erni.com

© ERNI Electronics GmbH 2008 • Printed in Germany. A policy of continuous improvement is followed and the right to alter any published data without notice is reserved.
ERNI®, MicroStac®, MicroSpeed®, MiniBridge®, MaxiBridge®, ERmet®, ERmet ZD®, ERbic® and ERNIPRESS® are trademarks (registered or applied for in various countries) of ERNI Electronics GmbH.