

6300

VALVULA
DE BOLA EN
MINIATURA
(H – H)



ROSCA	ROSCA	P.V.P
1/8	1/8	4,84 €
1/4	1/4	5,03 €
3/8	3/8	5,27 €
1/2	1/2	7,23 €
3/4	3/4	9,47 €

6560

VALVULA
DE BOLA EN
MINIATURA
(TUBO – TUBO)



TUBO	TUBO	P.V.P
4	4	7,23 €
6	6	7,65 €
8	8	8,03 €

6065 - INOX

VALVULA
DE BOLA EN
MINIATURA
(H-H)



ROSCA	P.V.P
1/4	21,42 €
3/8	23,16 €
1/2	25,41 €
3/4	32,21 €
1"	43,18 €

6310

VALVULA
DE BOLA EN
MINIATURA
(M – H)



ROSCA	ROSCA	P.V.P
1/8	1/8	4,84 €
1/4	1/8	4,87 €
1/4	1/4	5,03 €
3/8	1/4	0,00 €
3/8	3/8	5,22 €
1/2	1/2	7,18 €
3/4	3/4	9,37 €

6600

VALVULA
DE BOLA EN
MINIATURA
(H-H) ESCAPE ATMOSFERA



ROSCA	ROSCA	P.V.P
1/8	1/8	7,09 €
1/4	1/4	7,12 €
3/8	3/8	7,71 €

6066 - INOX

VALVULA
DE BOLA EN
MINIATURA
(M-H)



ROSCA	P.V.P
1/4	21,42 €
3/8	23,16 €
1/2	25,41 €
3/4	32,21 €
1"	43,18 €

6065

VALVULA
DE BOLA EN
MINIATURA
(H-H)



ROSCA	ROSCA	P.V.P
1/8	1/8	3,84 €
1/4	1/4	3,39 €
3/8	3/8	3,39 €
1/2	1/2	3,75 €
3/4	3/4	6,16 €

6420

VALVULA
DE BOLA EN
MINIATURA
(M – M)



ROSCA	ROSCA	P.V.P
1/8	1/8	4,81 €
1/8	1/4	4,81 €
1/4	1/4	4,81 €
3/8	1/4	4,81 €
3/8	3/8	5,01 €
1/2	3/8	5,08 €
1/2	1/2	6,69 €
3/4	1/2	6,88 €
3/4	3/4	8,81 €

6066

VALVULA
DE BOLA EN
MINIATURA
(M-H)



ROSCA	ROSCA	P.V.P
1/8	1/8	3,84 €
1/4	1/4	3,39 €
3/8	3/8	3,39 €
1/2	1/2	3,75 €
3/4	3/4	6,16 €

63029

VALVULA
DE BOLA
PASO TOTAL
(H – H) PN-25



ROSCA	P.V.P
1/2	3,74 €
3/4	5,07 €
1	7,87 €
1"1/4"	13,93 €
1"1/2"	19,00 €
2"	25,54 €
2"1/2"	62,33 €
3"	89,67 €
4"	133,42 €

63030

VALVULA
DE BOLA
PASO TOTAL
(H - H) PN-30



ROSCA	P.V.P
1/4	4,03 €
3/8	4,03 €
1/2	4,03 €
3/4	6,01 €
1"	8,44 €
1"1/4"	15,19 €
1"1/2"	20,40 €
2"	33,14 €
2"1/2"	63,14 €
3"	103,85 €
4"	158,69 €

63035

VALVULA
ESFERA
PALOMILLA
(H - H)



ROSCA	P.V.P
1/4	4,43 €
3/8	3,96 €
1/2	3,74 €
3/4	5,07 €
1"	7,87 €

6050

VALVULA
DE ESCAPE
RAPIDO



ROSCA	P.V.P
M5	4,74 €
1/8	5,86 €
1/4	7,20 €
3/8	8,49 €
1/2	12,17 €
3/4	16,68 €
1"	135,01 €

63033

VALVULA
DE BOLA
PASO TOTAL CON
PURGA (H-H) PN-25



ROSCA	P.V.P
1/2	6,00 €
3/4	9,41 €
1"	12,62 €
1"1/4"	19,36 €
1"1/2"	29,72 €

63036

VALVULA
ESFERA
PALOMILLA
(M - H)



ROSCA	P.V.P
1/4	4,56 €
3/8	4,29 €
1/2	3,86 €
3/4	5,27 €
1"	8,50 €

6060

VALVULA
DE PASO
3 VIAS



ROSCA	ROSCA	P.V.P
M5	M5	9,21 €
1/8	1/8	8,88 €
1/4	1/4	11,02 €
3/8	3/8	13,49 €
1/2	1/2	16,99 €

62012 - INOX

VALVULA
DE BOLA
PASO TOTAL
(H - H)



ROSCA	P.V.P
1/4	17,86 €
3/8	17,86 €
1/2	17,86 €
3/4	25,91 €
1"	36,41 €
1"1/4"	54,05 €
1"1/2"	72,35 €
2"	106,72 €
2" 1/2"	283,65 €
3"	392,93 €

63059

VALVULA
DE BOLA
CON MANETA
PARA MANGUERA



ROSCA	P.V.P
1/2 X 3/4	3,72 €
3/4 X 1"	4,84 €
1" X 1"	10,25 €

6062

ANTIRRETORNO
(H - H)



ROSCA	ROSCA	P.V.P
M5	M5	5,24 €
1/8	1/8	4,98 €
1/4	1/4	6,15 €
3/8	3/8	13,38 €
1/2	1/2	13,76 €

62012 - INOX

VALVULA
DE BOLA
PASO TOTAL
(H - H)



ROSCA	P.V.P
1/4	17,86 €
3/8	17,86 €
1/2	17,86 €
3/4	25,91 €
1"	36,41 €
1"1/4"	54,05 €
1"1/2"	72,35 €
2"	106,72 €
2" 1/2"	283,65 €
3"	392,93 €

31000

VÁLVULA
ESFERA
TUBO-TUBO



TUBO	P.V.P
20	10,02 €
25	15,01 €
32	22,55 €

6062 - INOX

ANTIRRETORNO
(H - H)



ROSCA	ROSCA	P.V.P
1/8	1/8	55,47 €
1/4	1/4	61,06 €
3/8	3/8	63,97 €
1/2	1/2	84,32 €
3/4	3/4	147,57 €
1"	1"	193,36 €

6063
ANTIRRETORNO
(M – H)



ROSCA	ROSCA	P.V.P
M5	M5	5,48 €
1/8	1/8	5,24 €
1/4	1/4	6,43 €
3/8	3/8	14,07 €
1/2	1/2	14,43 €

6064
ANTIRRETORNO
AUTOMATICO



TUBO	P.V.P
4	6,16 €
6	6,47 €
8	6,98 €

6035
FILTRO “Y”
LATON



ROSCA	P.V.P
1/4	7,23 €
3/8	7,25 €
1/2	6,59 €
3/4	6,90 €
1”	12,69 €
1”1/4	26,26 €
1”1/2	28,71 €
2”	48,39 €
2” 1/2	121,91 €
3”	176,08 €
4”	346,85 €

6035 - INOX
FILTRO “Y”
LATON



ROSCA	P.V.P
1/4	18,63 €
3/8	18,63 €
1/2	18,63 €
3/4	27,03 €
1”	38,21 €
1”1/4	64,80 €
1”1/2	87,16 €
2”	129,15 €

6036
VALVULA DE
RETENCION
YORK



ROSCA	P.V.P
3/8	5,16 €
1/2	3,80 €
3/4	7,68 €
1”	10,47 €
1”1/4	13,81 €
1”1/2	18,14 €
2”	28,23 €
2” 1/2	47,76 €
3”	88,57 €
4”	139,06 €

6038
FILTRO
VALVULA
YORK



ROSCA	P.V.P
3/8	1,15 €
1/2	0,68 €
3/4	0,84 €
1”	1,28 €
1”1/4	1,44 €
1”1/2	1,69 €
2”	2,55 €
2” 1/2	3,50 €
3”	4,31 €
4”	5,69 €

6724
GRIFO DE
PURGA



ROSCA	P.V.P
1/8	1,83 €
1/4	1,67 €
3/8	1,87 €
1/2	4,35 €

6725
GRIFO DE
PURGA
PALOMETA



ROSCA	P.V.P
1/8	1,84 €
1/4	1,84 €
3/8	1,93 €
1/2	2,35 €

3032 - TL
TAPON
DE NIVEL
DE ACEITE



ROSCA	P.V.P
1/4	2,60 €
3/8	3,02 €
1/2	4,17 €
3/4	4,96 €
1	7,30 €

6723
GRIFO
PUNZON
(M – H)



ROSCA	P.V.P
1/4	5,74 €

NBZ-5
NEBULIZADOR



REF	P.V.P
NBZ-5	41,98 €

PISTOLAS SOPLADORAS

450001/E

PISTOLA DE ALUMINIO



TIPO	P.V.P
450001/E	5,97 €
CON RACORD	6,18 €
CON PROLONG.	7,48 €
PROLONGADOR	4,26 €

460001/P

PISTOLA DE RESINA



TIPO	P.V.P
1/4	25,88 €
CON PROLONG.	27,22 €

321 90

PISTOLA EN MINIATURA



LARGO	UDS	P.V.P
90	10	15,66 €
200	1	17,53 €
290	1	18,57 €

CORTATUBOS

TOTBMW

CORTATUBO DE PLASTICO



REF.	P.V.P
TOTBMW	6,28 €

PT

CORTATUBO METALICO



Ø TUBO	REF	P.V.P
2 a 12 mm.	PT 12	19,22 €
2 a 25 mm.	PT 25	30,18 €

CUCHILLAS

RECAMBIOS PARA LOS CORTATUBOS

REF	UDS.	P.V.P
TOTBMW C	5	2,77 €
PT 12 C	5	5,87 €
PT 25 C	5	11,03 €

DEPOSITOS

REF.	LITROS	P.V.P. SEGÚN Nº DE CONEXIONES			
		2	4	4 INOX	5
05SBCV	0,5	33,13 €	X	X	X
1 SBCV	1	33,13 €	57,31 €	X	X
2 SBCV	2,5	35,81 €	60,00 €	X	X
5 SBCV	5	58,21 €	82,37 €	323,88 €	CONS.
7 SBCV	7	68,04 €	92,22 €	X	
10 SBCV	10	X	146,84 €	X	X
12 SBCV	12	101,17 €	125,35 €	334,66 €	CONS.
15 SBCV	15	X	166,56 €	X	X
24 SBCV	24	X	220,26 €	593,76 €	X
50 SBCV	50	X	479,92 €	X	X
100 SBCV	100	X	623,17 €	X	X



SOPORTE DEPOSITO	
STSB	12,75 €



V56

RACOR CON VALVULA DE RETENCION

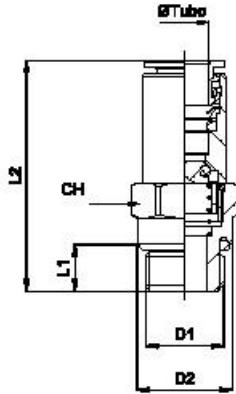

ARTICULO	Ø TUBO	D ¹	D ²	L ¹	L ²	CH	UDS.	P.V.P.
V5604M5	4	M5	8	4	37,5	9	10	7,66 €
V560418	4	1/8	13	6	31	11	10	7,66 €
V560618	6	1/8	13	6	38	13	10	7,66 €
V560614	6	1/4	16	8	39	14	10	8,25 €
V560818	8	1/8	13	6	39	15	10	8,02 €
V560814	8	1/4	16	8	40	16	10	8,25 €
V561014	10	1/4	16	8	43	18	10	10,14 €
V561038	10	3/8	20	9	43	18	10	10,72 €
V561212	12	1/2	25	10	47	22	10	13,17 €
V561412	14	1/2	25	10	54	25	10	14,36 €

CARACTERISTICAS TECNICAS	
FLUIDO	AIRE COMPRIMIDO
PRESION	0,5 ÷ 12 bar
TEMPERATURA	-20° C ÷ +70° C
ROSCA	CILINDRICA: UNI – ISO 228/1 (BSP) / METRICA: ISO R/262
TUBO DE CONEXIÓN	NYLON, POLIURETANO Y RILSAN CALIBRADO.
MATERIAL	CUERPO: LATON NIQUELADO VALVULA: LATON JUNTAS: GOMA NITRILICA (NBR) PINZA DE SUJECCION: ACERO INOXIDABLE

SLT

SELECTOR DE CIRCUITO

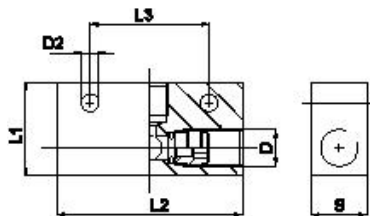

ARTICULO	D	D ²	L ¹	L ²	L ³	S	UDS.	P.V.P.
SLT601818	1/8	4,5	25	50	32	15	5	12,59 €
SLT601414	1/4	5,5	30	52	35	25	5	13,97 €

CARACTERISTICAS TECNICAS	
FLUIDO	AIRE COMPRIMIDO
PRESION	0,5 ÷ 12 bar
TEMPERATURA	-20° C ÷ +70° C
ROSCA CILINDRICA	UNI – ISO 228/1 (BSP)
MATERIAL	CUERPO: ALUMINIO ANODIZADO JUNTAS: GOMA NITRILICA (NBR)

V57 / V58

REGULADOR DE PRESION CON MANOMETRO INCORPORADO

VERSION	SIMBOLO	TIPO
En línea, con conexión en adaptador rápido		V57
A 90°, con entrada en rosca macho y salida con adaptador rápido		V58



V57



V58

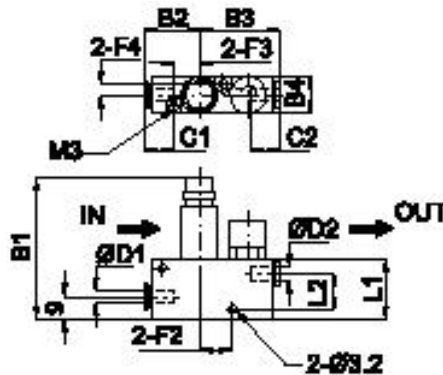

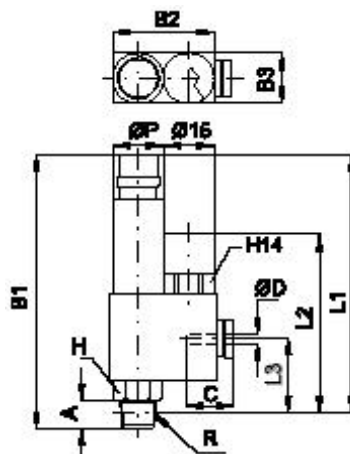

Artículo	Tubo	Tubo	Uds.	P.V.P
V570404	4	4	5	111,24 €
V570606	6	6	5	113,97 €
V570808	8	8	5	125,73 €



Artículo	Tubo	Tubo	Uds.	P.V.P
V5804M5	4	M5	10	55,80 €
V580418	4	1/8	10	61,10 €
V5806M5	6	M5	10	58,56 €
V580618	6	1/8	10	63,89 €
V580614	6	1/4	10	67,64 €
V580818	8	1/8	10	66,66 €
V580814	8	1/4	10	70,43 €

CARACTERISTICAS TECNICAS	
FLUIDO	AIRE COMPRIMIDO
PRESION	1 ÷ 8 bar
TEMPERATURA	0°C ÷ + 60°C
ROSCA	CONICA: UNI – ISO 7 / 1 (BSPT) / METRICA: ISO R/262
TUBO DE CONEXION	NYLON, POLIURETANO Y RILSAN CALIBRADO
TOLERANCIA DEL TUBO	± 0,05 mm.
MATERIAL	CUERPO: RESINA ACETALICA ROSCA METALICA: LATON NIQUELADO PINZA DE SUJECCION : ACERO INOXIDABLE JUNTAS: GOMA NITRILICA (NBR)

PR18 PRESOSTATO REGULABLE

VERSION	SIMBOLO	ARTICULO	P.V.P
Normalmente abierto		PR18A	44,64 €
Normalmente cerrado		PR18C	44,64 €

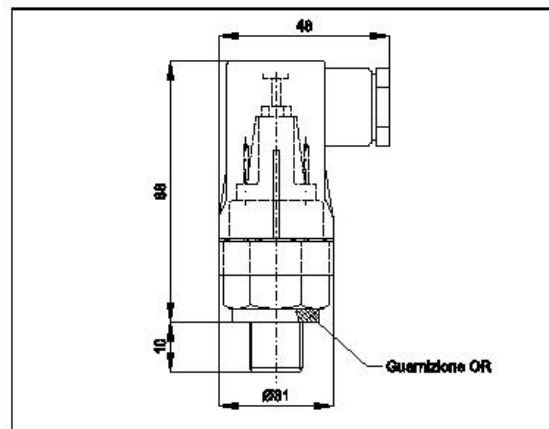
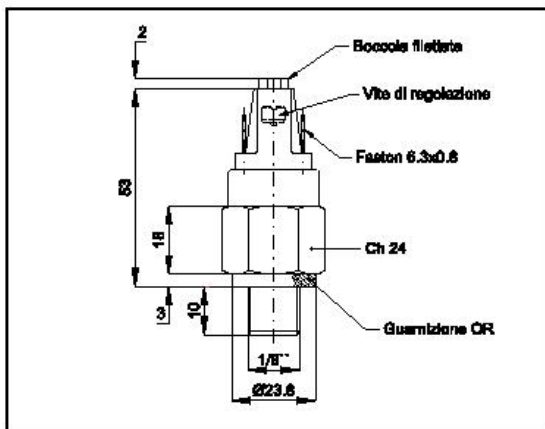

CARACTERISTICAS TECNICAS	
FLUIDO	AIRE COMPRIMIDO FILTRADO O SIN LUBRIFICAR
CAMPO DE TRABAJO	1 ÷ 10 bar
PRESION MAXIMA	30 bar
CONEXIÓN	1/8 GAS (BSP)
TENSION MAXIMA	250 Vca
TENSION DE TRABAJO	220 Vca
CARGA RESISTIVA	6 A
CARGA INDUCTIVA A COS. Ø 0,4	2 A
CARGA RESISTIVA A 24 Vdc.	4 A
CARGA INDUCTIVA S/D 50 m/s	1 A / 24 Vdc
CLASE DE AISLAMIENTO	GRUPO C SEGÚN VDE 0110
PROTECCION SIN CAPUCHON	IP 0
PROTECCION CON CAPUCHON	IP 65
CAMBIO EN MITAD DE ESCALA	10 % V.E.
TEMPERATURA DE TRABAJO	-10 ° C ÷ +80 ° C
Nº MAX. DE GOLPES A 25° C	120 / 1' EN DIAFRAGMA
VIDA MECANICA	10v CICLOS
CIERRE DE TORSION	2 KMG
MATERIALES	CUERPO CH24: ALUMINIO ANODIZADO AZUL CONTACTO ELECTRIC PLATEADO: Ag. CdO MEMBRANA: HNBR CAPUCHON: NYLON NEGRO SOSTENEDOR DE CONTACTO: POCAN

PEDALES

ACP

PEDAL NEUMATICO

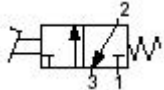
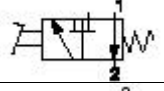
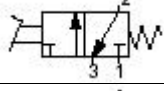
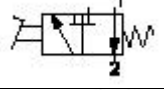
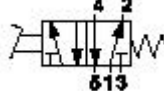
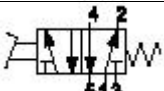
VERSION	SIMBOLO	ARTICULO	P.V.P.
3/2 N.C. CONEXIÓN RAPIDA PARA TUBO Ø 4 mm.		ACP04132C	61,88 €
3/2 N.A. CONEXIÓN RAPIDA PARA TUBO Ø 4 mm.		ACP04132A	69,44 €
3/2 N.C. CONEXIÓN M5		ACP05132C	58,94 €
3/2 N.A. CONEXIÓN M5		ACP05132A	58,94 €
5/2 MONOESTABLE. CONEXIÓN RAPIDA PARA TUBO Ø 4 mm.		ACP041520	80,72 €
5/2 MONOESTABLE. CONEXIÓN M5		ACP051520	73,04 €
TAPA PROTECCION AMARILLA		ACP0405P	11,54 €

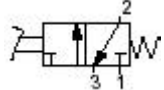
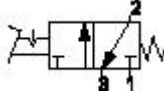
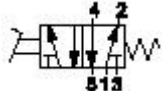
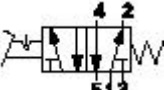

Válvula de salida con rosca de 1/4.

VERSION	SIMBOLO	ARTICULO	P.V.P.
3/2 N.C. MONOESTABLE		ACP14132C	81,99 €
3/2 N.C. BIESTABLE		ACP14232C	87,12 €
5/2 MONOESTABLE		ACP141520	79,43 €
5/2 BIESTABLE		ACP142520	84,56 €

VÁLVULAS DE SEGURIDAD

Homologada según norma ISO 4126/1 DIR97/23/CE

CARACTERÍSTICAS TÉCNICAS	
MATERIALES	CUERPO : LATON
	MUELLE : ACERO (BAJO PEDIDO EN ACERO INOXIDABLE)
	OR: EN NBR 70 (BAJO PEDIDO EN VITON)
TEMPERATURA	ESTÁNDAR: -10°C - +90°C
	CON JUNTA DE VITON: -10°C - +250°C

VSN TARADAS CON ANILLA



CODIGO	ROSCA	P.V.P
VSN 1/8	1/8	8,01 €
VSN 1/4	1/4	8,01 €
VSN 3/8	3/8	9,02 €
VSN 1/2	1/2	12,30 €
VSN 3/4	3/4	49,76 €
VSN 1"	1"	65,74 €

VS REGULABLES

CAMPOS DE REGULACIÓN: 3-7, 8-12 Y 13-16



CODIGO	ROSCA	P.V.P
VS 1/8	1/8	6,14 €
VS 1/4	1/4	6,97 €
VS 3/8	3/8	10,69 €
VS 1/2	1/2	13,51 €
VS 3/4	3/4	31,44 €
VS 1"	1"	44,62 €