

X2

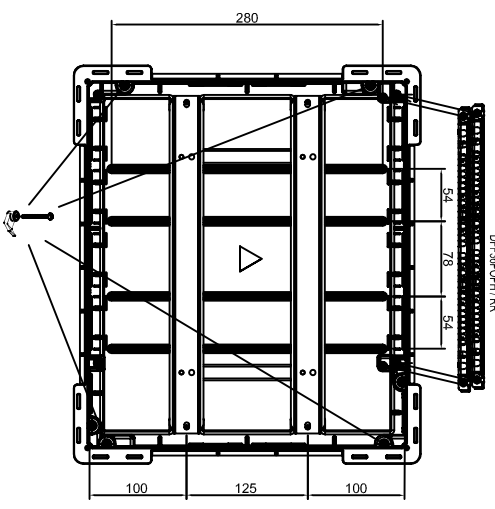
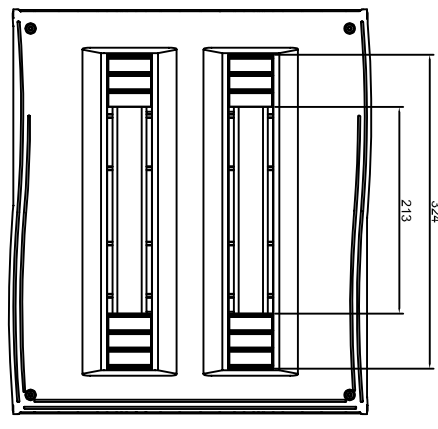
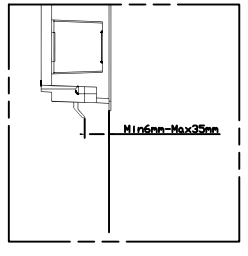
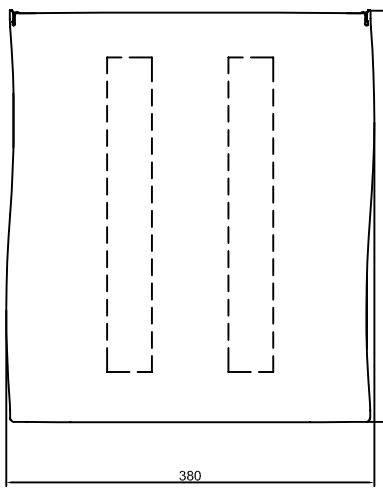
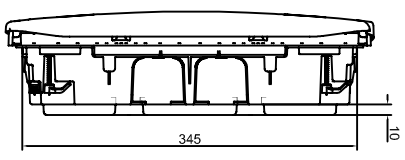
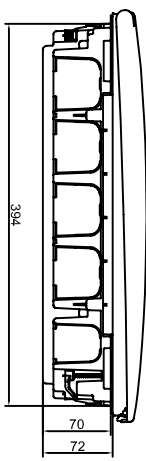
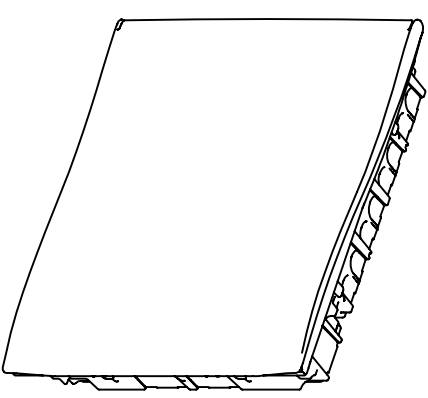

TIPO/TYPE	(N) (mm²)	(E) (mm²)
DFE36-/RR	1x (12x2 5,6mm²+12x4 1,0mm²+) 1x (1x10,25mm²+1x1(6,35mm²))	1x (12x2 5,6mm²+12x4 1,0mm²+) 1x (1x10,25mm²+1x1(6,35mm²))
DFE42-/RR	1x (2x2 5,6mm²+12x4 1,0mm²+) 1x (1x10,25mm²+1x1(6,35mm²))	1x (2x2 5,6mm²+12x4 1,0mm²+) 1x (1x10,25mm²+1x1(6,35mm²))
DFE54-/RR	1x (18x2 5,6mm²+16x(4 1,0mm²+) 2x (1x10,25mm²+2x(1(6,35mm²))	1x (18x2 5,6mm²+16x(4 1,0mm²+) 2x (1x10,25mm²+2x(1(6,35mm²))
DFE64-/RR	2x (12x2 5,6mm²+12x4 1,0mm²+) 1x (1x10,25mm²+1x1(6,35mm²))	2x (12x2 5,6mm²+12x4 1,0mm²+) 1x (1x10,25mm²+1x1(6,35mm²))

In<125A

Queda terminantemente prohibida la reproducción o divulgación, total o parcial, de este plano sin previa autorización por escrito de IDE Electric SL.  
Total or partial reproduction or disclosure of this document is strictly forbidden without the prior written approval of IDE Electric SL.

MODIFICACION / MODIFICATION	NOMBRE / NAME	FECHA / DATE	DESCRIPCION DEL CAMBIO / CHANGE DESCRIPTION
1	JMABRD	20/10/2020	DFE36PO/PH - DFE72PO/PH/RR

PROYECTO/PROJECT: DIAMANT

REVISIONES/REVISIONS: SUSTITUIVO/REPLACE

EDICION / EDITION: Nº 1



160.06.004

X2

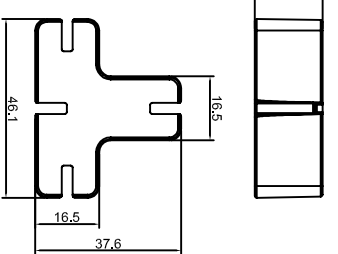
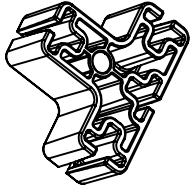
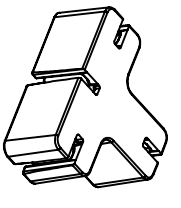
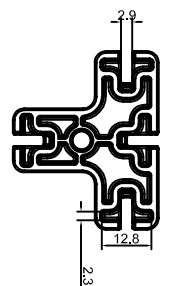

MODIFICACION / MODIFICATION	NOMBRE / NAME	FECHA / DATE	DESCRIPCION DEL CAMBIO / CHANGE DESCRIPTION
1	JMABRD	02/10/2020	PIEZA ENLACE DFE

PROYECTO/PROJECT: DIAMANT

REVISIONES/REVISIONS: SUSTITUIVO/REPLACE

EDICION / EDITION: Nº 1



160.06.016

AK 210x297

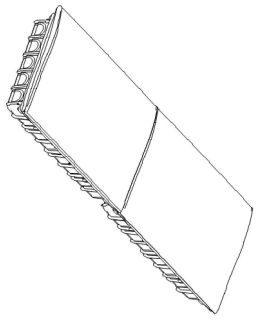
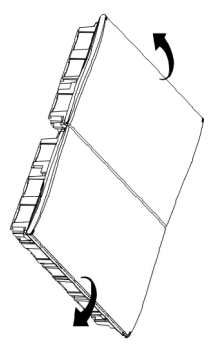

MODIFICACION / MODIFICATION	NOMBRE / NAME	FECHA / DATE	DESCRIPCION DEL CAMBIO / CHANGE DESCRIPTION
1	JMABRD	20/10/2020	DFE72PO/PH - DFE72PO/PH/RR

PROYECTO/PROJECT: DIAMANT

REVISIONES/REVISIONS: SUSTITUIVO/REPLACE

EDICION / EDITION: Nº 1

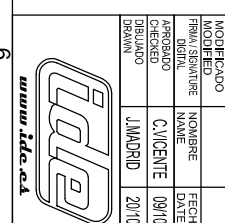

160.06.018

AK 210x297